

## N-channel 200 V, 0.29 $\Omega$ typ., 9 A, STripFET™ Power MOSFET in a TO-220 package

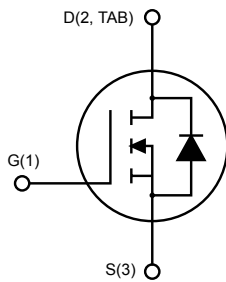

AM01475v1\_noZen

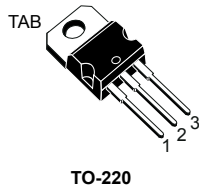

### Product status link

[IRF630](#)

### Product summary

<b>Order code</b>	IRF630
<b>Marking</b>	IRF630
<b>Package</b>	TO-220
<b>Packing</b>	Tube

### Features

Order code	$V_{DS}$	$R_{DS(on)}$ max.	$I_D$
IRF630	200 V	0.40 $\Omega$	9 A

- Extremely high dv/dt capability
- Very low intrinsic capacitance
- Gate charge minimized

### Applications

- Switching applications

### Description

This Power MOSFET series realized with STMicroelectronics unique STripFET™ process has specifically been designed to minimize input capacitance and gate charge. It is therefore suitable as primary switch in advanced high-efficiency isolated DC-DC converters.

# 1 Electrical ratings

**Table 1. Absolute maximum ratings**

Symbol	Parameter	Value	Unit
$V_{\text{DDS}}$	Drain-source voltage ( $V_{\text{GS}} = 0 \text{ V}$ )	200	V
$V_{\text{DGR}}$	Drain-gate voltage ( $R_{\text{GS}} = 20 \text{ k}\Omega$ )	200	V
$V_{\text{GS}}$	Gate-source voltage	$\pm 20$	V
$I_{\text{D}}$	Drain current (continuous) at $T_{\text{C}} = 25 \text{ }^\circ\text{C}$	9	A
	Drain current (continuous) at $T_{\text{C}} = 100 \text{ }^\circ\text{C}$	6.5	A
$I_{\text{DM}}^{(1)}$	Drain current (pulsed)	36	A
$P_{\text{TOT}}$	Total power dissipation at $T_{\text{C}} = 25 \text{ }^\circ\text{C}$	120	W
$E_{\text{AS}}^{(2)}$	Single pulse avalanche energy	110	mJ
$dv/dt^{(3)}$	Drain-body diode dynamic $dv/dt$ ruggedness	5.8	V/ns
$T_{\text{stg}}$	Storage temperature range	-65 to 175	$^\circ\text{C}$
$T_{\text{J}}$	Operating junction temperature range		

1. Pulse width is limited by safe operating area.
2. Starting  $T_{\text{J}} = 25 \text{ }^\circ\text{C}$ ,  $I_{\text{D}} = 4.5 \text{ A}$
3.  $I_{\text{SD}} = 9 \text{ A}$ ,  $di/dt = 520 \text{ A}/\mu\text{s}$ ,  $V_{\text{DD}} = 50 \text{ V}$ ,  $T_{\text{J}} < T_{\text{Jmax}}$

**Table 2. Thermal data**

Symbol	Parameter	Value	Unit
$R_{\text{thj-case}}$	Thermal resistance junction-case	1.26	$^\circ\text{C}/\text{W}$
$R_{\text{thj-amb}}$	Thermal resistance junction-ambient	62.5	$^\circ\text{C}/\text{W}$

## 2 Electrical characteristics

$T_{CASE} = 25\text{ °C}$  unless otherwise specified

**Table 3. On/off states**

Symbol	Parameter	Test conditions	Min.	Typ.	Max.	Unit
$V_{(BR)DSS}$	Drain-source breakdown voltage	$V_{GS} = 0\text{ V}$ , $I_D = 250\text{ }\mu\text{A}$	200			V
$I_{DSS}$	Zero gate voltage drain current	$V_{GS} = 0\text{ V}$ , $V_{DS} = 200\text{ V}$			1	$\mu\text{A}$
		$V_{GS} = 0\text{ V}$ , $V_{DS} = 200\text{ V}$ , $T_C = 125\text{ °C}^{(1)}$			100	$\mu\text{A}$
$I_{GSS}$	Gate body leakage current	$V_{DS} = 0\text{ V}$ , $V_{GS} = 20\text{ V}$			$\pm 100$	nA
$V_{GS(th)}$	Gate threshold voltage	$V_{DS} = V_{GS}$ , $I_D = 250\text{ }\mu\text{A}$	2	3	4	V
$R_{DS(on)}$	Static drain-source on-resistance	$V_{GS} = 10\text{ V}$ , $I_D = 4.5\text{ A}$		0.29	0.40	$\Omega$

1. Defined by design, not subject to production test.

**Table 4. Dynamic**

Symbol	Parameter	Test conditions	Min.	Typ.	Max.	Unit
$C_{iss}$	Input capacitance	$V_{DS} = 25\text{ V}$ , $f = 1\text{ MHz}$ , $V_{GS} = 0\text{ V}$	-	370	-	pF
$C_{oss}$	Output capacitance		-	77	-	pF
$C_{rss}$	Reverse transfer capacitance		-	14	-	pF
$Q_g$	Total gate charge	$V_{DD} = 160\text{ V}$ , $I_D = 9\text{ A}$ $V_{GS} = 0\text{ to }10\text{ V}$ (see Figure 13. Test circuit for gate charge behavior)	-	11.6	-	nC
$Q_{gs}$	Gate-source charge		-	2.2	-	nC
$Q_{gd}$	Gate-drain charge		-	5.5	-	nC

**Table 5. Switching times**

Symbol	Parameter	Test conditions	Min.	Typ.	Max.	Unit
$t_{d(on)}$	Turn-on delay time	$V_{DD} = 100\text{ V}$ , $I_D = 4.5\text{ A}$ , $R_G = 4.7\text{ }\Omega$ , $V_{GS} = 10\text{ V}$ (see Figure 12. Test circuit for resistive load switching times and Figure 17. Switching time waveform)	-	5.6	-	ns
$t_r$	Rise time		-	2.6	-	ns

**Table 6. Source-drain diode**

Symbol	Parameter	Test conditions	Min.	Typ.	Max.	Unit
$V_{SD}^{(1)}$	Forward on voltage	$I_{SD} = 9\text{ A}$ , $V_{GS} = 0\text{ V}$	-		1.5	V
$t_{rr}$	Reverse recovery time	$I_{SD} = 9\text{ A}$ , $di/dt = 100\text{ A}/\mu\text{s}$ ,	-	118.5		ns
$Q_{rr}$	Reverse recovery charge	$V_{DD} = 50\text{ V}$	-	393		nC
$I_{RRM}$	Reverse recovery current	(see <a href="#">Figure 17. Switching time waveform</a> )	-	6.6		A

1. Pulsed: pulse duration = 300  $\mu\text{s}$ , duty cycle 1.5%

## 2.1 Electrical characteristics (curves)

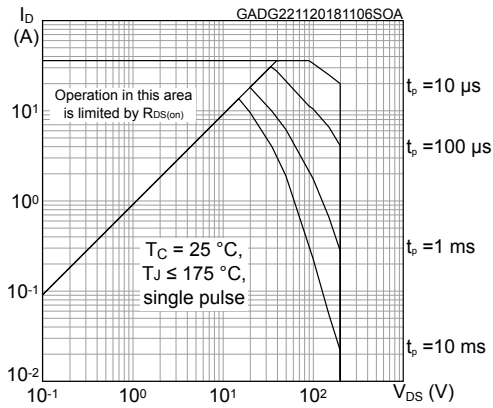
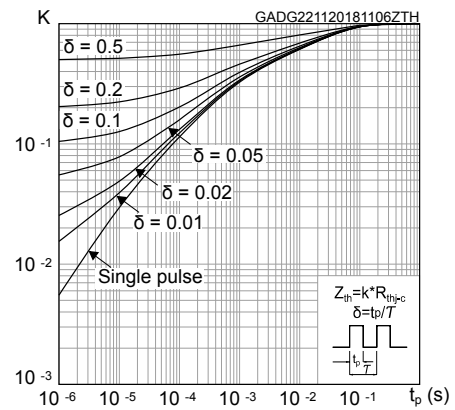
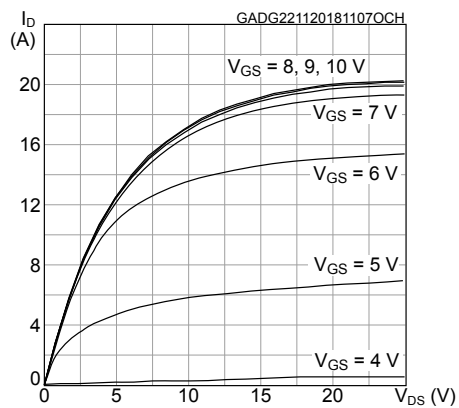
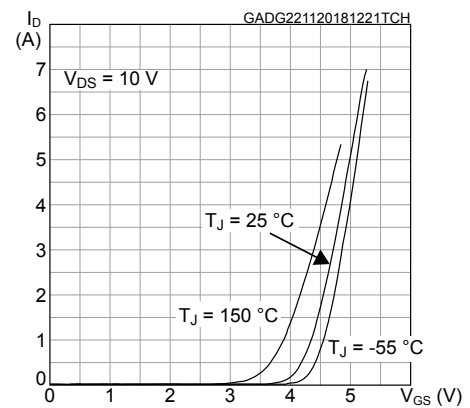
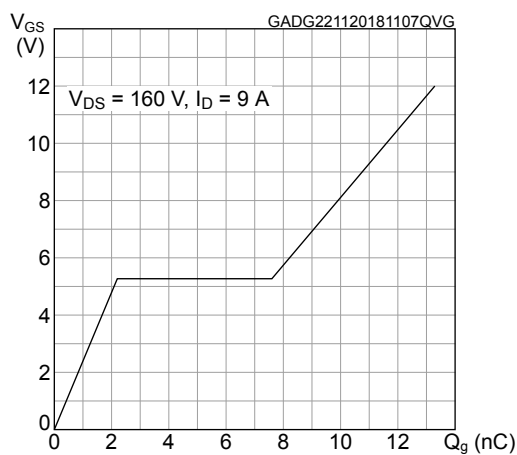
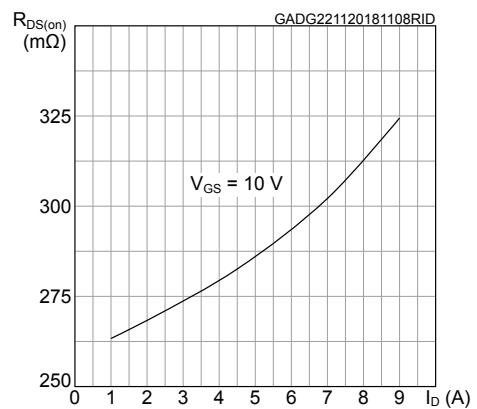
**Figure 1. Safe operating area**

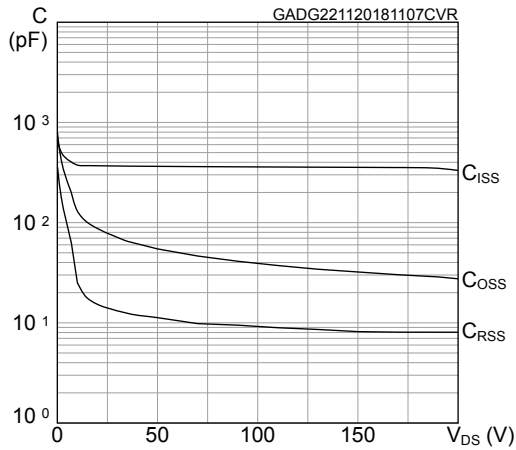
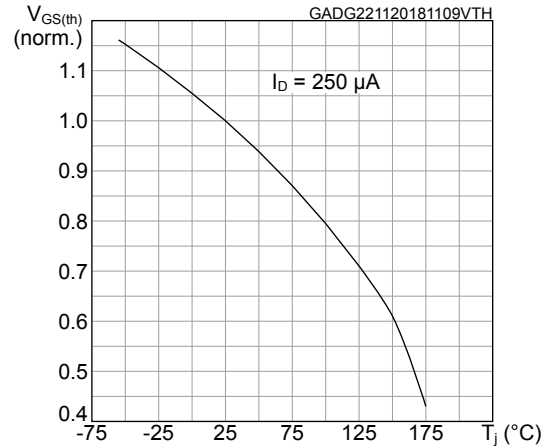
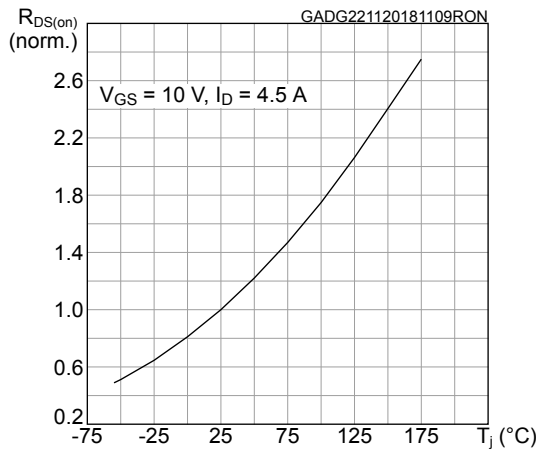
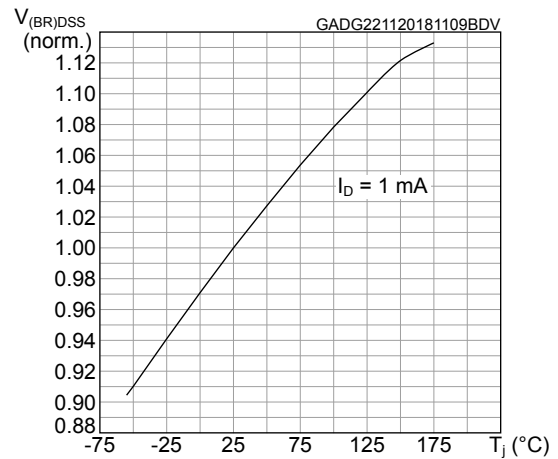
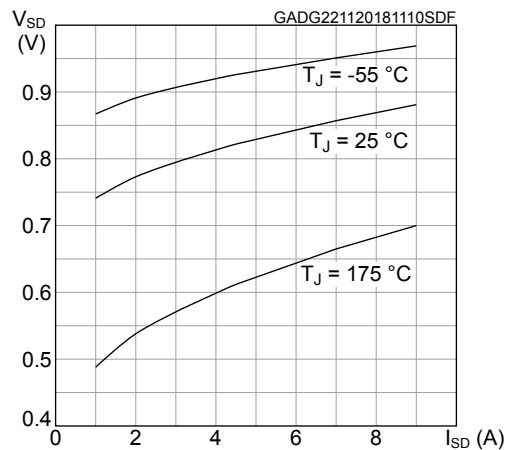
**Figure 2. Thermal impedance**

**Figure 3. Output characteristics**

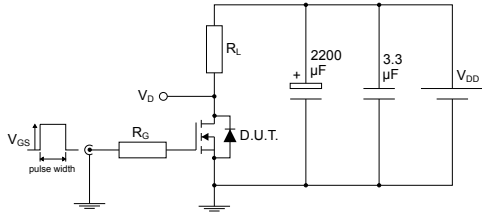
**Figure 4. Transfer characteristics**

**Figure 5. Gate charge vs gate-source voltage**

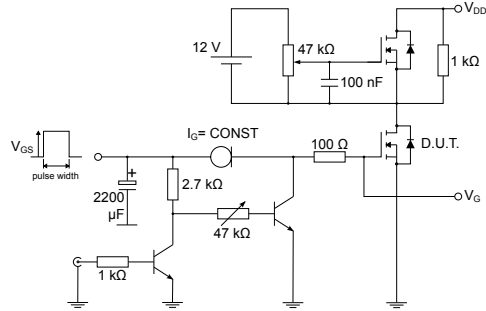
**Figure 6. Static drain-source on-resistance**

**Figure 7. Capacitance variations**

**Figure 8. Normalized gate threshold voltage vs temperature**

**Figure 9. Normalized on-resistance vs temperature**

**Figure 10. Normalized V\_(BR)DSS vs temperature**

**Figure 11. Source-drain diode forward characteristics**

### 3 Test circuits

**Figure 12. Test circuit for resistive load switching times**

AM01468v1

**Figure 13. Test circuit for gate charge behavior**

AM01469v1

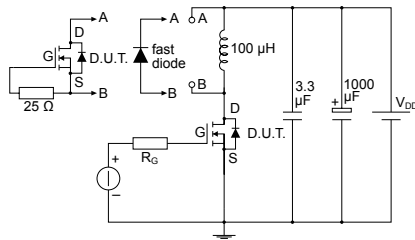
**Figure 14. Test circuit for inductive load switching and diode recovery times**

AM01470v1

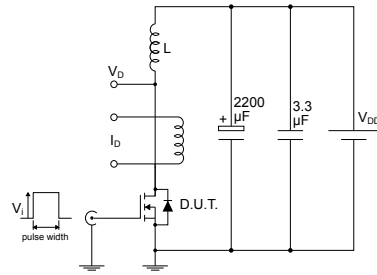
**Figure 15. Unclamped inductive load test circuit**

AM01471v1

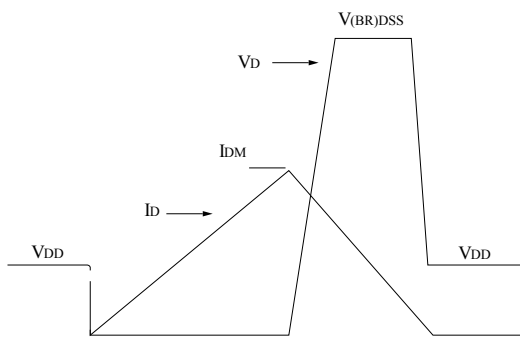
**Figure 16. Unclamped inductive waveform**

AM01472v1

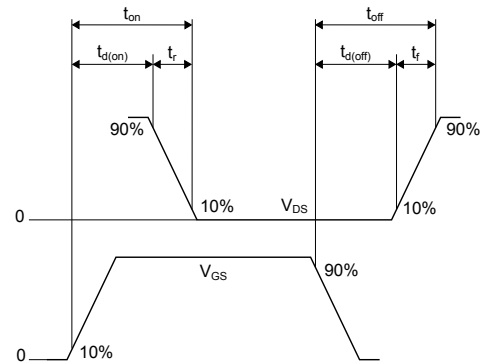
**Figure 17. Switching time waveform**

AM01473v1

## 4 Package information

---

In order to meet environmental requirements, ST offers these devices in different grades of **ECOPACK®** packages, depending on their level of environmental compliance. ECOPACK® specifications, grade definitions and product status are available at: [www.st.com](http://www.st.com). ECOPACK® is an ST trademark.

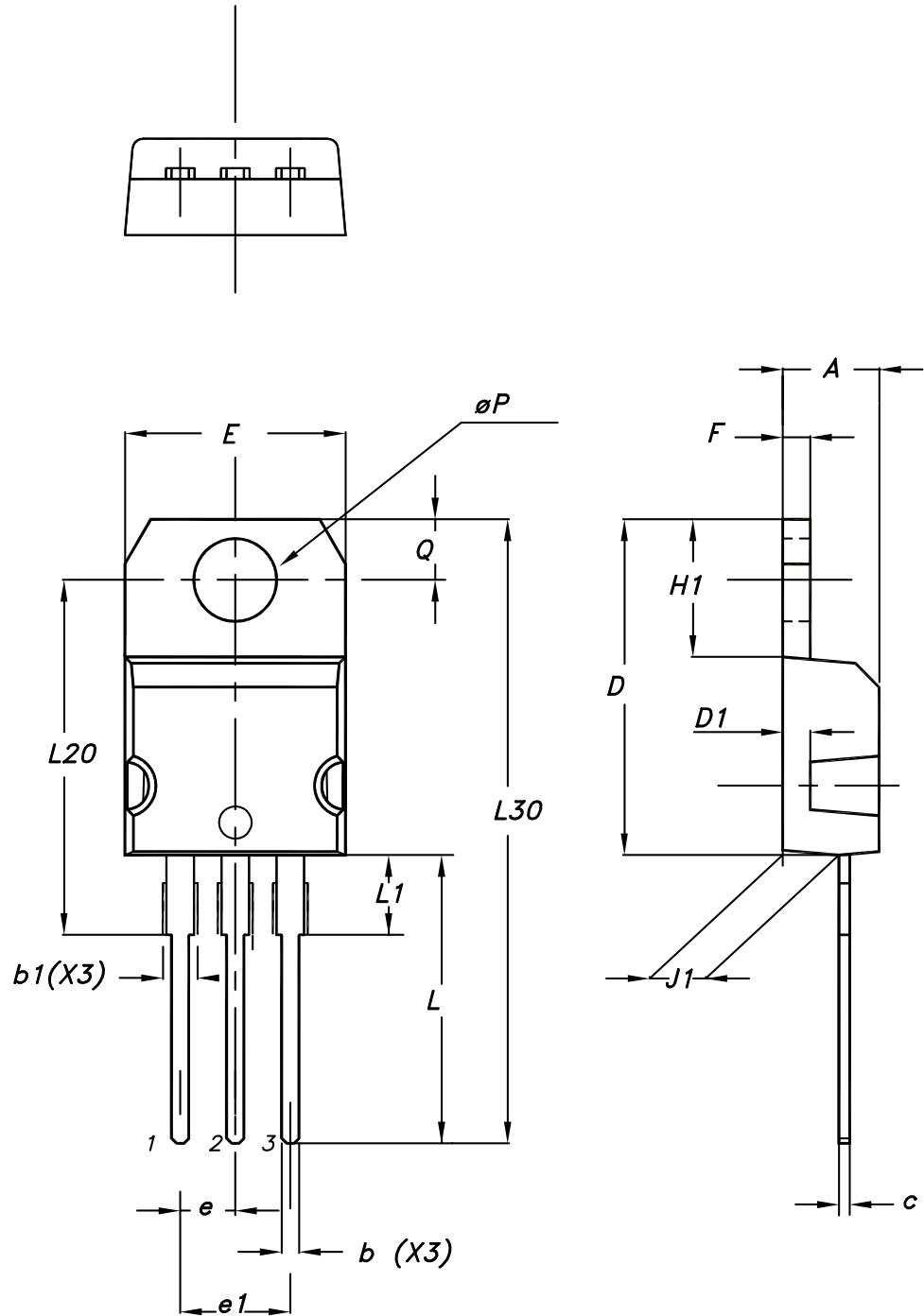

**4.1 TO-220 type A package information**
**Figure 18. TO-220 type A package outline**

0015988\_typeA\_Rev\_22

**Table 7. TO-220 type A package mechanical data**

Dim.	mm		
	Min.	Typ.	Max.
A	4.40		4.60
b	0.61		0.88
b1	1.14		1.55
c	0.48		0.70
D	15.25		15.75
D1		1.27	
E	10.00		10.40
e	2.40		2.70
e1	4.95		5.15
F	1.23		1.32
H1	6.20		6.60
J1	2.40		2.72
L	13.00		14.00
L1	3.50		3.93
L20		16.40	
L30		28.90	
øP	3.75		3.85
Q	2.65		2.95

## Revision history

**Table 8. Document revision history**

Date	Version	Changes
09-Sep-2004	8	Complete version
03-Aug-2006	9	New template, no content change
12-Dec-2018	10	Part number IRF630FP has been moved to a separate datasheet and the document has been updated accordingly. Minor text changes

---

## Contents

<b>1</b>	<b>Electrical ratings</b> .....	<b>2</b>
<b>2</b>	<b>Electrical characteristics</b> .....	<b>3</b>
<b>2.1</b>	<b>Electrical characteristics (curves)</b> .....	<b>5</b>
<b>3</b>	<b>Test circuits</b> .....	<b>7</b>
<b>4</b>	<b>Package information</b> .....	<b>8</b>
<b>4.1</b>	<b>TO-220 type A package information</b> .....	<b>8</b>
	<b>Revision history</b> .....	<b>11</b>

**IMPORTANT NOTICE – PLEASE READ CAREFULLY**

STMicroelectronics NV and its subsidiaries (“ST”) reserve the right to make changes, corrections, enhancements, modifications, and improvements to ST products and/or to this document at any time without notice. Purchasers should obtain the latest relevant information on ST products before placing orders. ST products are sold pursuant to ST’s terms and conditions of sale in place at the time of order acknowledgement.

Purchasers are solely responsible for the choice, selection, and use of ST products and ST assumes no liability for application assistance or the design of Purchasers’ products.

No license, express or implied, to any intellectual property right is granted by ST herein.

Resale of ST products with provisions different from the information set forth herein shall void any warranty granted by ST for such product.

ST and the ST logo are trademarks of ST. All other product or service names are the property of their respective owners.

Information in this document supersedes and replaces information previously supplied in any prior versions of this document.

© 2018 STMicroelectronics – All rights reserved

# Mouser Electronics

Authorized Distributor

Click to View Pricing, Inventory, Delivery & Lifecycle Information:

[STMicroelectronics:](#)

[IRF630](#)