

High temperature 20 A SCRs

Datasheet - production data

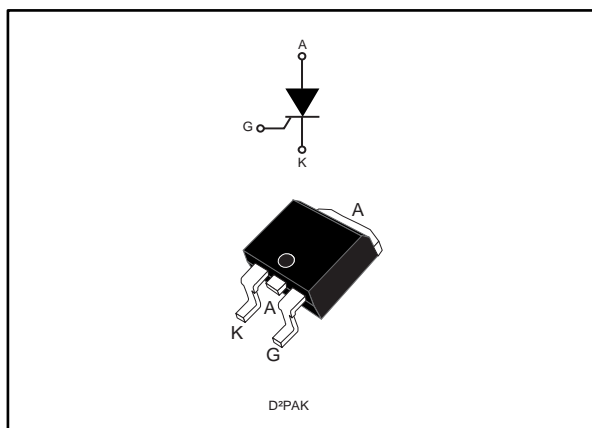

Features

- High junction temperature: $T_j = 150\text{ °C}$
- High noise immunity $dV/dt = 400\text{ V}/\mu\text{s}$ up to 150 °C
- Gate triggering current $I_{GT} = 10\text{ mA}$
- Peak off-state voltage $V_{DRM}/V_{RRM} = 600\text{ V}$
- High turn on current rise $dI/dt = 100\text{ A}/\mu\text{s}$
- ECOPACK[®]2 compliant component

Applications

- Motorbike voltage regulator circuits
- Inrush current limiting circuits
- Motor control circuits and starters
- Light dimmers
- Solid state relays

Description

This device offers high thermal performance during operation of up to 20 A_{RMS} , thanks to a junction temperature of up to 150 °C .

Its D²PAK package allows modern SMD designs as well as compact back to back configuration.

The combination of noise immunity and low gate triggering current allows to design strong and compact control circuits.

Table 1: Device summary

Order code	Package	V_{DRM}/V_{RRM}	I_{GT}
TN2010H-6G	D ² PAK	600 V	10 mA

1 Characteristics

Table 2: Absolute maximum ratings (limiting values), $T_j = 25\text{ °C}$ unless otherwise specified

Symbol	Parameter		Value	Unit	
$I_{T(RMS)}$	RMS on-state current (180 ° conduction angle)	$T_c = 132\text{ °C}$	20	A	
$I_{T(AV)}$	Average on-state current (180 ° conduction angle)	$T_c = 132\text{ °C}$	12.7	A	
		$T_c = 137\text{ °C}$	10		
		$T_c = 140\text{ °C}$	8		
I_{TSM}	Non repetitive surge peak on-state current (T_j initial = 25 °C)	$t_p = 8.3\text{ ms}$	197	A	
		$t_p = 10\text{ ms}$	180		
I^2t	I^2t value for fusing	$t_p = 10\text{ ms}$	162	A^2s	
di/dt	Critical rate of rise of on-state current $I_G = 2 \times I_{GT}$, $t_r \leq 100\text{ ns}$	$f = 60\text{ Hz}$	100	$A/\mu s$	
V_{DSM}/V_{RSM}	Non repetitive surge peak off-state voltage	$t_p = 10\text{ ms}$	700	V	
I_{GM}	Peak gate current	$t_p = 20\text{ }\mu s$	$T_j = 150\text{ °C}$	4	A
$P_{G(AV)}$	Average gate power dissipation	$T_j = 150\text{ °C}$	1	W	
V_{RGM}	Maximum peak reverse gate voltage		5	V	
T_{stg}	Storage junction temperature range		-40 to +150	°C	
T_j	Operating junction temperature range		-40 to +150	°C	

Table 3: Electrical characteristics ($T_j = 25\text{ °C}$ unless otherwise specified)

Symbol	Test conditions		Value	Unit	
I_{GT}	$V_D = 12\text{ V}$, $R_L = 33\text{ }\Omega$	Typ.	5	mA	
		Max.	10		
V_{GT}		Max.	1.3	V	
V_{GD}	$V_D = V_{DRM}$, $R_L = 3.3\text{ k}\Omega$	$T_j = 150\text{ °C}$	Min.	0.1	V
I_H	$I_T = 500\text{ mA}$, gate open		Max.	40	mA
I_L	$I_G = 1.2 \times I_{GT}$		Max.	60	mA
dV/dt	$V_D = 402\text{ V}$, gate open	$T_j = 150\text{ °C}$	Min.	400	$V/\mu s$
t_{gt}	$I_{TM} = 40\text{ A}$, $V_D = 402\text{ V}$, $I_G = 20\text{ mA}$, $(di/dt)_{max} = 0.2\text{ A}/\mu s$		Typ.	1.9	μs
t_q	$I_{TM} = 40\text{ A}$, $V_D = 402\text{ V}$, $(di/dt)_{off} = 30\text{ A}/\mu s$, $V_R = 25\text{ V}$, $dV_D/dt = 40\text{ V}/\mu s$	$T_j = 150\text{ °C}$	Typ.	70	μs

Table 4: Static characteristics

Symbol	Test conditions			Value	Unit
V_{TM}	$I_{TM} = 40 \text{ A}$, $t_p = 380 \mu\text{s}$	$T_j = 25 \text{ }^\circ\text{C}$	Max.	1.6	V
V_{TO}	Threshold voltage	$T_j = 150 \text{ }^\circ\text{C}$	Max.	0.82	
R_D	Dynamic resistance	$T_j = 150 \text{ }^\circ\text{C}$	Max.	17.5	m Ω
I_{DRM} , I_{RRM}	$V_D = V_{DRM}$, $V_R = V_{RRM}$	$T_j = 25 \text{ }^\circ\text{C}$	Max.	5	μA
		$T_j = 125 \text{ }^\circ\text{C}$		2	mA
		$T_j = 150 \text{ }^\circ\text{C}$		3.9	

Table 5: Thermal parameters

Symbol	Parameter			Value	Unit
$R_{th(j-c)}$	Junction to case (DC)		Max.	1.0	$^\circ\text{C/W}$
$R_{th(j-a)}$	Junction to ambient (DC)	$S^{(1)} = 2.5 \text{ cm}^2$	Typ.	45	

Notes:⁽¹⁾S = Copper surface under tab

1.1 Characteristics (curves)

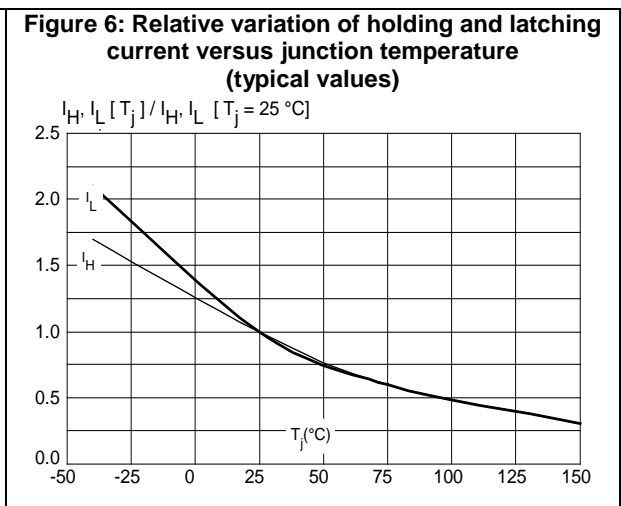
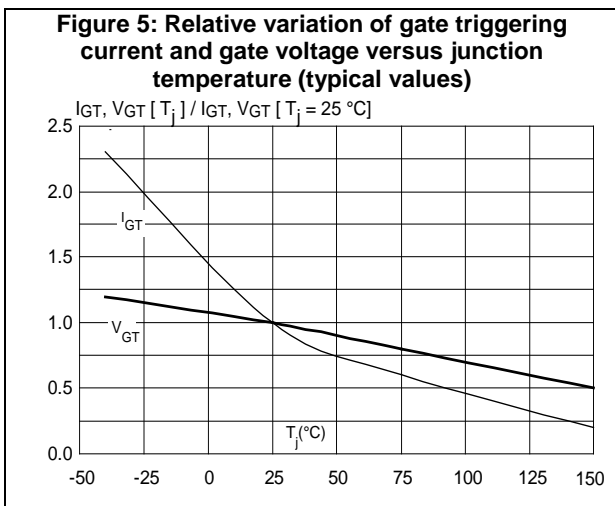
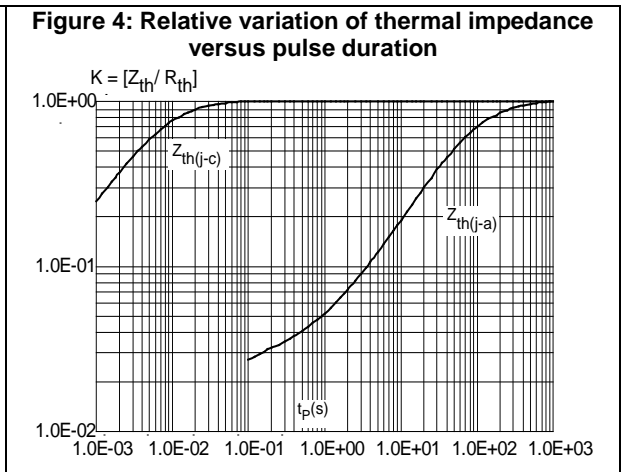
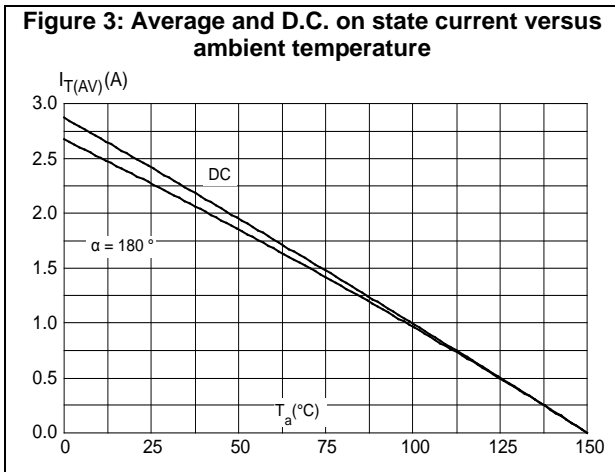
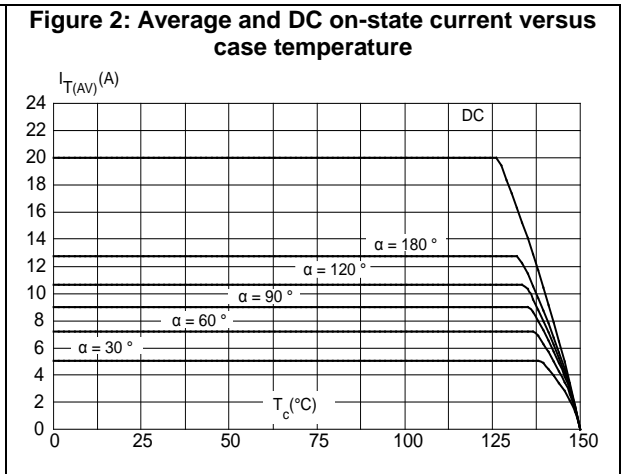
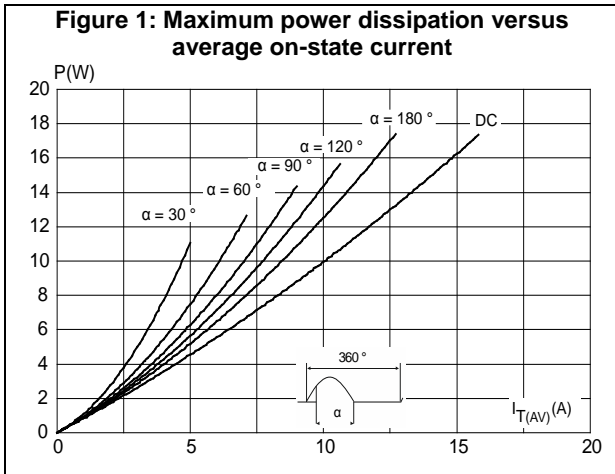

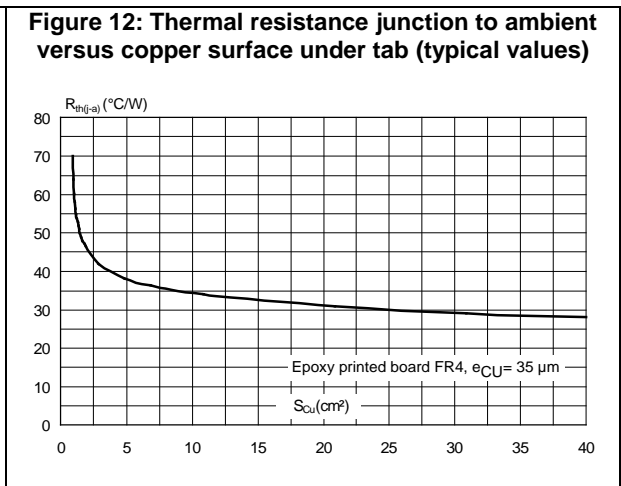
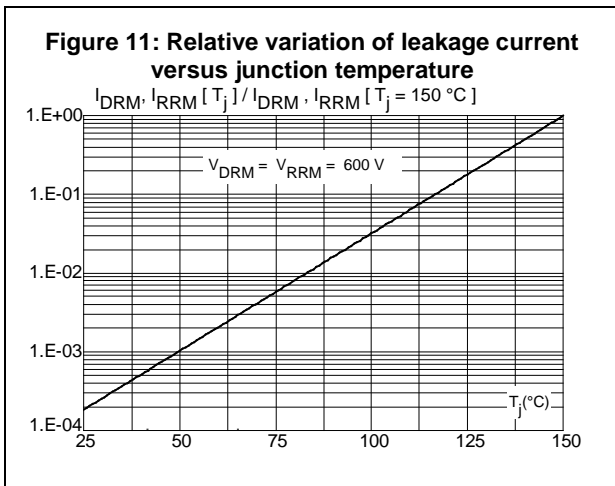
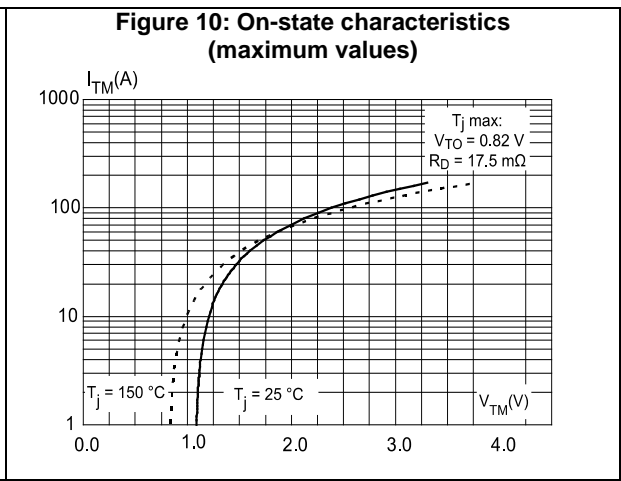
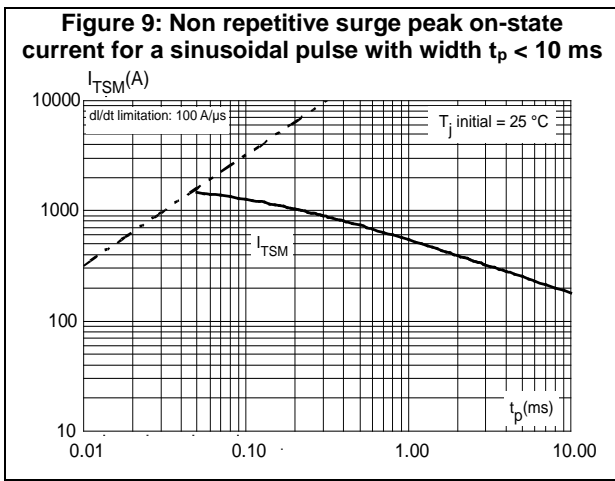
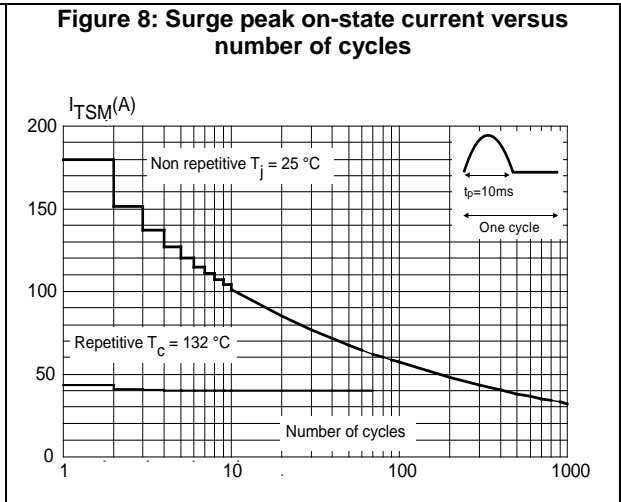
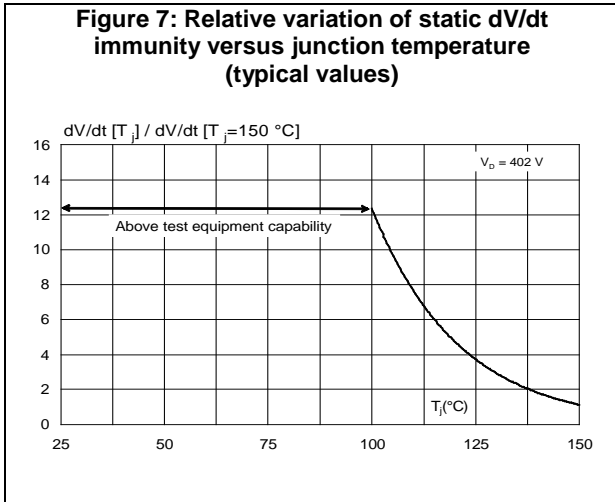

2 Package information

In order to meet environmental requirements, ST offers these devices in different grades of ECOPACK® packages, depending on their level of environmental compliance. ECOPACK® specifications, grade definitions and product status are available at: www.st.com. ECOPACK® is an ST trademark.

- Epoxy meets UL94, V0
- Lead-free, halogen-free package

2.1 D²PAK package information

Figure 13: D²PAK package outline

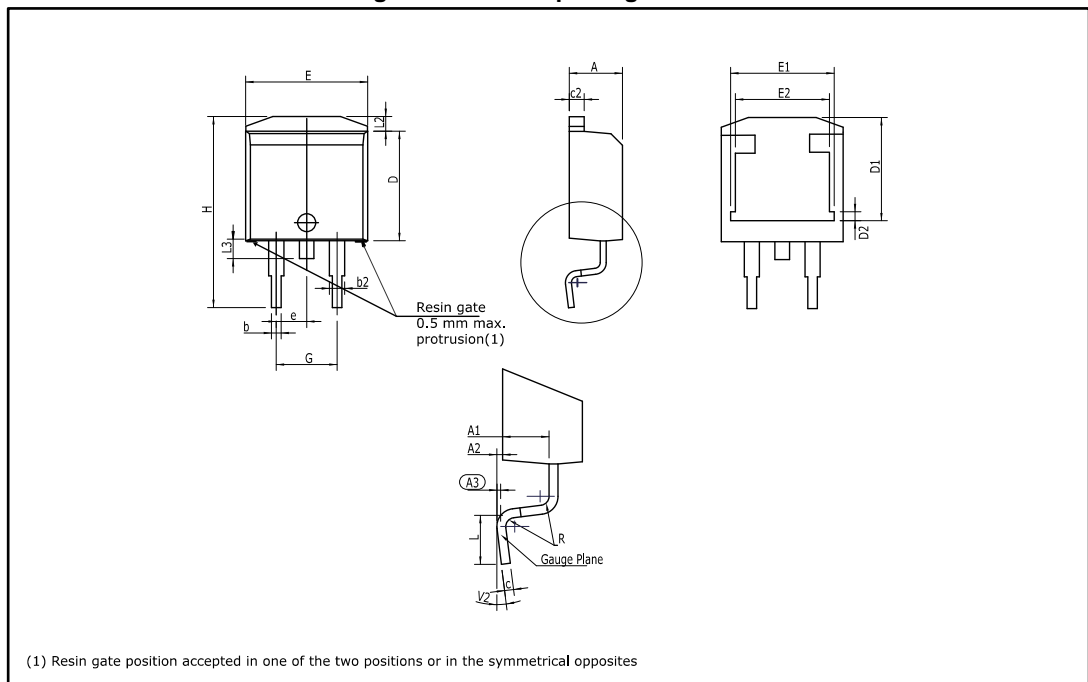

Table 6: D²PAK package mechanical data

Ref.	Dimensions					
	Millimeters			Inches ⁽¹⁾		
	Min.	Typ.	Max.	Min.	Typ.	Max.
A	4.30		4.60	0.1693		0.1811
A1	2.49		2.69	0.0980		0.1059
A2	0.03		0.23	0.0012		0.0091
A3		0.25			0.0098	
b	0.70		0.93	0.0276		0.0366
b2	1.25		1.7	0.0492		0.0669
c	0.45		0.60	0.0177		0.0236
c2	1.21		1.36	0.0476		0.0535
D	8.95		9.35	0.3524		0.3681
D1	7.50		8.00	0.2953		0.3150
D2	1.30		1.70	0.0512		0.0669
e	2.54			0.1		
E	10.00		10.28	0.3937		0.4047
E1	8.30		8.70	0.3268		0.3425
E2	6.85		7.25	0.2697		0.2854
G	4.88		5.28	0.1921		0.2079
H	15		15.85	0.5906		0.6240
L	1.78		2.28	0.0701		0.0898
L2	1.27		1.40	0.0500		0.0551
L3	1.40		1.75	0.0551		0.0689
R		0.40			0.0157	
V2	0°		8°	0°		8°

Notes:

⁽¹⁾Dimensions in inches are given for reference only

Figure 14: D²PAK recommended footprint (dimensions are in mm)

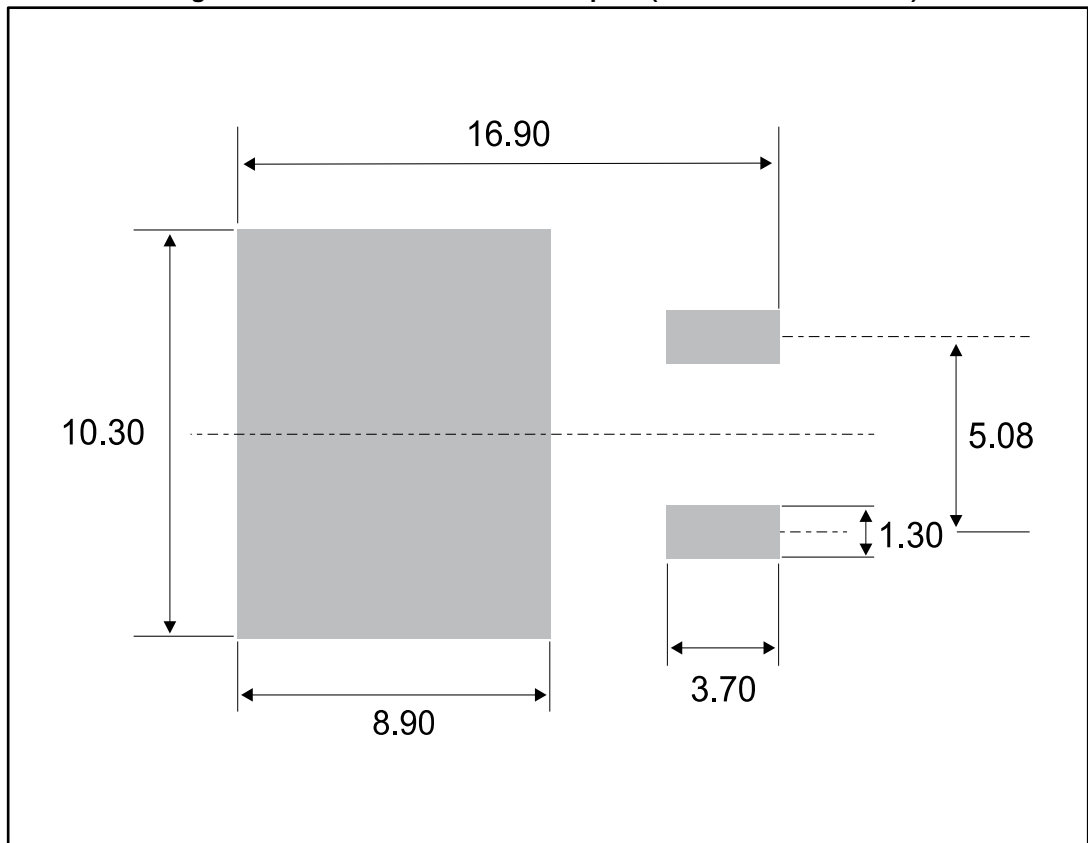

3 Ordering information

Figure 15: Ordering information scheme

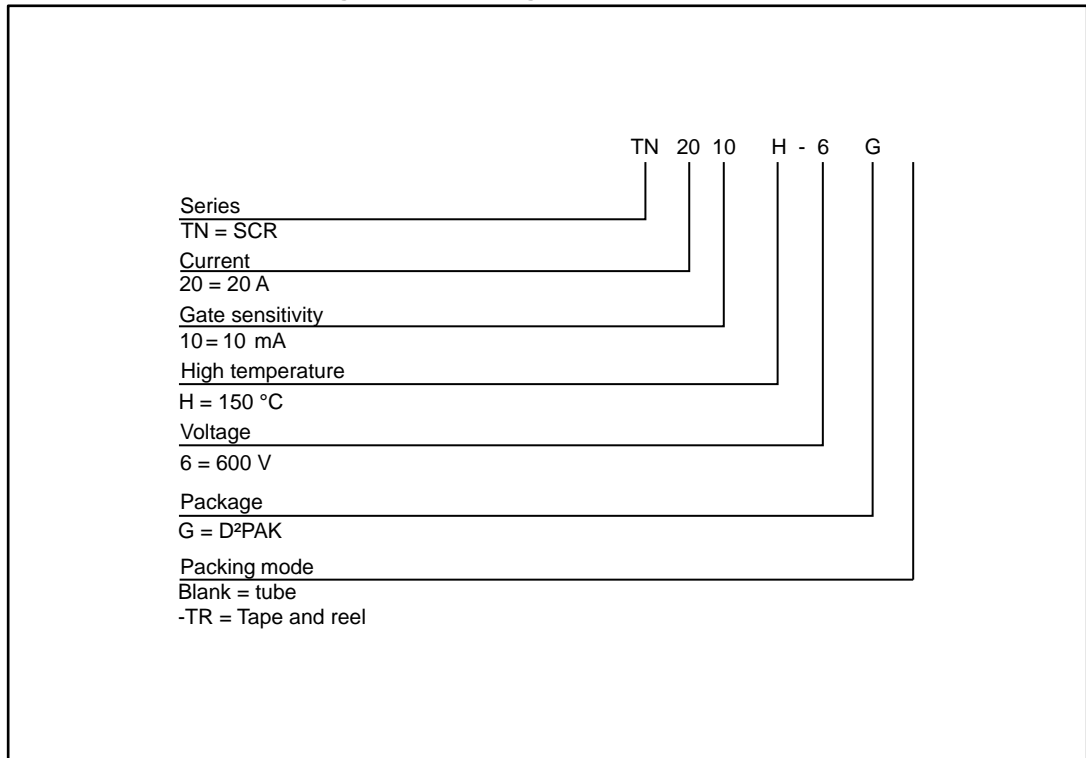

Table 7: Ordering information

Order code	Marking	Package	Weight	Base qty.	Delivery mode
TN2010H-6G	TN2010H6	D ² PAK	2.3 g	50	Tube
TN2010H-6G-TR				1000	Tape and reel

4 Revision history

Table 8: Document revision history

Date	Revision	Changes
24-Aug-2017	1	Initial release.

IMPORTANT NOTICE – PLEASE READ CAREFULLY

STMicroelectronics NV and its subsidiaries ("ST") reserve the right to make changes, corrections, enhancements, modifications, and improvements to ST products and/or to this document at any time without notice. Purchasers should obtain the latest relevant information on ST products before placing orders. ST products are sold pursuant to ST's terms and conditions of sale in place at the time of order acknowledgement.

Purchasers are solely responsible for the choice, selection, and use of ST products and ST assumes no liability for application assistance or the design of Purchasers' products.

No license, express or implied, to any intellectual property right is granted by ST herein.

Resale of ST products with provisions different from the information set forth herein shall void any warranty granted by ST for such product.

ST and the ST logo are trademarks of ST. All other product or service names are the property of their respective owners.

Information in this document supersedes and replaces information previously supplied in any prior versions of this document.

© 2017 STMicroelectronics – All rights reserved

Mouser Electronics

Authorized Distributor

Click to View Pricing, Inventory, Delivery & Lifecycle Information:

[STMicroelectronics:](#)

[TN2010H-6G-TR](#) [TN2010H-6G](#)