

## High efficiency ultrafast diode

Datasheet - production data

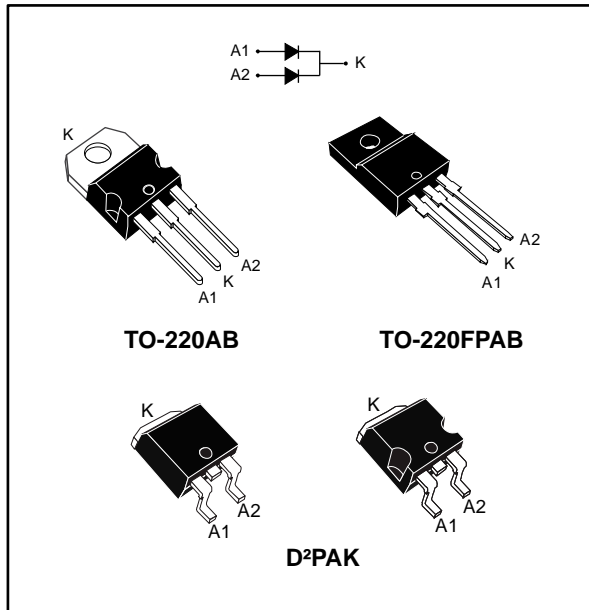

### Description

Dual center tap rectifier suited for switch mode power supply and high frequency DC to DC converters.

Packaged either in TO-220AB, TO-220FPAB and D²PAK, this device is especially intended for use in low voltage, high frequency inverters, free wheeling and polarity protection applications.

Table 1: Device summary

Symbol	Value
$I_{F(AV)}$	Up to 2 x 10 A
$V_{RRM}$	200 V
$T_j$ (max.)	175 °C
$V_F$ (typ.)	0.78 V
$t_{rr}$ (typ.)	21 ns

### Features

- Suited for SMPS
- Low losses
- Low forward and reverse recovery time
- Low leakage current
- High junction temperature
- Insulated package: TO-220FPAB
  - insulating voltage: 2000  $V_{RMS}$  sine
- ECOPACK®2 compliant component for D²PAK on demand

# 1 Characteristics

**Table 2: Absolute ratings (limiting values, per diode, at 25 °C, unless otherwise specified)**

Symbol	Parameter			Value	Unit	
V <sub>RRM</sub>	Repetitive peak reverse voltage			200	V	
I <sub>F(RMS)</sub>	Forward rms current			30	A	
I <sub>F(AV)</sub>	Average forward current $\delta = 0.5$ , square wave	TO-220AB / D <sup>2</sup> PAK	T <sub>C</sub> = 150 °C	Per diode	8	A
			T <sub>C</sub> = 140 °C	Per device	16	
			T <sub>C</sub> = 140 °C	Per diode	10	
			T <sub>C</sub> = 130 °C	Per device	20	
		TO-220FPAB	T <sub>C</sub> = 130 °C	Per diode	8	
			T <sub>C</sub> = 100 °C	Per device	16	
			T <sub>C</sub> = 110 °C	Per diode	10	
			T <sub>C</sub> = 75 °C	Per device	20	
I <sub>FSM</sub>	Surge non repetitive forward current		t <sub>p</sub> = 10 ms sinusoidal	80	A	
T <sub>stg</sub>	Storage temperature range			-65 to +175	°C	
T <sub>j</sub>	Maximum operating junction temperature			175	°C	

**Table 3: Thermal parameter**

Symbol	Parameter			Value	Unit
R <sub>th(j-c)</sub>	Junction to case	TO-220AB / D <sup>2</sup> PAK	Per diode	3.0	°C/W
			Per device	1.9	
		TO-220FPAB	Per diode	5.5	
			Per device	4.5	
R <sub>th(c)</sub>	Coupling	TO-220AB / D <sup>2</sup> PAK		0.8	°C/W
		TO-220FPAB		3.5	

When the diodes 1 and 2 are used simultaneously:

$$\Delta T_{j(\text{diode}1)} = P_{(\text{diode}1)} \times R_{\text{th}(j-c)} (\text{per diode}) + P_{(\text{diode}2)} \times R_{\text{th}(c)}$$

Table 4: Static electrical characteristics (per diode)

Symbol	Parameter	Test conditions		Min.	Typ.	Max.	Unit
$I_R^{(1)}$	Reverse leakage current	$T_j = 25\text{ °C}$	$V_R = V_{RRM}$	-		6	$\mu\text{A}$
		$T_j = 125\text{ °C}$		-	4	60	
$V_F^{(2)}$	Forward voltage drop	$T_j = 25\text{ °C}$	$I_F = 8\text{ A}$	-		1.10	V
		$T_j = 150\text{ °C}$		-	0.78	0.89	
		$T_j = 25\text{ °C}$	$I_F = 16\text{ A}$	-		1.25	
		$T_j = 150\text{ °C}$		-		1.05	

**Notes:**(1) Pulse test:  $t_p = 5\text{ ms}$ ,  $\delta < 2\%$ (2) Pulse test:  $t_p = 380\text{ }\mu\text{s}$ ,  $\delta < 2\%$ 

To evaluate the conduction losses use the following equation:

$$P = 0.73 \times I_{F(AV)} + 0.020 \times I_{F(RMS)}^2$$

Table 5: Dynamic electrical characteristics (per diode)

Symbol	Parameter	Test conditions		Min.	Typ.	Max.	Unit
$t_{rr}$	Reverse recovery time	$T_j = 25\text{ °C}$	$I_F = 1\text{ A}$ , $V_R = 30\text{ V}$ , $dl_F/dt = 100\text{ A}/\mu\text{s}$	-	21	26	ns
$I_{RM}$	Reverse recovery current	$T_j = 125\text{ °C}$	$I_F = 8\text{ A}$ , $V_R = 160\text{ V}$ , $dl_F/dt = 200\text{ A}/\mu\text{s}$	-	6.8	8.8	A
$t_{fr}$	Forward recovery time	$T_j = 25\text{ °C}$	$I_F = 8\text{ A}$ , $dl_F/dt = 100\text{ A}/\mu\text{s}$ $V_{FR} = 1.1 \times V_{Fmax}$	-		160	ns
$V_{FP}$	Forward recovery voltage		$I_F = 8\text{ A}$ , $dl_F/dt = 100\text{ A}/\mu\text{s}$	-	2.4		V

### 1.1 Characteristics (curves)

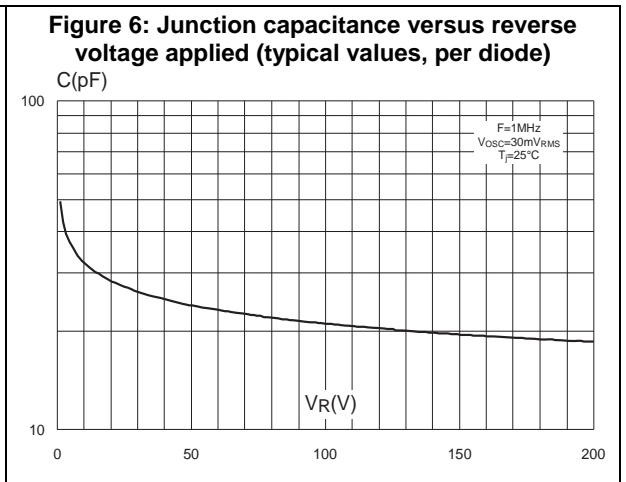
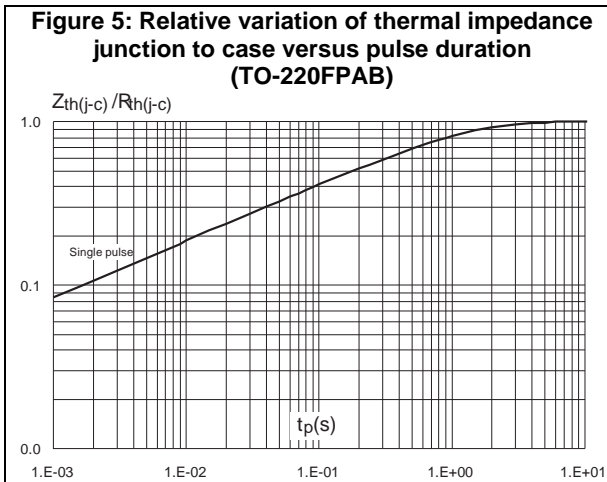
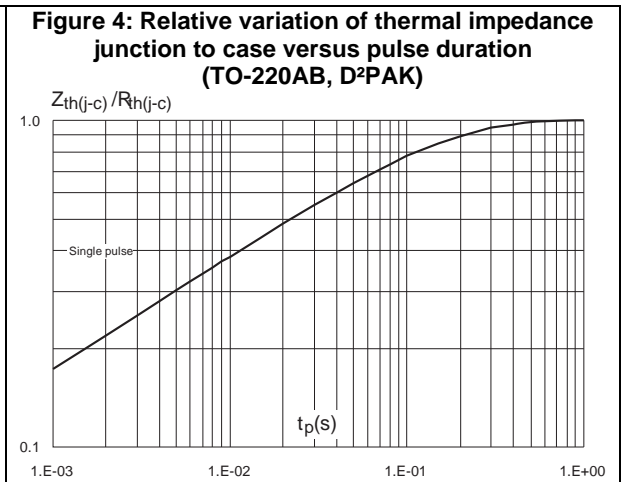
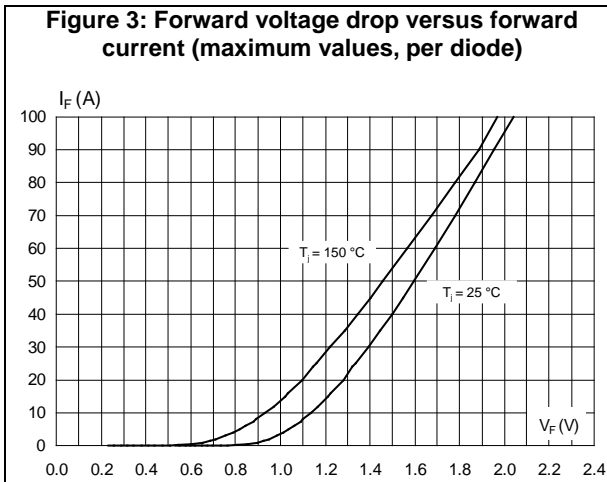
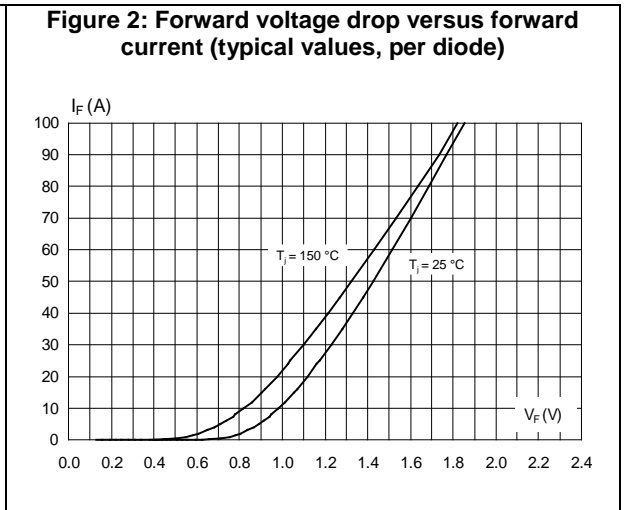
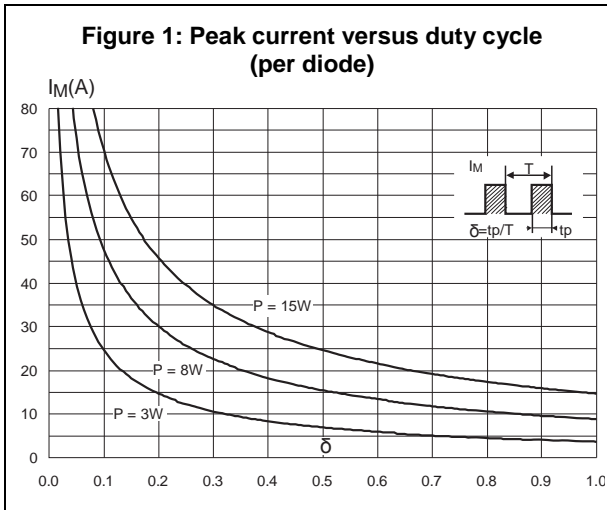

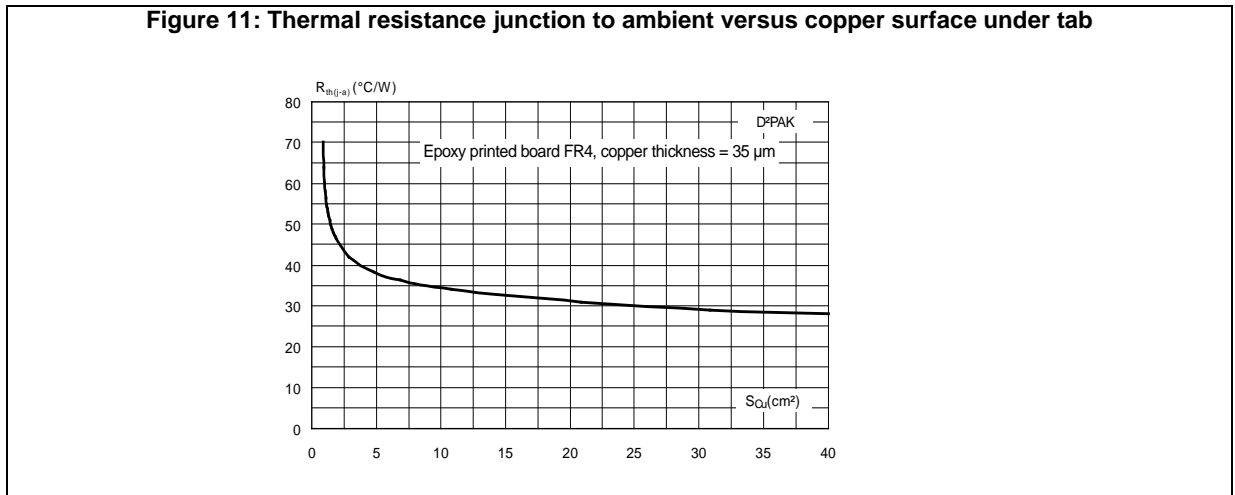
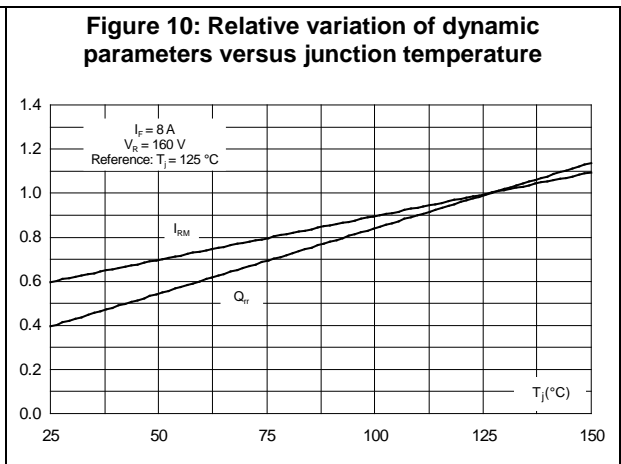
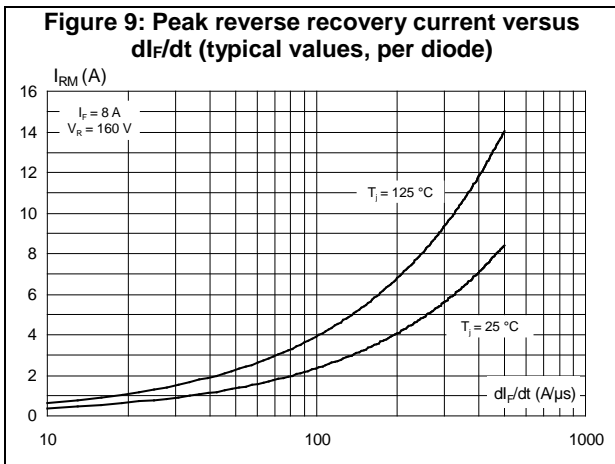
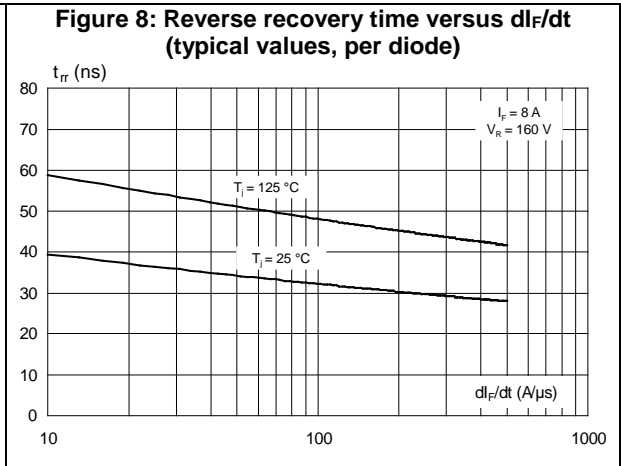
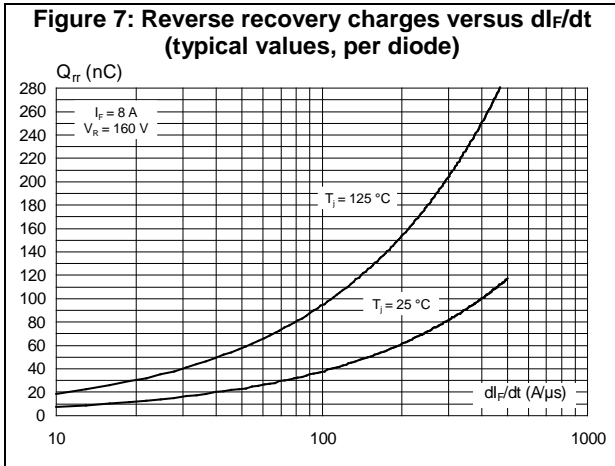

## 2 Package information

In order to meet environmental requirements, ST offers these devices in different grades of ECOPACK® packages, depending on their level of environmental compliance. ECOPACK® specifications, grade definitions and product status are available at: [www.st.com](http://www.st.com). ECOPACK® is an ST trademark.

- Cooling method: by conduction (C)
- Epoxy meets UL94,V0
- Recommended torque value (TO-220AB and TO-220FPAB): 0.55 N.m
- Maximum torque value (TO-220AB and TO-220FPAB): 0.70 N.m

2.1 D<sup>2</sup>PAK package information

Figure 12: D<sup>2</sup>PAK package outline

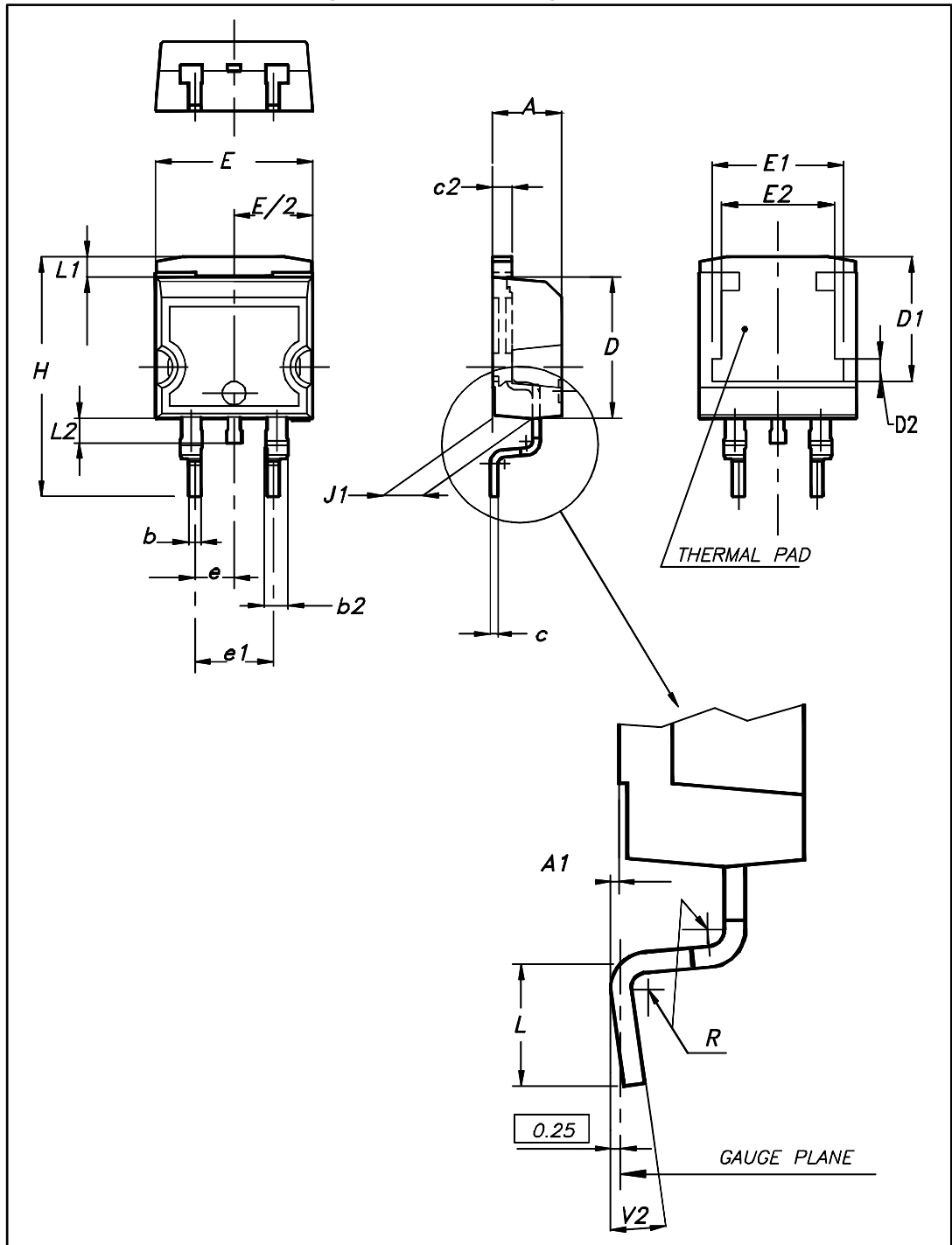

This package drawing may slightly differ from the physical package. However, all the specified dimensions are guaranteed.

Table 6: D<sup>2</sup>PAK package mechanical data

Ref.	Dimensions			
	Millimeters		Inches	
	Min.	Max.	Min.	Max.
A	4.36	4.60	0.172	0.181
A1	0.00	0.25	0.000	0.010
b	0.70	0.93	0.028	0.037
b2	1.14	1.70	0.045	0.067
c	0.38	0.69	0.015	0.027
c2	1.19	1.36	0.047	0.053
D	8.60	9.35	0.339	0.368
D1	6.90	8.00	0.272	0.311
D2	1.10	1.50	0.043	0.060
E	10.00	10.55	0.394	0.415
E1	8.10	8.90	0.319	0.346
E2	6.85	7.25	0.266	0.282
e	2.54 typ.		0.100	
e1	4.88	5.28	0.190	0.205
H	15.00	15.85	0.591	0.624
J1	2.49	2.90	0.097	0.112
L	1.90	2.79	0.075	0.110
L1	1.27	1.65	0.049	0.065
L2	1.30	1.78	0.050	0.070
R	0.4 typ.		0.015	
V2	0°	8°	0°	8°



Figure 13: D<sup>2</sup>PAK recommended footprint (dimensions in mm)

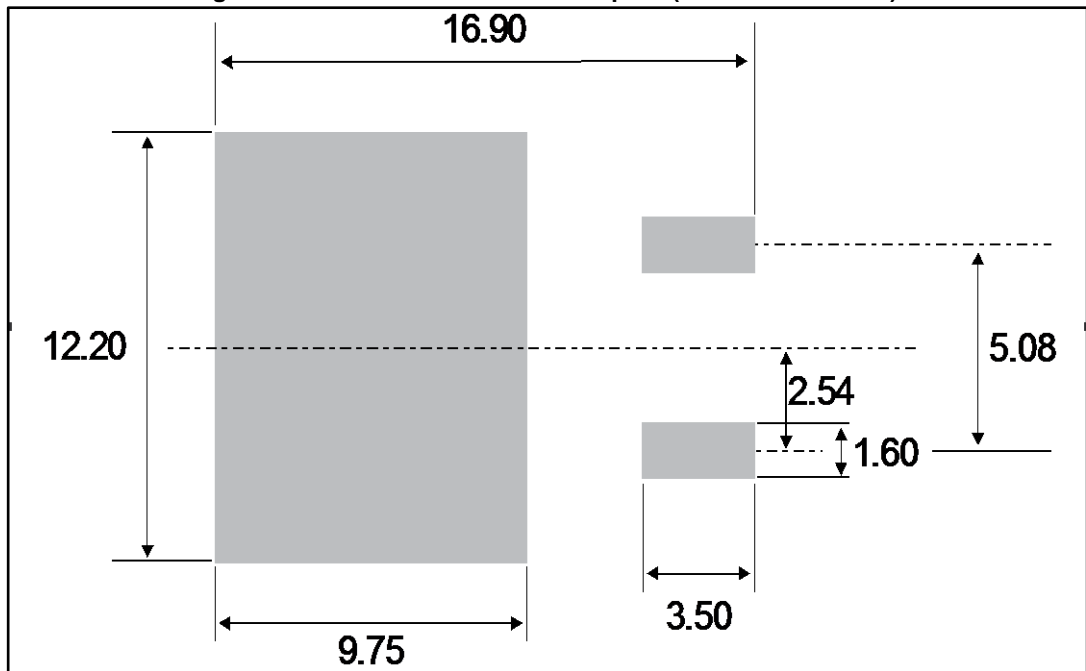

## 2.2 TO-220AB package information

Figure 14: TO-220AB package outline

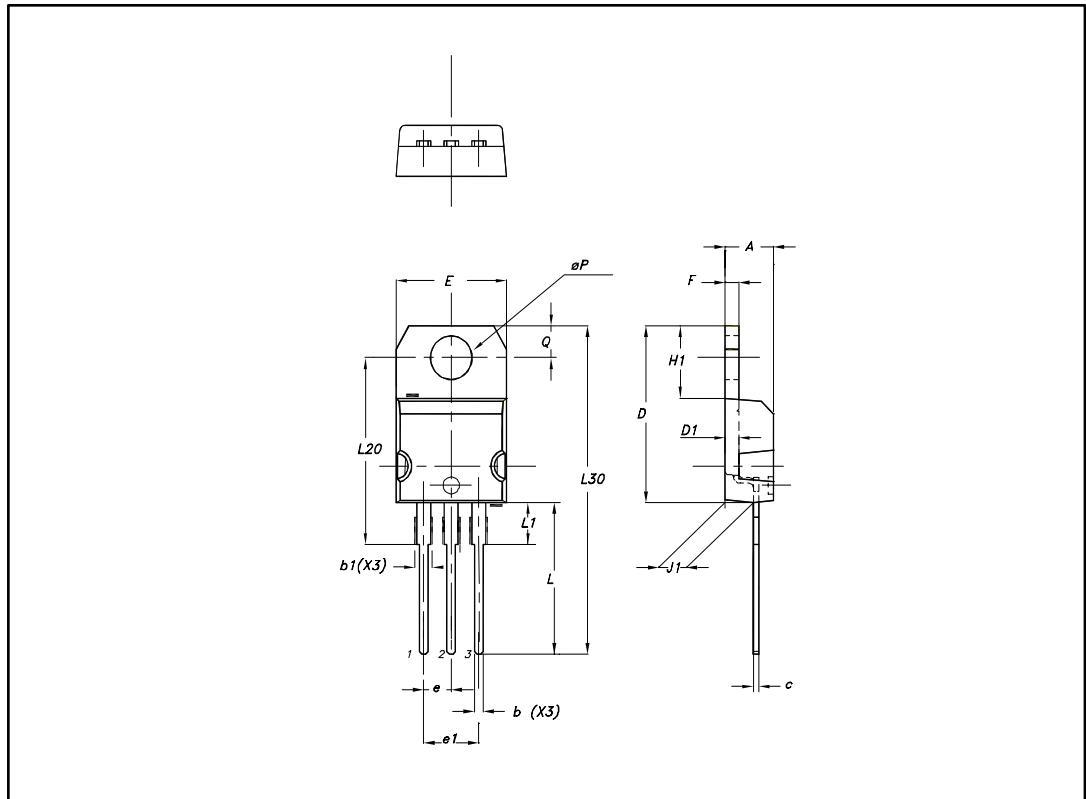

Table 7: TO-220AB package mechanical data

Ref.	Dimensions			
	Millimeters		Inches <sup>(1)</sup>	
	Min.	Max.	Min.	Max.
A	4.40	4.60	0.1732	0.1811
b	0.61	0.88	0.0240	0.0346
b1	1.14	1.70	0.0449	0.0669
c	0.48	0.70	0.0189	0.0276
D	15.25	15.75	0.6004	0.6201
D1	1.27 typ.		0.0500 typ.	
E	10.00	10.40	0.3937	0.4094
e	2.40	2.70	0.0945	0.1063
e1	4.95	5.15	0.1949	0.2028
F	1.23	1.32	0.0484	0.0520
H1	6.20	6.60	0.2441	0.2598
J1	2.40	2.72	0.0945	0.1071
L	13.00	14.00	0.5118	0.5512
L1	3.50	3.93	0.1378	0.1547
L20	16.40 typ.		0.6457 typ.	
L30	28.90 typ.		1.1378 typ.	
ØP	3.75	3.85	0.1476	0.1516
Q	2.65	2.95	0.1043	0.1161

**Notes:**

<sup>(1)</sup>Inch dimensions are for reference only.



Table 8: TO-220FPAB package mechanical data

Ref.	Dimensions			
	Millimeters		Inches (for reference only)	
	Min.	Max.	Min.	Max.
A	4.40	4.60	0.1739	0.1818
B	2.5	2.7	0.0988	0.1067
D	2.50	2.75	0.0988	0.1087
E	0.45	0.70	0.0178	0.0277
F	0.75	1.0	0.0296	0.0395
F1	1.15	1.70	0.0455	0.0672
F2	1.15	1.70	0.0455	0.0672
G	4.95	5.20	0.1957	0.2055
G1	2.40	2.70	0.0949	0.1067
H	10.00	10.40	0.3953	0.4111
L2	16.00 typ.		0.6324 typ.	
L3	28.60	30.60	1.1304	1.2095
L4	9.80	10.6	0.3874	0.4190
L5	2.90	3.60	0.1146	0.1423
L6	15.90	16.40	0.6285	0.6482
L7	9.00	9.30	0.3557	0.3676
Dia	3.0	3.20	0.1186	0.1265

### 3 Ordering information

Table 9: Ordering information

Order code	Marking	Package	Weight	Base qty.	Delivery mode
STTH1602CG-TR	STTH1602CG	D <sup>2</sup> PAK	1.38 g	1000	Tape and reel
STTH1602CT	STTH1602CT	TO-220AB	1.90 g	50	Tube
STTH1602CFP	STTH1602CFP	TO-220FPAB	1.70 g	50	Tube

### 4 Revision history

Table 10: Document revision history

Date	Revision	Changes
Feb-2004	1	First release
23-Apr-2014	2	Updated ECOPACK statement. Reformatted to current standards. Updated <i>Section 2: Package mechanical data</i>
11-Aug-2017	3	Updated features, package silhouette and <a href="#">Table 1: "Device summary"</a> . Updated <a href="#">Section 1: "Characteristics"</a> , <a href="#">Section 2: "Package information"</a> and <a href="#">Section 3: "Ordering information"</a> .

**IMPORTANT NOTICE – PLEASE READ CAREFULLY**

STMicroelectronics NV and its subsidiaries ("ST") reserve the right to make changes, corrections, enhancements, modifications, and improvements to ST products and/or to this document at any time without notice. Purchasers should obtain the latest relevant information on ST products before placing orders. ST products are sold pursuant to ST's terms and conditions of sale in place at the time of order acknowledgement.

Purchasers are solely responsible for the choice, selection, and use of ST products and ST assumes no liability for application assistance or the design of Purchasers' products.

No license, express or implied, to any intellectual property right is granted by ST herein.

Resale of ST products with provisions different from the information set forth herein shall void any warranty granted by ST for such product.

ST and the ST logo are trademarks of ST. All other product or service names are the property of their respective owners.

Information in this document supersedes and replaces information previously supplied in any prior versions of this document.

© 2017 STMicroelectronics – All rights reserved

# Mouser Electronics

Authorized Distributor

Click to View Pricing, Inventory, Delivery & Lifecycle Information:

[STMicroelectronics:](#)

[STTH1602CT](#) [STTH1602CFP](#) [STTH1602CG-TR](#)