



# STTH30R03CW/CG

## HIGH FREQUENCY SECONDARY RECTIFIER

### MAJOR PRODUCT CHARACTERISTICS

$I_{F(AV)}$	2 x 15 A
$V_{RRM}$	300 V
$I_{RM}$ (typ.)	4.5A
$T_j$ (max)	175 °C
$V_F$ (max)	1.4 V
$t_{rr}$ (max)	35 ns

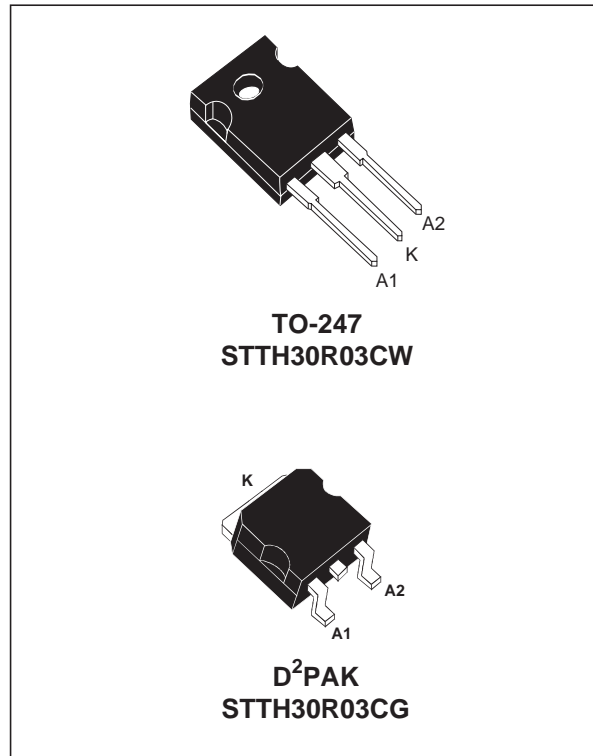
### FEATURES AND BENEFITS

- Designed for high frequency applications.
- Hyperfast recovery competes with GaAs devices.
- Allows size decrease of snubbers and heatsinks.

### DESCRIPTION

The TURBOSWITCH "R" is an ultra high performance diode.

This TURBOSWITCH family, which drastically cuts losses in associated MOSFET when run at high  $di_F/dt$ , is suited for HF OFF-Line SMPS and DC/DC converters.



### ABSOLUTE RATINGS (limiting values, per diode)

Symbol	Parameter		Value	Unit
$V_{RRM}$	Repetitive peak reverse voltage		300	V
$I_{F(RMS)}$	RMS forward current		30	A
$I_{F(AV)}$	Average forward current	$T_c = 120^\circ\text{C}$ $\delta = 0.5$	Per diode 15 Per device 30	A
$I_{FSM}$	Surge non repetitive forward current	$t_p = 10$ ms sinusoidal	120	A
$T_{stg}$	Storage temperature range		- 65 + 175	°C
$T_j$	Maximum operating junction temperature		+ 175	°C

**THERMAL AND POWER DATA**

Symbol	Parameter		Value	Unit
R <sub>th (j-c)</sub>	Junction to case	Per diode	2.0	°C/W
		Total	1.2	
R <sub>th (c)</sub>		Coupling	0.4	

**STATIC ELECTRICAL CHARACTERISTICS**

Symbol	Parameter	Tests conditions		Min.	Typ.	Max.	Unit
I <sub>R</sub> *	Reverse leakage current	V <sub>R</sub> = V <sub>RRM</sub>	T <sub>j</sub> = 25°C			20	μA
			T <sub>j</sub> = 125°C		30	200	
V <sub>F</sub> **	Forward voltage drop	I <sub>F</sub> = 15 A	T <sub>j</sub> = 25°C			1.9	V
			T <sub>j</sub> = 125°C		1.1	1.4	

Pulse test : \* t<sub>p</sub> = 5 ms, δ < 2 %

\*\* t<sub>p</sub> = 380 μs, δ < 2%

To evaluate the maximum conduction losses use the following equation :

$$P = 1 \times I_{F(AV)} + 0.026 I_{F(RMS)}^2$$

**RECOVERY CHARACTERISTICS**

Symbol	Tests conditions		Min.	Typ.	Max.	Unit
t <sub>rr</sub>	I <sub>F</sub> = 0.5 A   I <sub>rr</sub> = 0.25 A   I <sub>R</sub> = 1A	T <sub>j</sub> = 25°C		20		ns
	I <sub>F</sub> = 1 A   dI <sub>F</sub> /dt = - 50 A/μs   V <sub>R</sub> = 30V				35	
I <sub>RM</sub>	V <sub>R</sub> = 200 V   I <sub>F</sub> = 15A   dI <sub>F</sub> /dt = - 200A/μs	T <sub>j</sub> = 125°C		4.5	6	A
S factor				0.4		

**TURN-ON SWITCHING CHARACTERISTICS**

Symbol	Tests conditions	Min.	Typ.	Max.	Unit
t <sub>fr</sub>	T <sub>j</sub> = 25°C   I <sub>F</sub> = 15A   dI <sub>F</sub> /dt = 100A/μs measured at 1.1xV <sub>Fmax</sub>			300	ns
V <sub>FP</sub>	T <sub>j</sub> = 25°C   I <sub>F</sub> = 15A   dI <sub>F</sub> /dt = 100A/μs			3.5	V

Fig. 1: Conduction losses versus average current

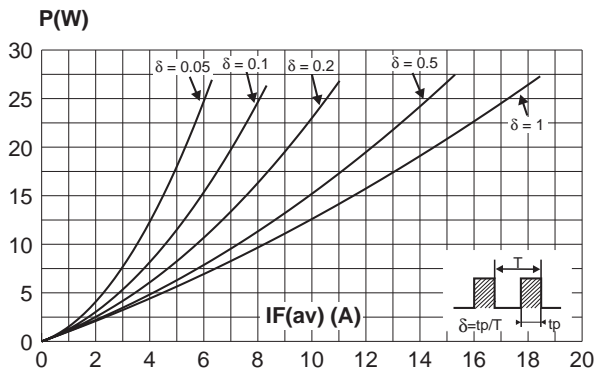


Fig. 2: Forward voltage drop versus forward current

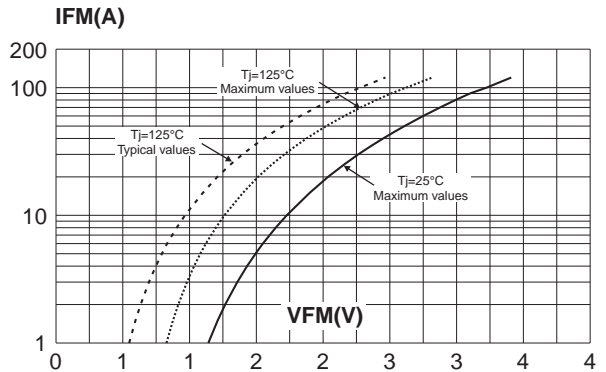


Fig. 3: Relative variation of thermal impedance junction to case versus pulse duration

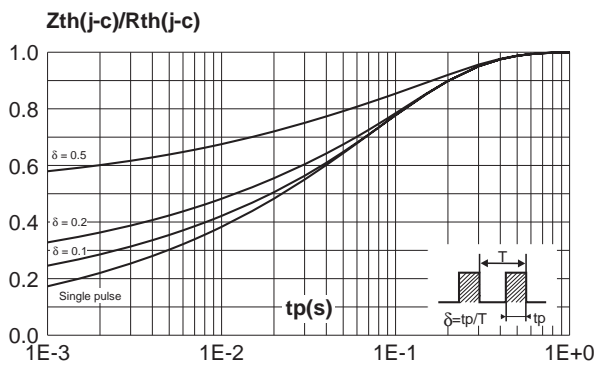


Fig. 4: Peak reverse recovery current versus dIF/dt (90% confidence)

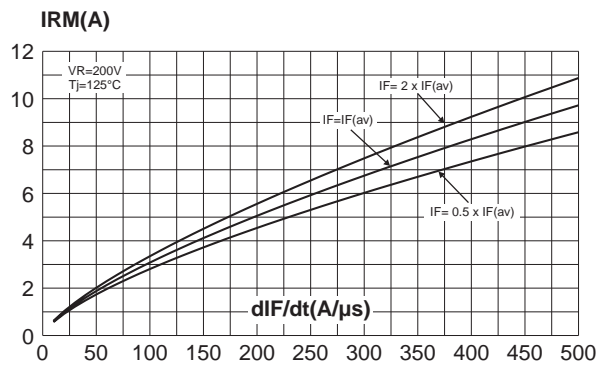


Fig. 5: Reverse recovery time versus dIF/dt (90% confidence)

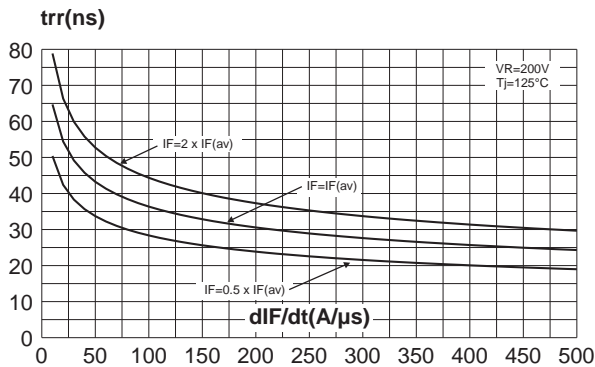
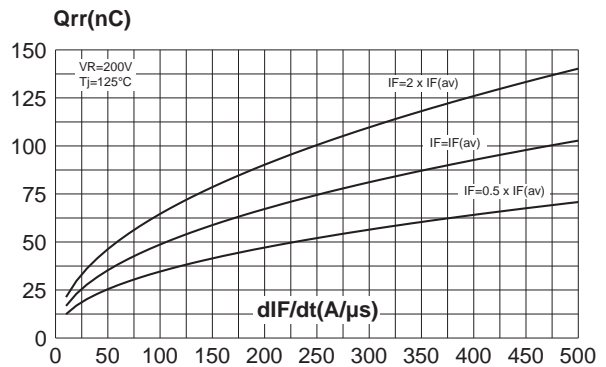
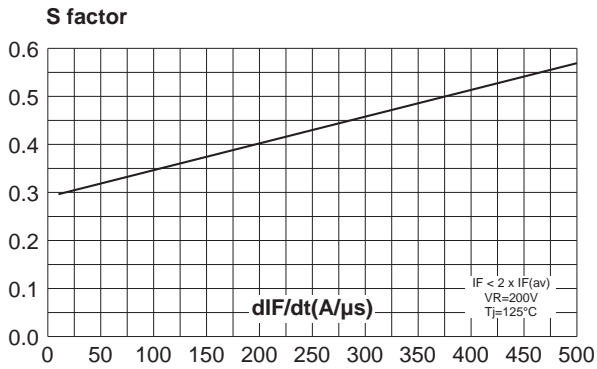


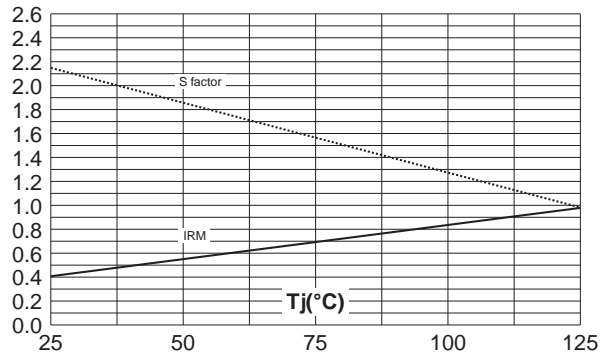
Fig. 6: Reverse recovery charges versus dIF/dt (90% confidence)



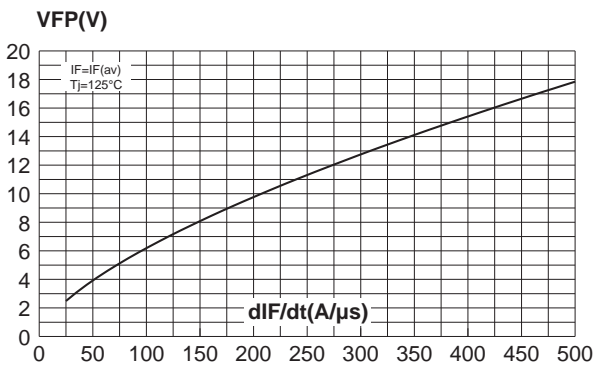
**Fig. 7:** Softness factor (tb/ta) versus dIF/dt (typical values).



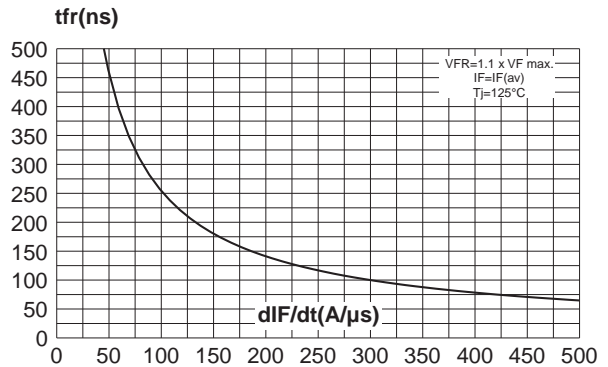
**Fig. 8:** Relative variation of dynamic parameters versus junction temperature (Reference: Tj=125°C).



**Fig. 9:** Transient peak forward voltage versus dIF/dt (90% confidence).

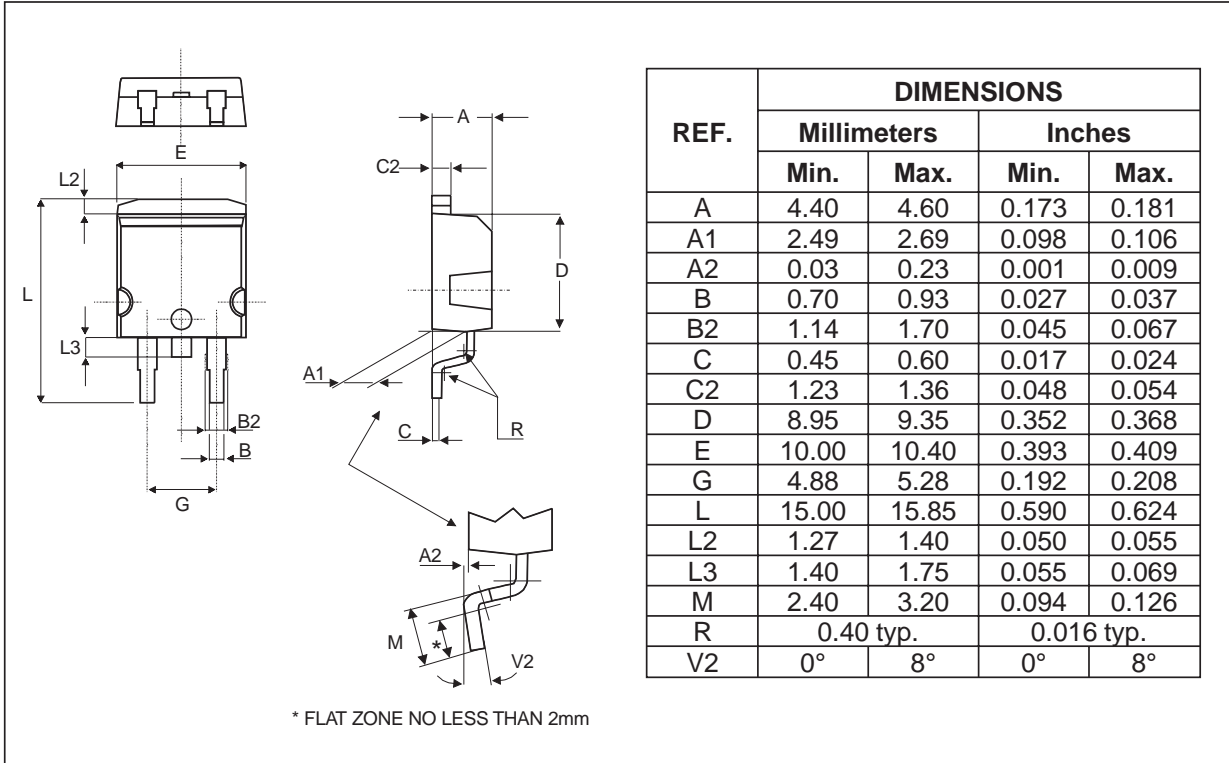


**Fig. 10:** Forward recovery time versus dIF/dt (90% confidence).

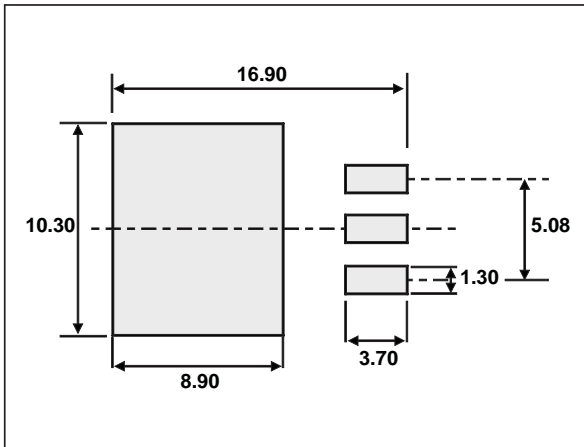


PACKAGE MECHANICAL DATA

D<sup>2</sup>PAK



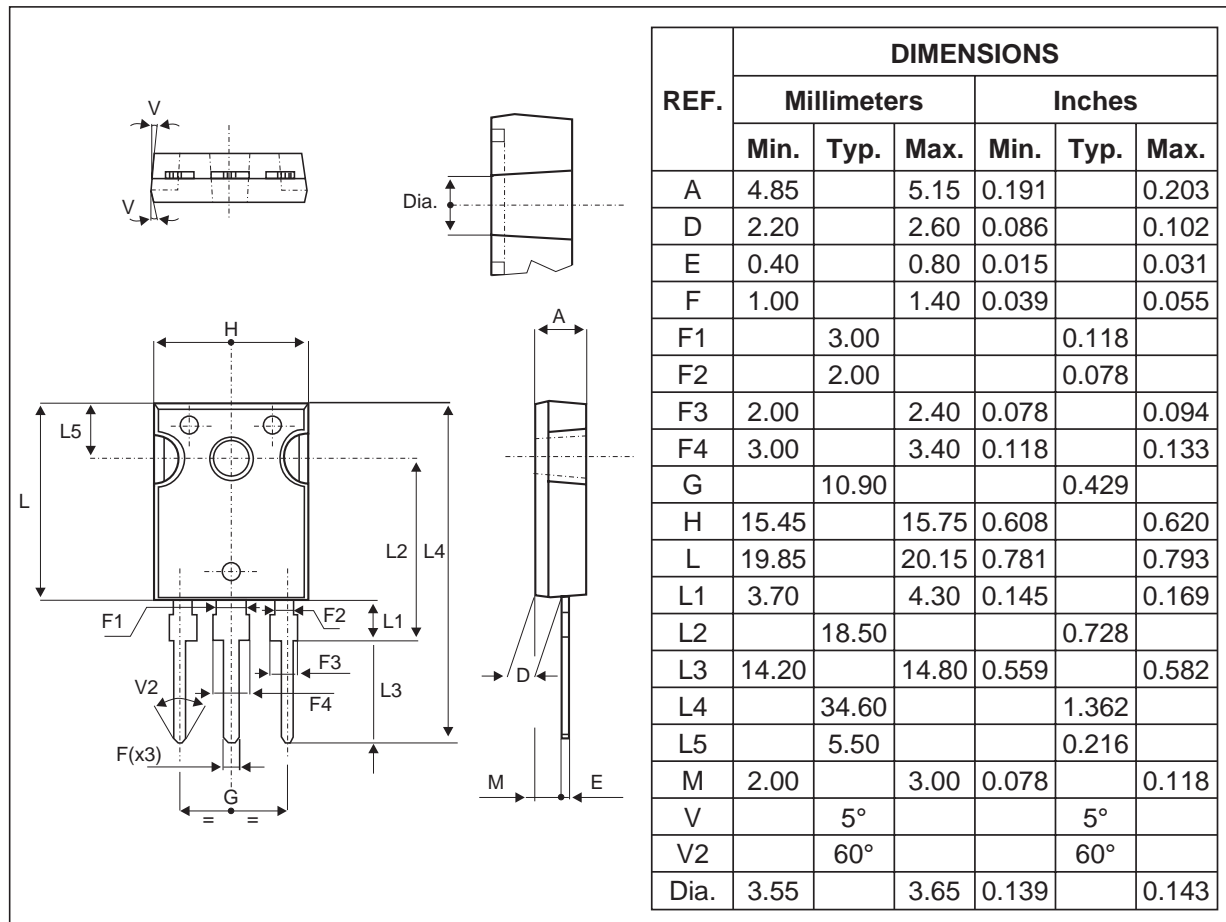
FOOTPRINT



# STTH30R03CW/CG

## PACKAGE MECHANICAL DATA

TO-247



Ordering code	Marking	Package	Weight	Base qty	Delivery mode
STTH30R03CW	STTH30R03CW	TO-247	4.36g	30	Tube
STTH30R03CG	STTH30R03CG	D <sup>2</sup> PAK	1.48g	50	Tube
STTH30R03CG-TR	STTH30R03CG	D <sup>2</sup> PAK	1.48g	1000	Tape & Reel

- Cooling method: by conduction (C)
- Recommended torque value: 0.8 N.m.
- Maximum torque value: 1 N.m.
- Epoxy meets UL 94,V0

Information furnished is believed to be accurate and reliable. However, STMicroelectronics assumes no responsibility for the consequences of use of such information nor for any infringement of patents or other rights of third parties which may result from its use. No license is granted by implication or otherwise under any patent or patent rights of STMicroelectronics. Specifications mentioned in this publication are subject to change without notice. This publication supersedes and replaces all information previously supplied. STMicroelectronics products are not authorized for use as critical components in life support devices or systems without express written approval of STMicroelectronics.

The ST logo is a registered trademark of STMicroelectronics

© 2002 STMicroelectronics - Printed in Italy - All rights reserved.

STMicroelectronics GROUP OF COMPANIES

Australia - Brazil - Canada - China - Finland - France - Germany  
 Hong Kong - India - Israel - Italy - Japan - Malaysia - Malta - Morocco - Singapore  
 Spain - Sweden - Switzerland - United Kingdom - United States.

<http://www.st.com>



# Mouser Electronics

Authorized Distributor

Click to View Pricing, Inventory, Delivery & Lifecycle Information:

[STMicroelectronics:](#)

[STTH30R03CW](#) [STTH30R03CG-TR](#)