

50 ohm nominal input / conjugate match balun to SPIRIT1 434 MHz, with integrated harmonic filter

Datasheet - production data

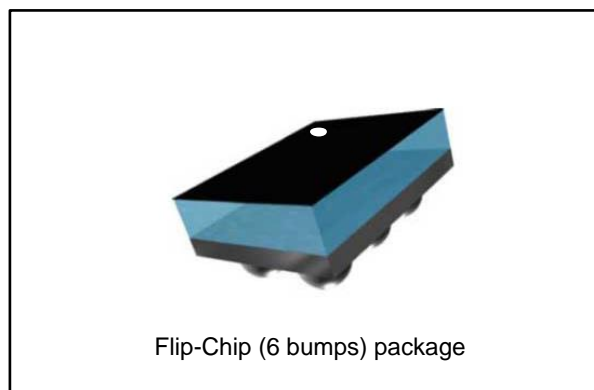

## Features

- 50  $\Omega$  nominal input / conjugate match to SPIRIT1
- Low insertion loss
- Low amplitude imbalance
- Low phase imbalance
- Small footprint

## Benefits

- Very low profile < 670  $\mu\text{m}$  after reflow
- High RF performance
- RF BOM and area reduction

## Applications

- 434 MHz impedance matched balun filter
- Optimized for ST chip set SPIRIT1

## Description

STMicroelectronics BALF-SPI-02D3 is an ultra miniature balun. The BALF-SPI-02D3 integrates matching network and harmonics filter. Matching impedance has been customized for the SPIRIT1 ST transceiver.

The BALF-SPI-02D3 uses STMicroelectronics IPD technology on non-conductive glass substrate which optimize RF performance.

Figure 1: Pin coordinates (top view)

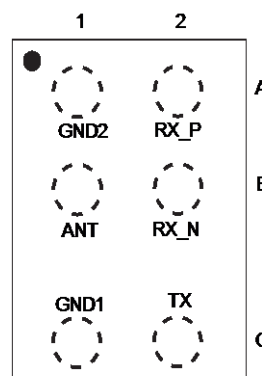

Figure 2: Application schematic (top view)

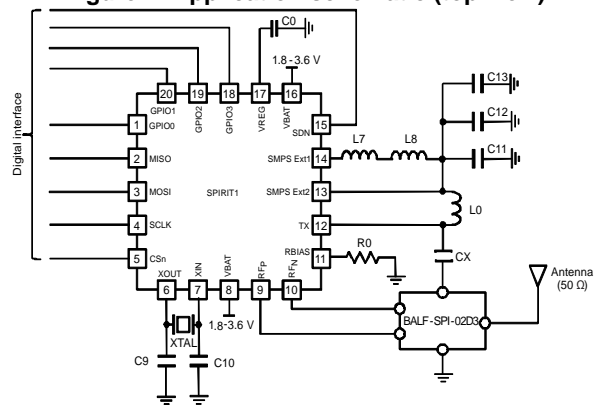

Table 1: Device summary

SMD	PN	Value
L0	LGQ15HSR15J02	150 nH
L7	LQM21FN100M70L	10 $\mu\text{H}$
L8	LQW15AN62NG00	62 nH
C11	GRM188R60J105KA01D	1 $\mu\text{F}$
C12	GRM155R71C104KA88D	100 nF
C13	GRM1555C1H331JA01D	330 pF
CX	GRM1555C1H221JA01	220 pF

# 1 Characteristics

**Table 2: Absolute ratings (limiting values)**

Symbol	Parameter	Value			Unit
		Min.	Typ.	Max.	
P <sub>IN</sub>	Input power RF <sub>IN</sub>		-	20	dBm
V <sub>ESD</sub>	ESD ratings MIL STD883C (HBM: C = 100 pF, R = 1.5 kΩ, air discharge)	2000	-		V
	ESD ratings machine model (MM: C = 200 pF, R = 25 Ω, L = 500 nH)	200	-		
T <sub>OP</sub>	Operating temperature	-40	-	+85	°C

**Table 3: Impedances (T<sub>amb</sub> = 25 °C)**

Symbol	Parameter	Value			Unit
		Min.	Typ.	Max.	
Z <sub>RX</sub>	Nominal differential RX balun impedance	-	matched SPIRIT1	-	Ω
Z <sub>TX</sub>	Nominal TX filter impedance				
Z <sub>ANT</sub>	Antenna impedance	-	50	-	Ω

**Table 4: RF performances (T<sub>amb</sub> = 25 °C)**

Symbol	Parameter	Test condition	Value			Unit
			Min.	Typ.	Max.	
F	Frequency range (bandwidth)			434		MHz
S <sub>21RX-ANT</sub>	Insertion loss in bandwidth without mismatch loss (RX balun)			-2.3	-3.2	dB
S <sub>21TX-ANT</sub>	Insertion loss in bandwidth without mismatch loss (TX filter)			-2.4	-3.2	dB
S <sub>11ANT</sub>	Input return loss in bandwidth (RX balun)			-20	-10.5	dB
S <sub>11ANT</sub>	Input return loss in bandwidth (TX filter)			-32	-11	dB
φ <sub>imb</sub>	Output phase imbalance (RX balun)		-30	10	30	°
A <sub>imb</sub>	Output amplitude imbalance (RX balun)		-3.5	-1	2	dB
Att	Harmonic levels (TX filter)	Attenuation at 2fo	-40	-44		dBm
		Attenuation at 2fo	-40	-45		

### 1.1 RF measurements (Rx balun)

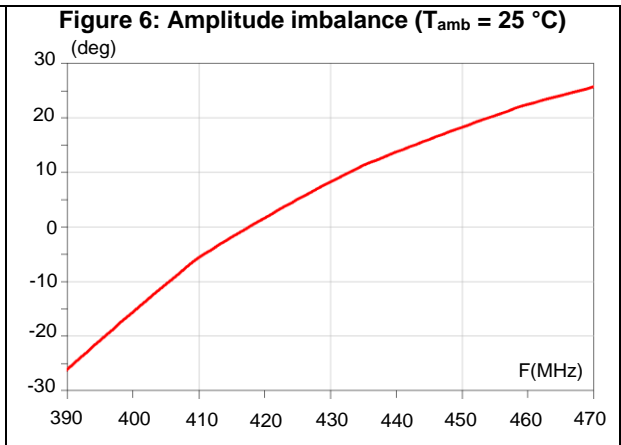
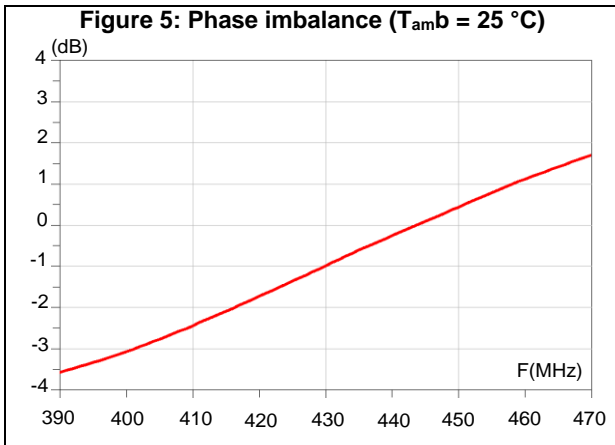
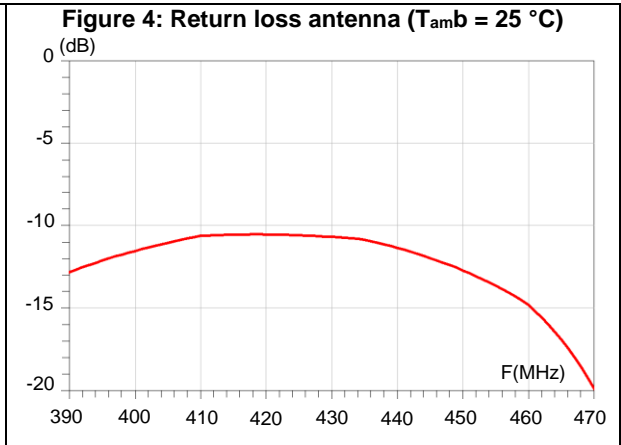
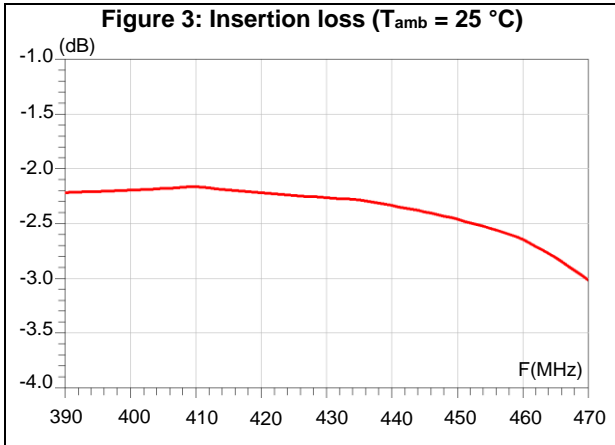

### 1.2 RF measurements (Tx filter)

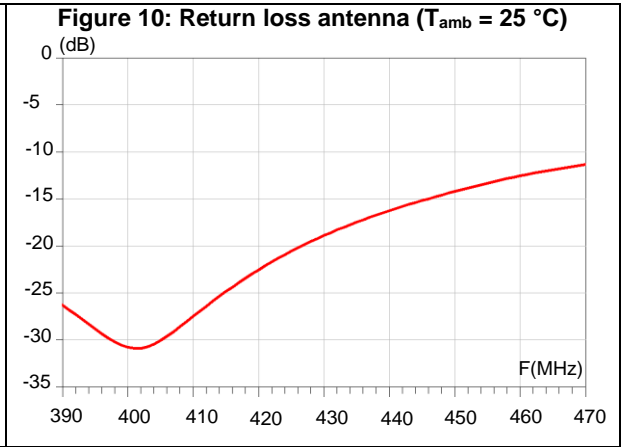
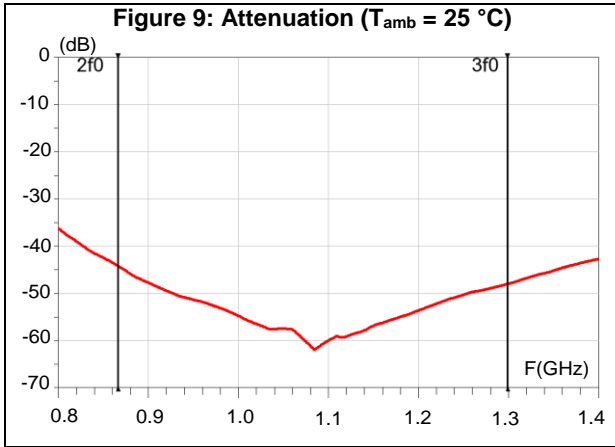
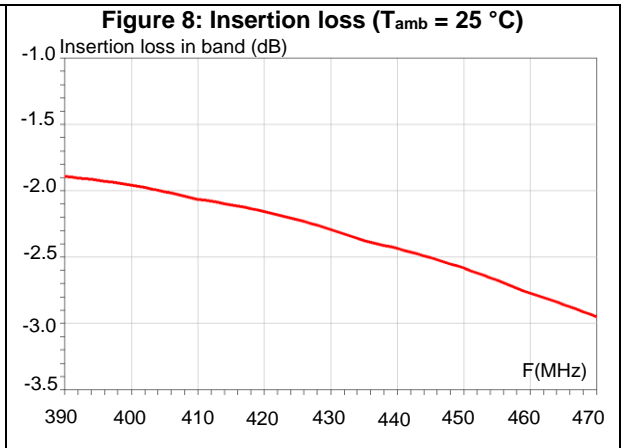
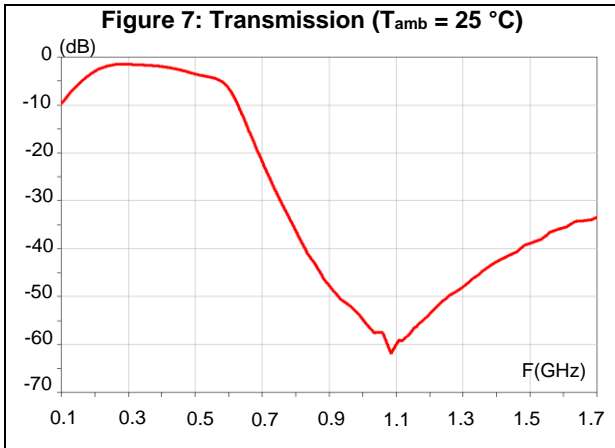

## 2 Application information

Figure 11: Application board EVB (4 layers)

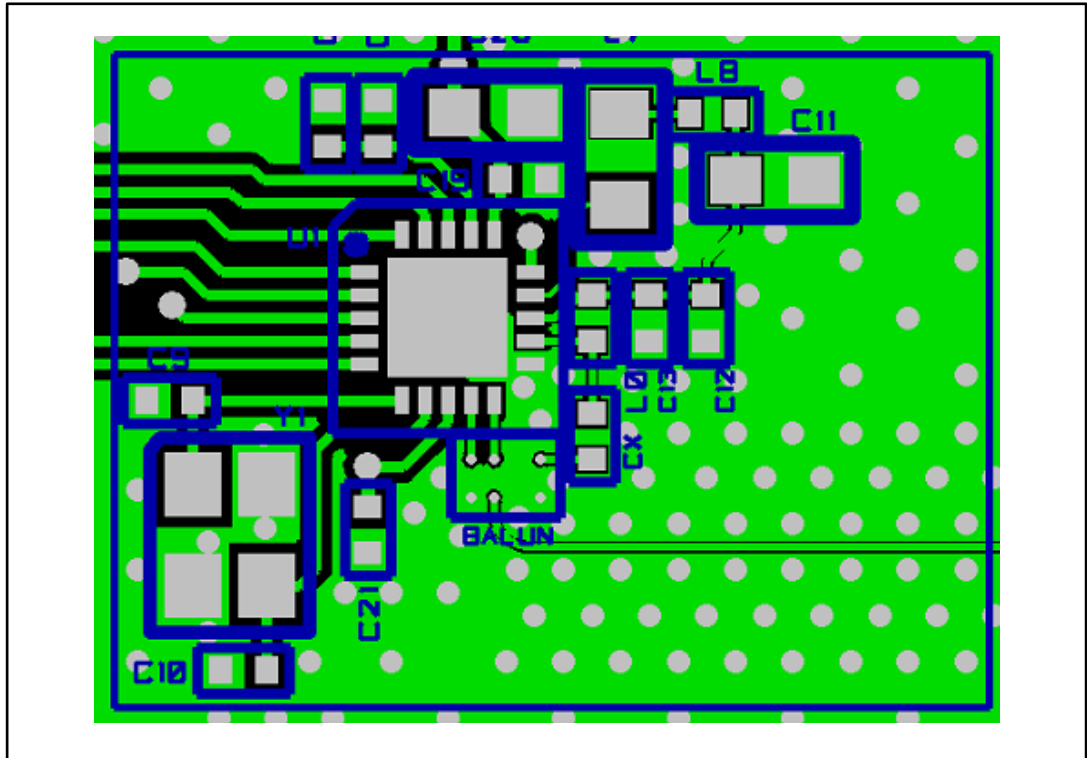

Figure 12: TX output measurements at 433 MHz (LQW15 62nH)

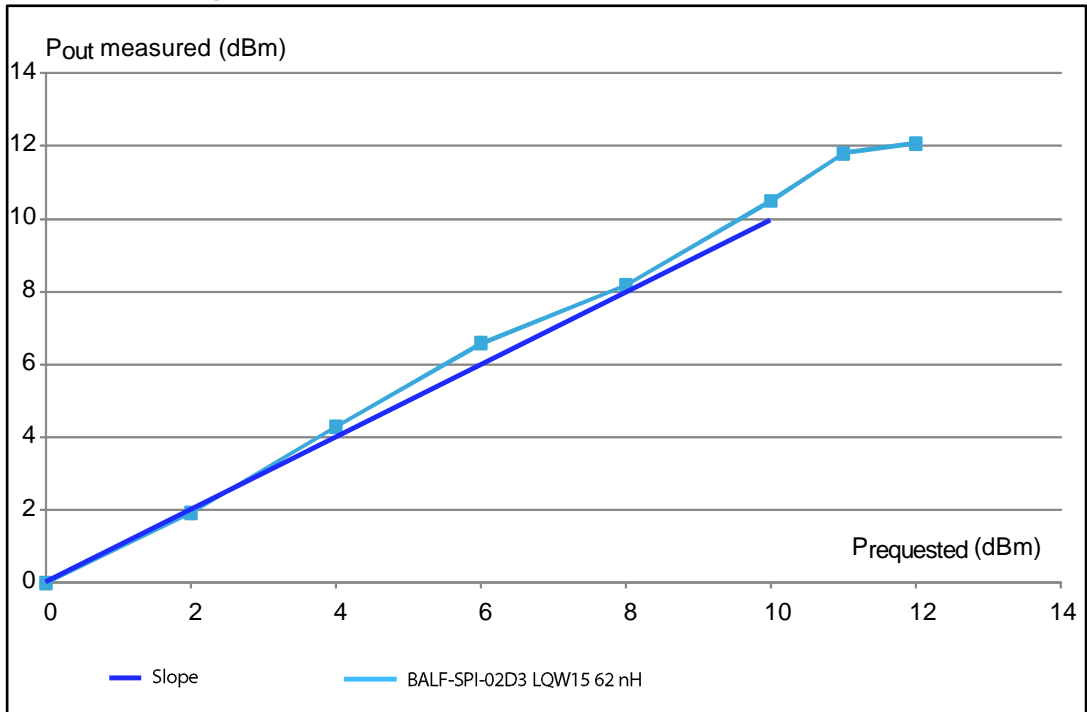
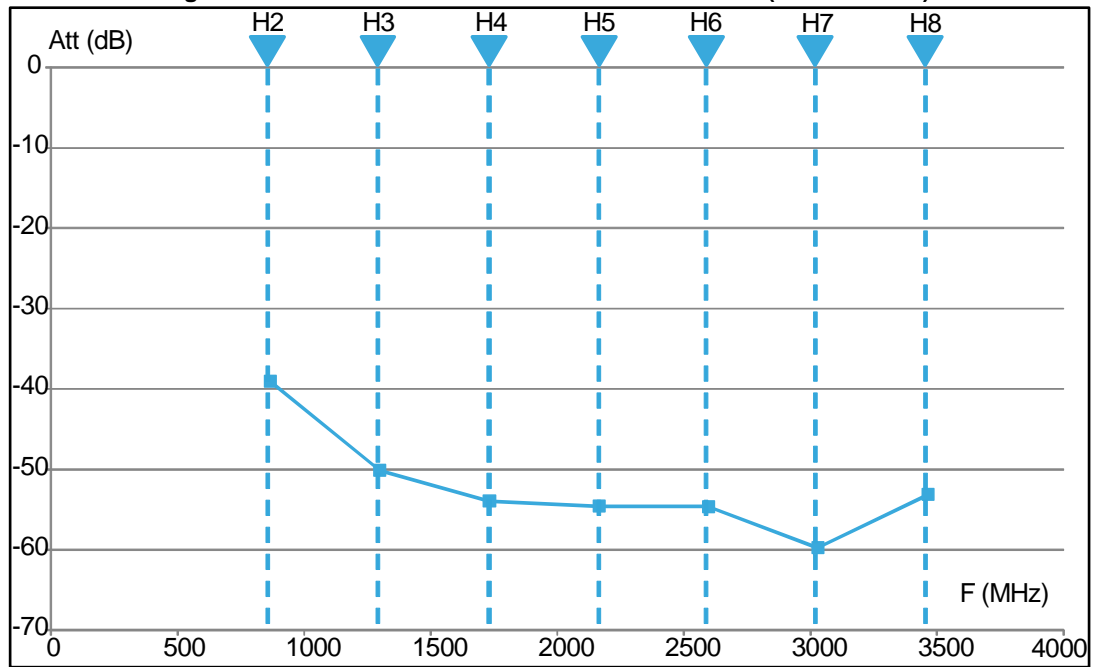

Figure 13: Harmonic measurements at  $P_{out} = 10\text{ dBm}$  (LQW15 62nH)



### 3 Package information

In order to meet environmental requirements, ST offers these devices in different grades of ECOPACK® packages, depending on their level of environmental compliance. ECOPACK® specifications, grade definitions and product status are available at: [www.st.com](http://www.st.com). ECOPACK® is an ST trademark.

- Epoxy meets UL94, V0
- Lead-free package

#### 3.1 Flip-Chip 6 bumps package information

Figure 14: Flip-Chip 6 bumps package outline (top and side view)

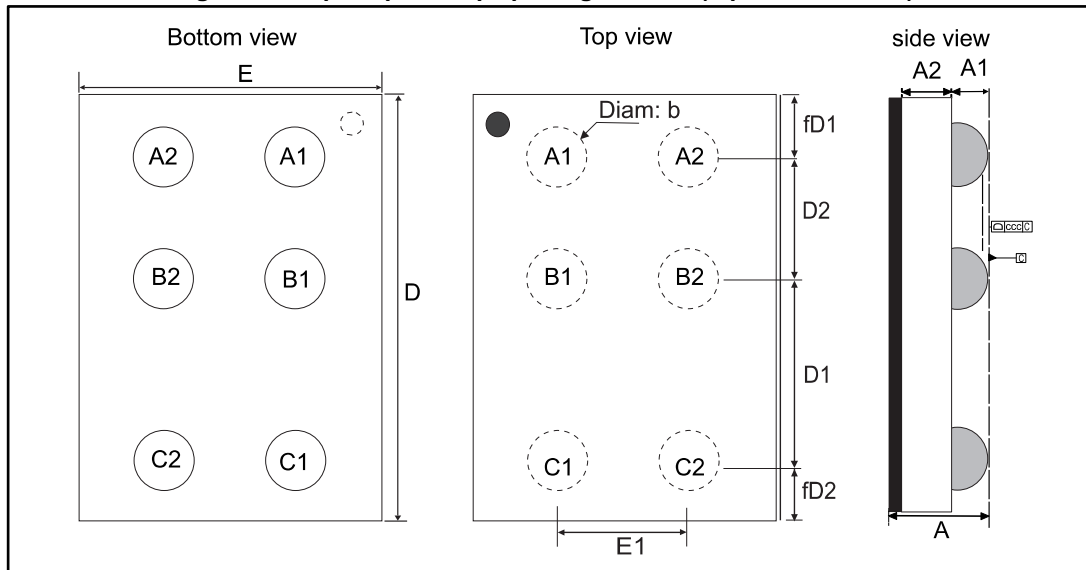
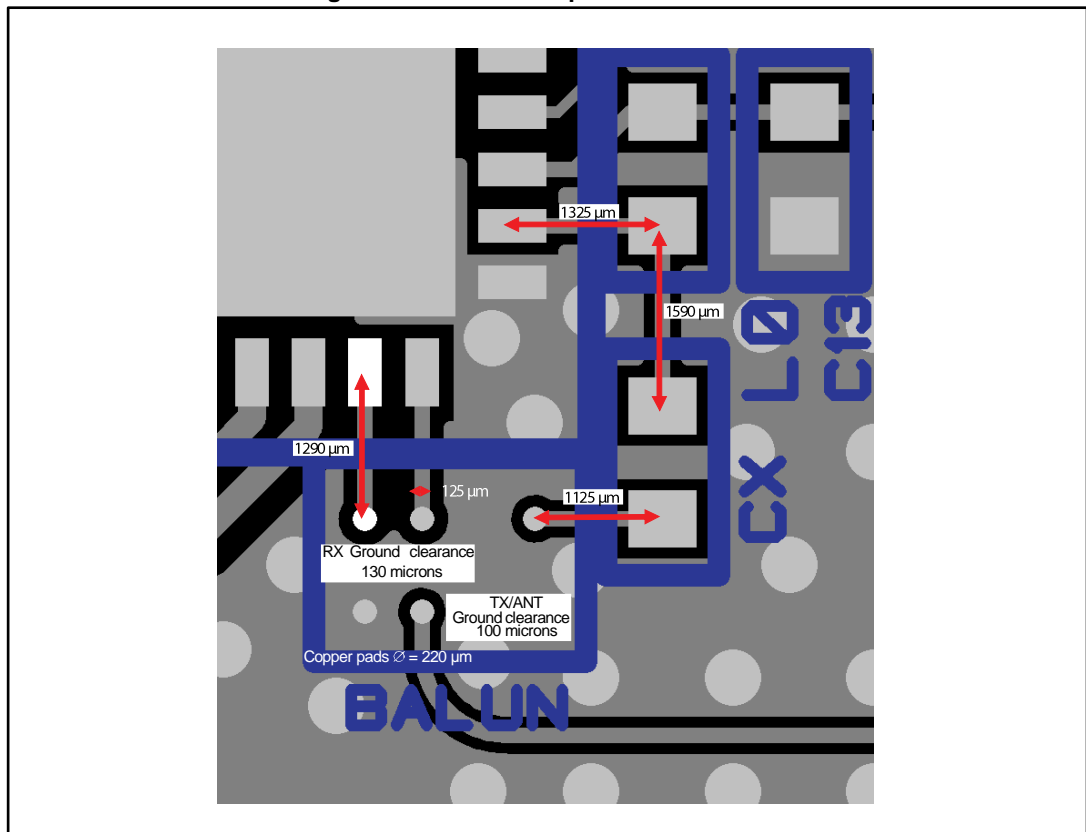

Table 5: Flip-Chip 6 bumps dimensions

Parameter	Description	Min.	Typ.	Max.	Unit
A	Bump height + substrate thickness	0.590	0.650	0.710	mm
A1	Bump height		0.200		mm
A2	Substrate thickness		0.400		mm
b	Bump diameter	0.210	0.250	0.290	mm
D	Y dimension of the die	1.950	2.000	2.050	mm
D1	Y pitch	0.960	1.000	1.040	mm
D2	Y pitch2	0.460	0.500	0.540	mm
E	X dimension of the die	1.350	1.400	1.450	mm
E1	X pitch	0.790	0.820	0.850	mm
fD1	Distance from bump to edge of die on Y axis		0.295		mm
fD2	Distance from bump to edge of die on Y axis		0.195		mm
ccc				005	mm

Figure 15: PCB stack-up recommendation





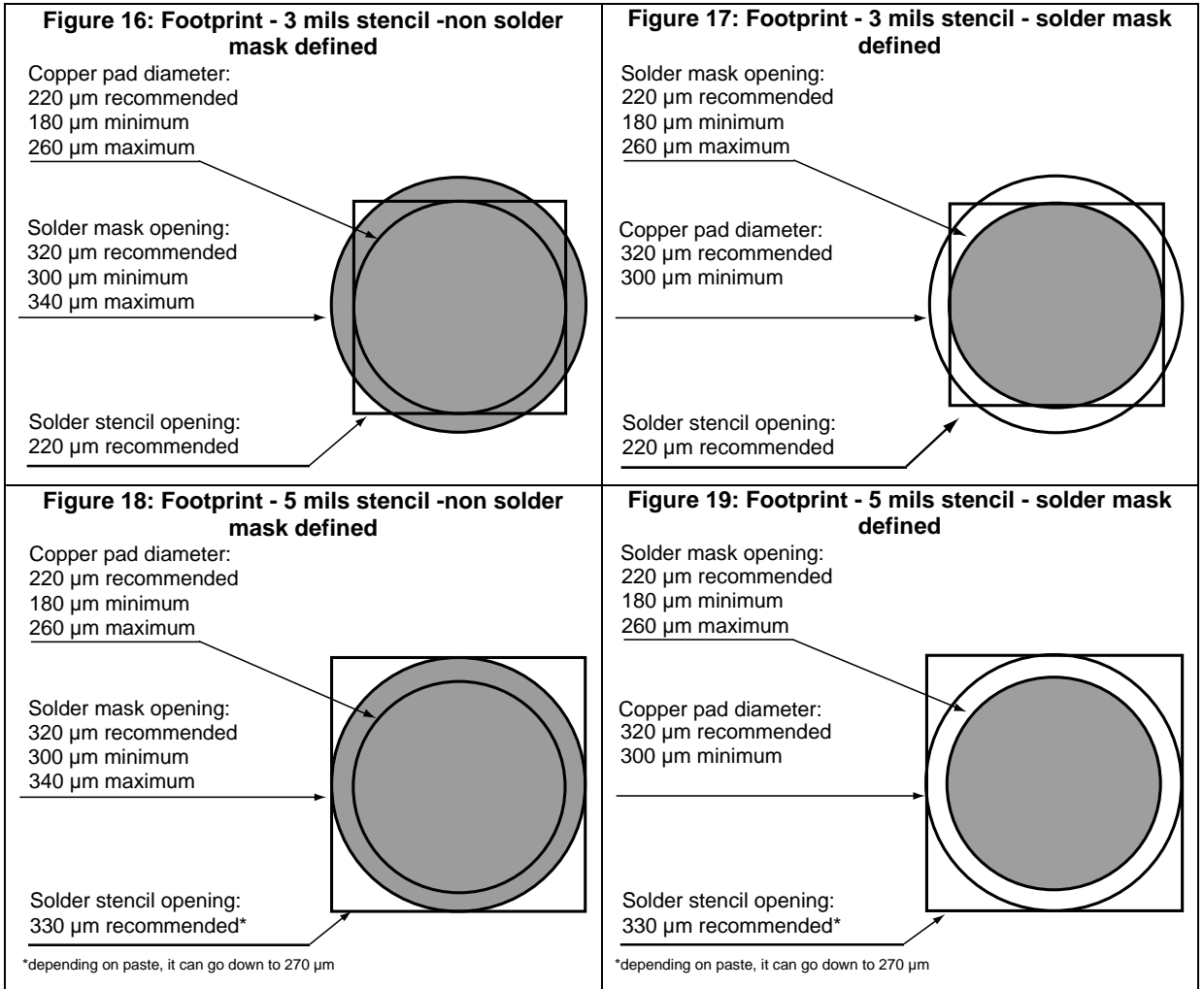

### 3.2 Flip-chip 6 bumps packing information

Figure 20: Marking

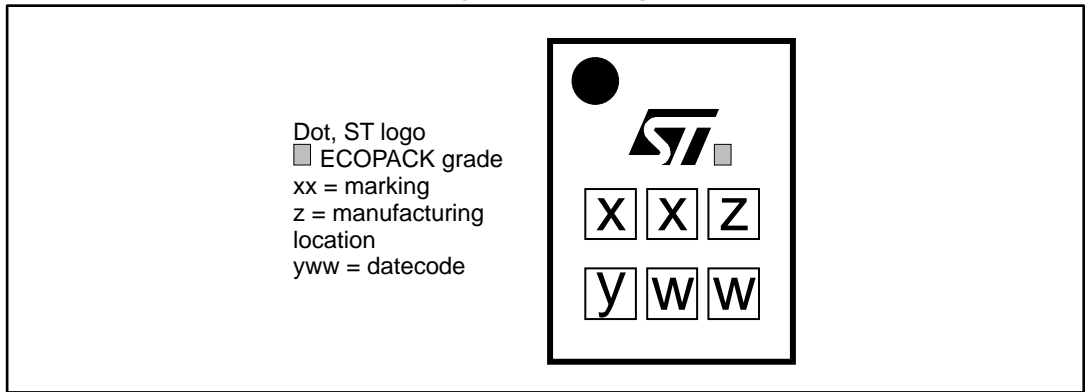
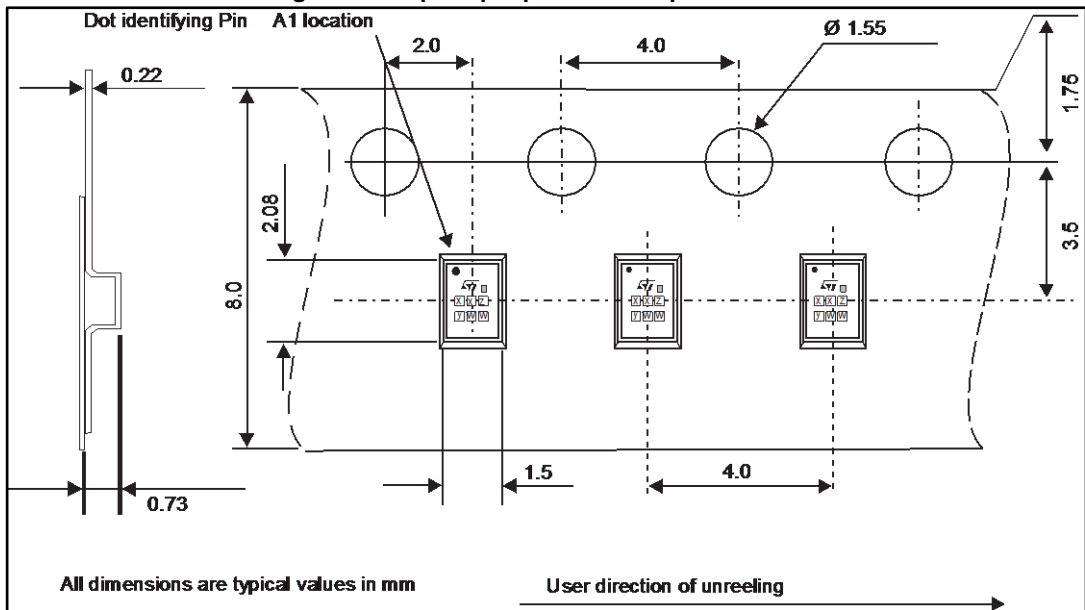

Figure 21: Flip Chip tape and reel specifications



More packing information is available in the application note:

- AN2348 Flip-Chip: "Package description and recommendations for use"

## 4 Ordering information

Table 6: Ordering information

Order code	Marking	Package	Weight	Base qty.	Delivery mode
BALF-SPI-02D3	TD	Flip-Chip 6 bumps	3.0 mg	5000	Tape and reel

## 5 Revision history

Table 7: Document revision history

Date	Revision	Changes
13-Jan-2015	1	Initial release.
15-May-2015	2	Updated Table 4. Added Figure 12, Figure 13, Figure 18 and Figure 19.
18-Sep-2015	3	Updated Figure 14 and added Figure 5.
22-Mar-2017	4	Updated <a href="#">Figure 14: "Flip-Chip 6 bumps package outline (top and side view)"</a> .

**IMPORTANT NOTICE – PLEASE READ CAREFULLY**

STMicroelectronics NV and its subsidiaries ("ST") reserve the right to make changes, corrections, enhancements, modifications, and improvements to ST products and/or to this document at any time without notice. Purchasers should obtain the latest relevant information on ST products before placing orders. ST products are sold pursuant to ST's terms and conditions of sale in place at the time of order acknowledgement.

Purchasers are solely responsible for the choice, selection, and use of ST products and ST assumes no liability for application assistance or the design of Purchasers' products.

No license, express or implied, to any intellectual property right is granted by ST herein.

Resale of ST products with provisions different from the information set forth herein shall void any warranty granted by ST for such product.

ST and the ST logo are trademarks of ST. All other product or service names are the property of their respective owners.

Information in this document supersedes and replaces information previously supplied in any prior versions of this document.

© 2017 STMicroelectronics – All rights reserved

# Mouser Electronics

Authorized Distributor

Click to View Pricing, Inventory, Delivery & Lifecycle Information:

[STMicroelectronics:](#)

[BALF-SPI-02D3](#)