

50 Ω nominal input / conjugate match balun to nRF51422-QFAA, nRF24LE1, nRF51822-QFAA/AB, with integrated harmonic filter

Datasheet - production data

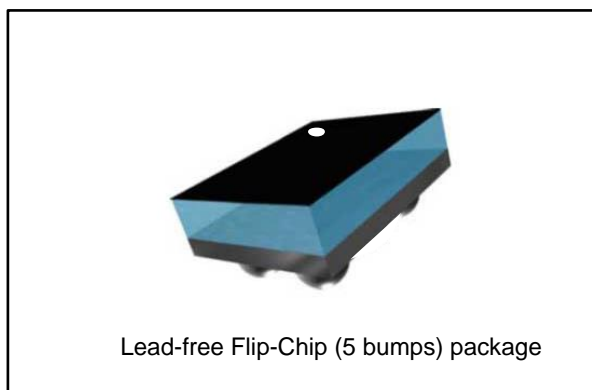

Description

STMicroelectronics BAL-NRF01D3 is an ultraminiature balun. The device integrates matching network and harmonics filter. Matching impedance has been customized for the following Nordic Semiconductor circuits: nRF24LE1 QFN-32 pins, nRF24AP2-1CH, nRF24AP2-8CH, nRF51422-QFAA (build code CA/C0), nRF51822-QFAA (build code CA/C0) and nRF51822-QFAB (build code AA/A0).

The device uses STMicroelectronics' IPD technology on a non-conductive glass substrate to optimize RF performance.

The BAL-NRF01D3 has been tested and approved by Nordic Semiconductor in their nRF2723 and nRF2752 nRFgo modules.

Features

- 50 Ω nominal input / conjugate match to Nordic Semiconductor chips nRF24LE1 QFN32, nRF24AP2-1CH, nRF24AP2-8CH, nRF51422-QFAA (build code CA/C0), nRF51822-QFAA (build code CA/C0) and nRF51822-QFAB (build code AA/A0)
- Low insertion loss
- Low amplitude imbalance
- Low phase imbalance
- Small footprint < 1.5 mm²

Benefits

- Very low profile < 595 μ m after reflow
- High RF performance
- RF BOM and area reduction

Applications

- 2.45 GHz impedance matched balun filter
- Optimized for Nordic's chip set nRF24LE1/AP2, nRF51422-QFAA (build code CA/C0), nRF51822-QFAA (build code CA/C0) and nRF51822-QFAB (build code AA/A0)

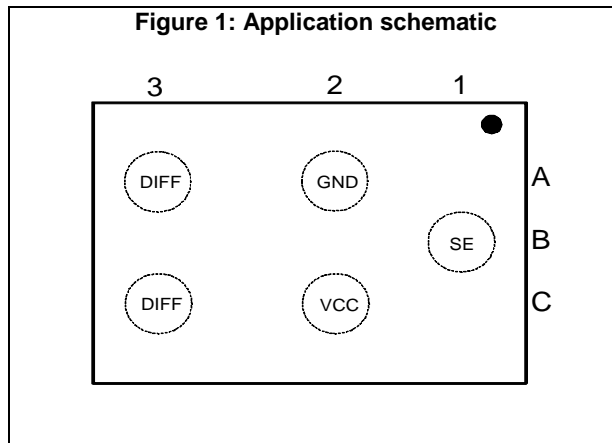

1 Characteristics

Table 1: Absolute maximum ratings (limiting values)

Symbol	Parameter	Value			Unit
		Min.	Typ.	Max.	
P _{IN}	Input power RFIN		-	20	dBm
V _{ESD}	ESD ratings MIL STD883C (HBM: C = 100 pF, R = 1.5 Ω, air discharge)	2000	-		V
	ESD ratings charge device model (JESD22-C101-C)	500			
	ESD ratings machine model (MM: C = 200 pF, R = 25 W, L = 500 nH)	200	-		
T _{OP}	Operating temperature	-40	-	+105	°C

Table 2: Impedances (T_{amb} = 25 °C)

Symbol	Parameter	Value			Unit
		Min.	Typ.	Max.	
Z _{OUT}	Nominal differential output impedance	-	Conjugate match to: nRF24LE1/AP2 nRF51422-QFAA (build code CA/C0) nRF51822-QFAA (build code CA/C0) nRF51822-QFAB (build code AA/A0)	-	Ω
Z _{IN}	Nominal input impedance	-	50	-	Ω

Table 3: RF performance (T_{amb} = 25 °C)

Symbol	Parameter	Test condition	Value			Unit
			Min.	Typ.	Max.	
F	Frequency range (bandwidth)	2400 2540	2400		2540	MHz
I _L	Insertion loss in bandwidth			2.25		dB
R _L	Return loss in bandwidth			10		dB
φ _{imb}	Phase imbalance			3		°
A _{imb}	Amplitude imbalance			0.1		dB
2f ₀	2nd harmonic filtering	4880 MHz		10		dB
3f ₀	3rd harmonic filtering	7320 MHz		20		dB

1.1 RF measurement

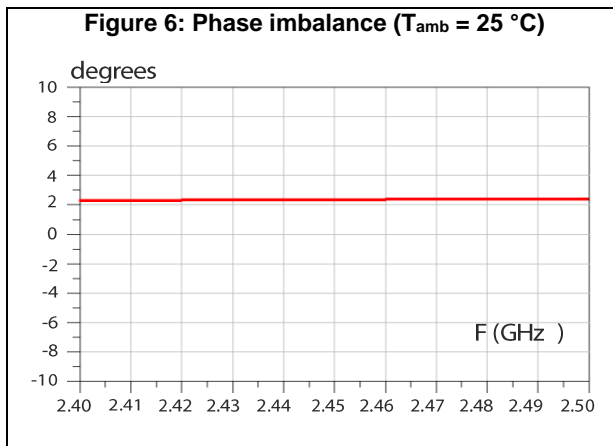
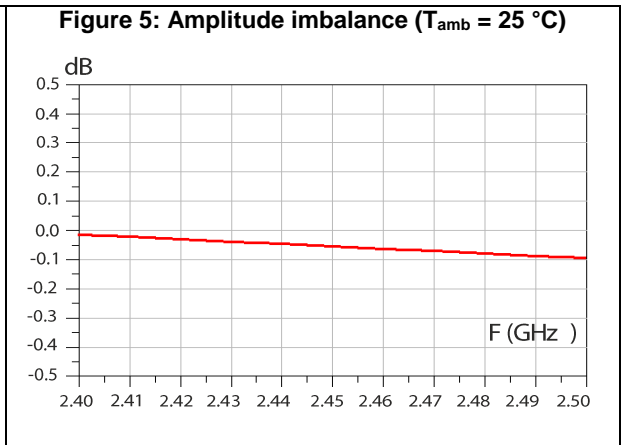
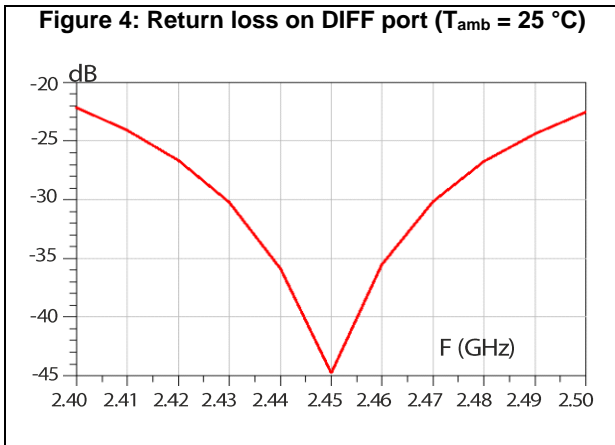
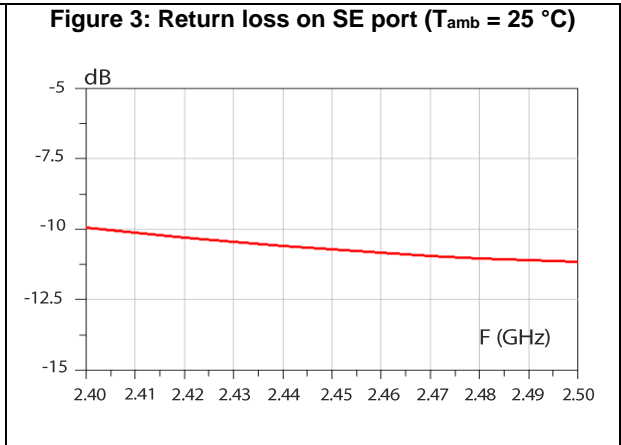
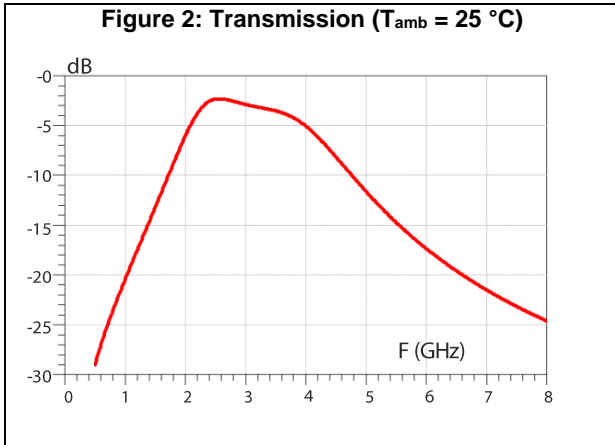

2 Application information

Figure 7: Application schematic (courtesy of Nordic Semiconductor)

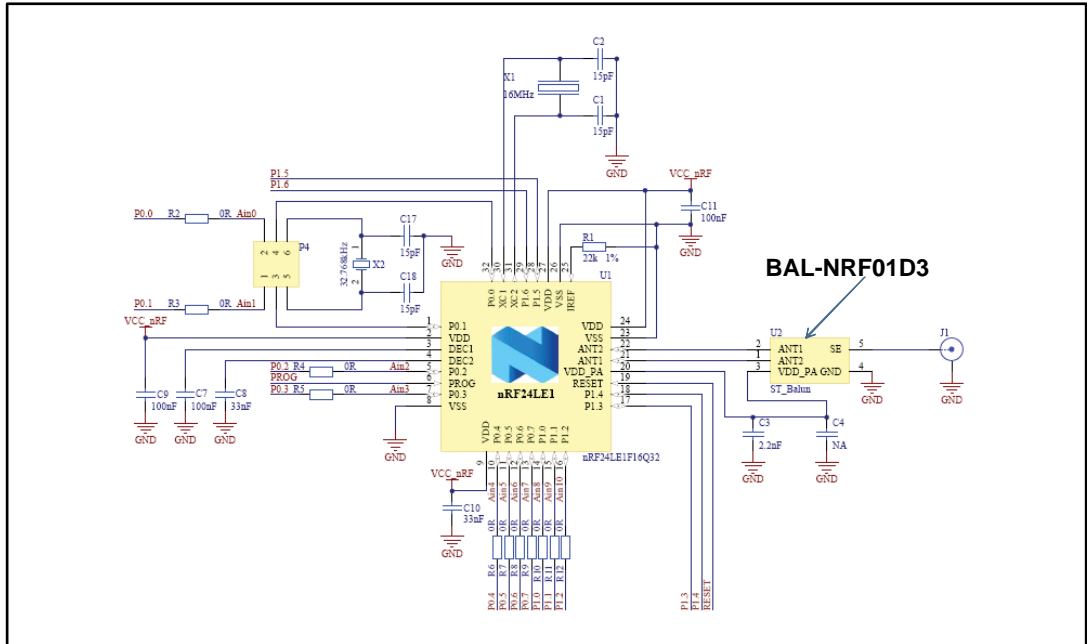

Figure 8: nRF2723 application board (courtesy of Nordic Semiconductor)

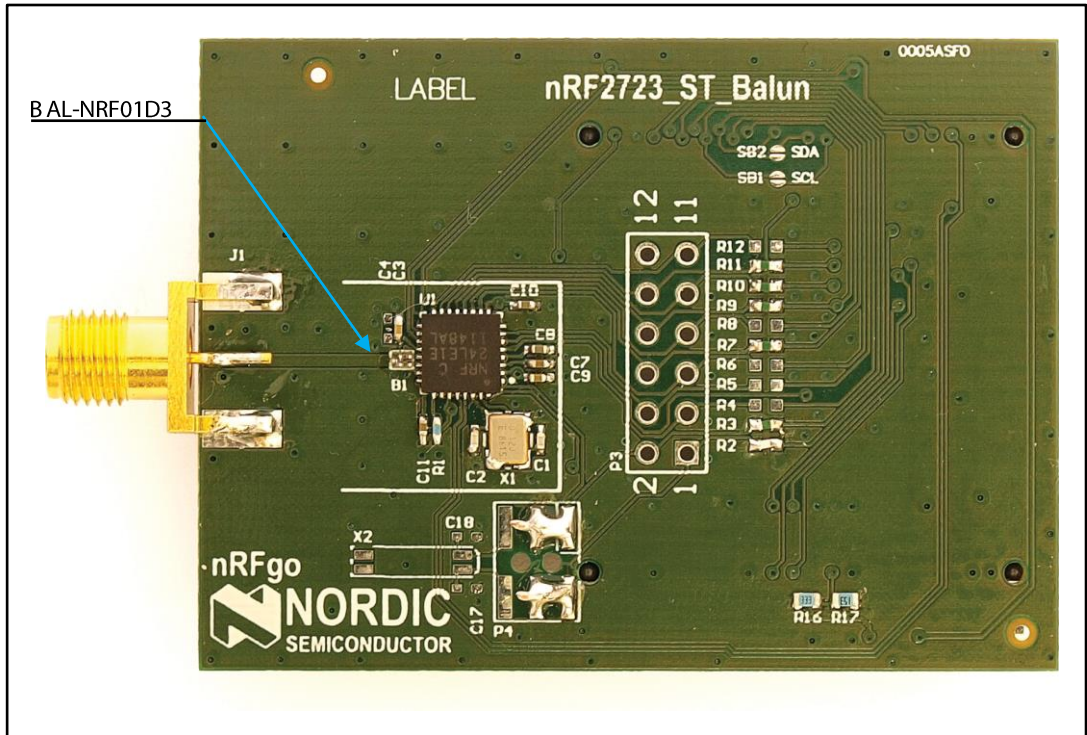
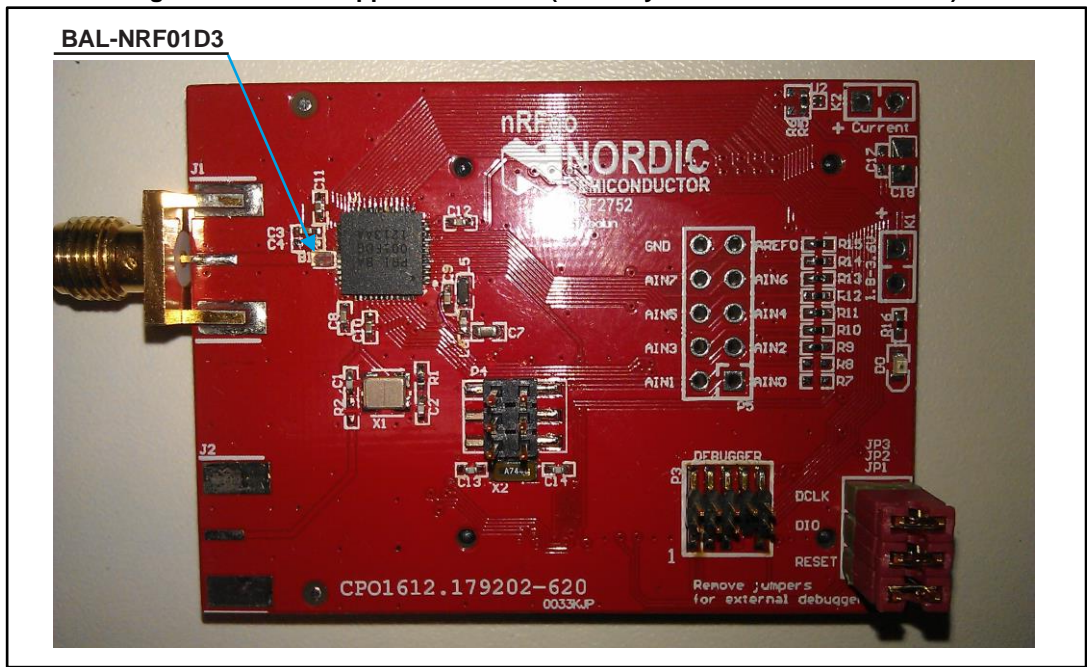

Figure 9: nRF2752 application board (courtesy of Nordic Semiconductor)



3 Package information

In order to meet environmental requirements, ST offers these devices in different grades of ECOPACK® packages, depending on their level of environmental compliance. ECOPACK® specifications, grade definitions and product status are available at: www.st.com. ECOPACK® is an ST trademark.

- Epoxy meets UL94, V0
- Lead-free package

3.1 Flip-Chip 5 bumps package information

Figure 10: Flip-Chip 5 bumps package outline

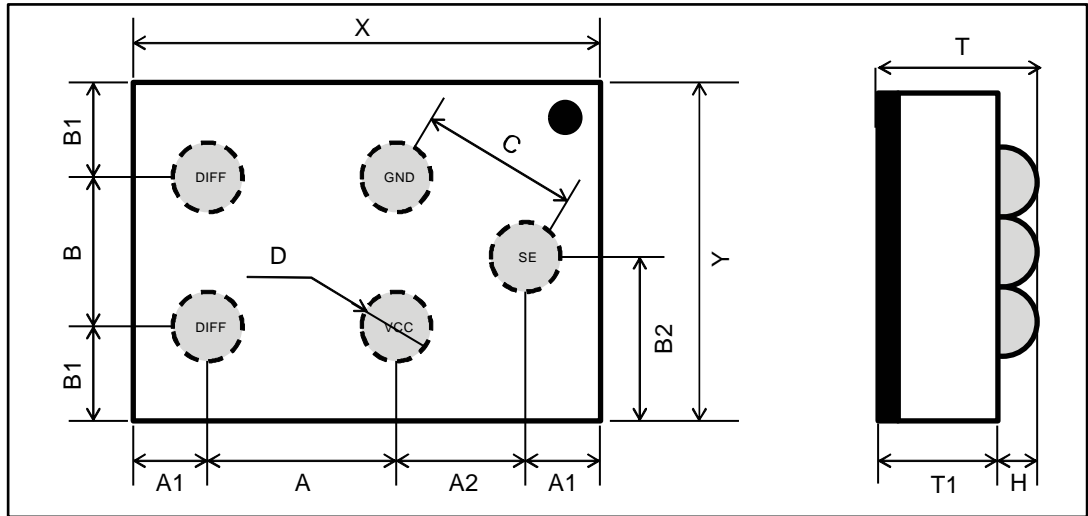
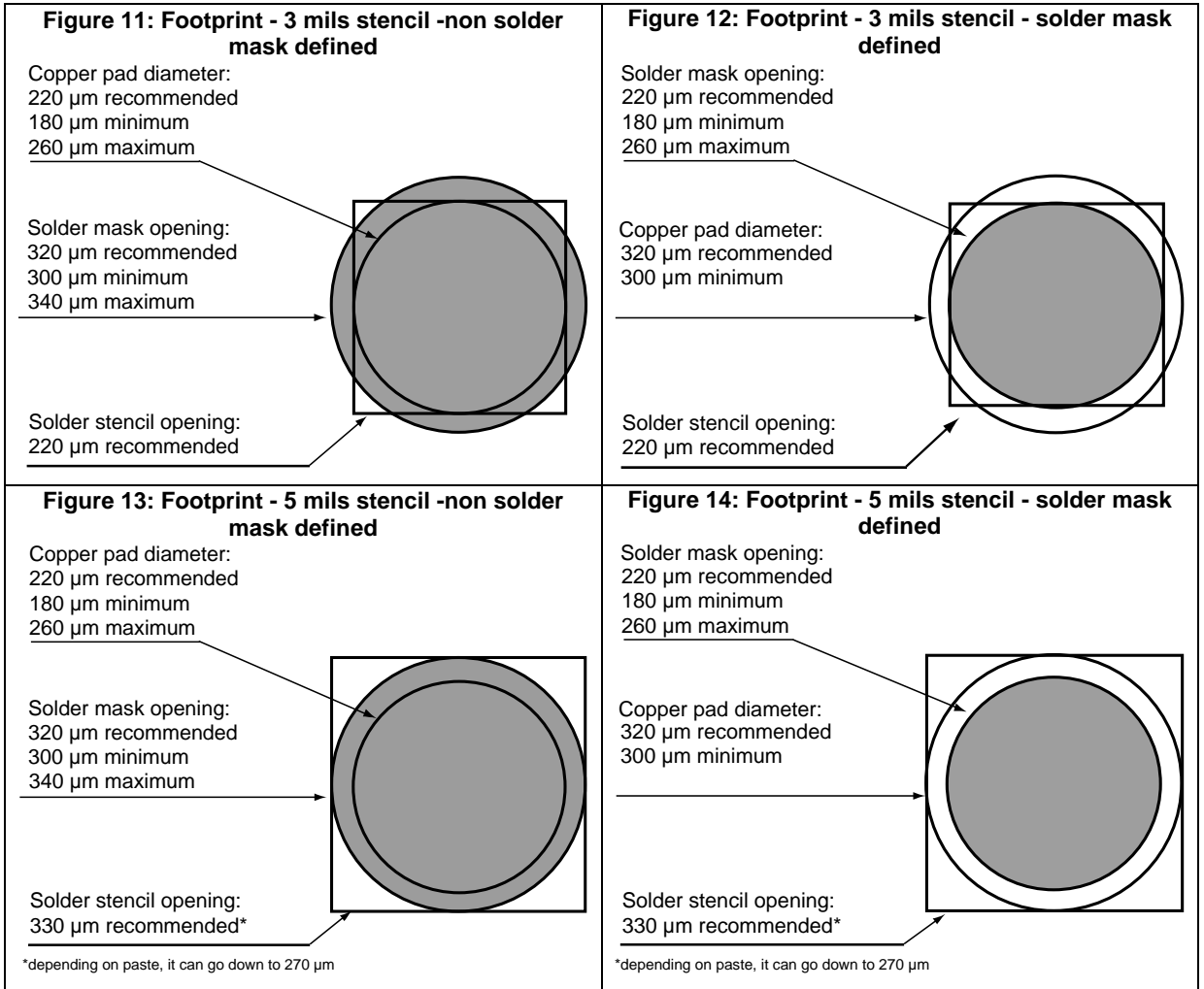

Table 4: Flip-Chip 5 bumps dimensions

Parameter	Description	Min.	Typ.	Max.	Unit
X	X dimension of the die	1445	1485	1525	mm
Y	Y dimension of the die	980	1020	1060	mm
A	X pitch		604		mm
B	Y pitch		500		mm
A1	Distance from bump to edge of die on X axis		224		mm
B1	Distance from bump to edge of die on Y axis		260		mm
A2	Distance from VCC bump to SE bump on X axis		433		mm
B2	Distance from bump to edge of die on Y axis		510		mm
C	GND, VCC bump to SE bump pitch		500		mm
D	Bump diameter	240	255	260	mm
T1	Substrate thickness		425		mm
H	Bump height		205		mm
T	Total die thickness	570	630	690	



3.2 Flip-chip 5 bumps packing information

Figure 15: Marking

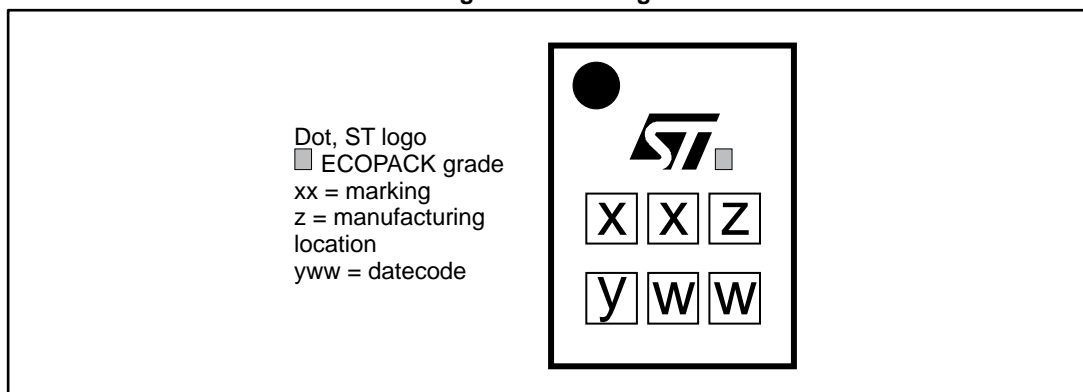
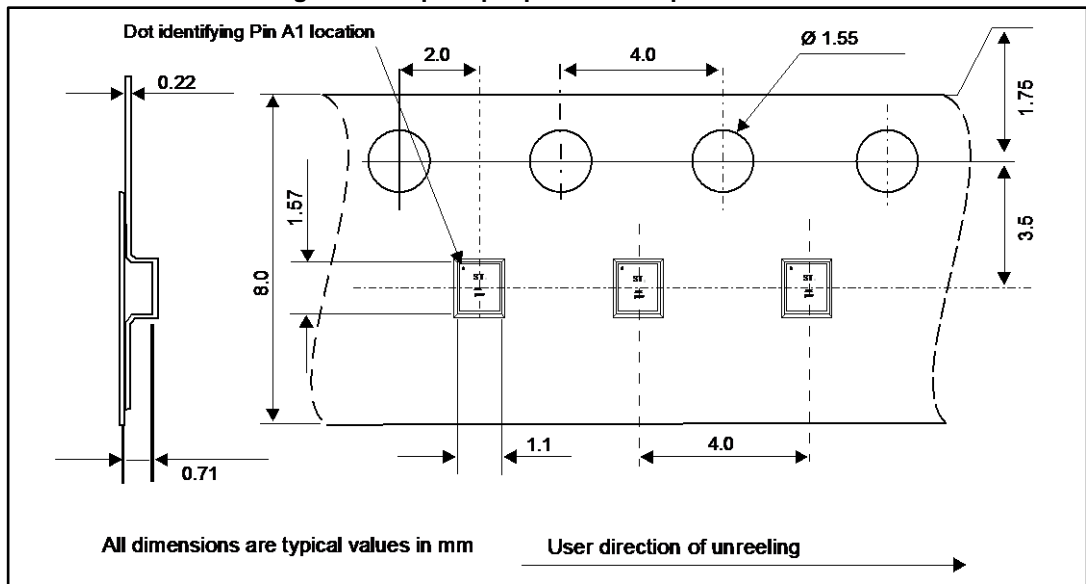

Figure 16: Flip Chip tape and reel specifications



More packing information is available in the application note:

- AN2348 Flip-Chip: "Package description and recommendations for use"
- AN4111: "BAL-NRF01D3 matched balun with integrated harmonics filter for Nordic Semiconductor chips with ultralow power transceivers"

4 Ordering information

Table 5: Ordering information

Order code	Marking	Package	Weight	Base qty.	Delivery mode
BAL-NRF01D3	SC	Flip-Chip package (5 bumps)	1.82 mg	5000	Tape and reel

5 Revision history

Table 6: Document revision history

Date	Revision	Changes
15-Oct-2012	1	First issue.
13-Nov-2012	2	Added references to nRF51 series. Added Figure 9. Updated y-axis labels in Figure 2.
04-Mar-2013	3	Updated footprint illustrations in Figure 13, and Figure 14.
06-Aug-2013	4	Added dimensions in Figure 10. Updated marking orientation in Figure 11 and Figure 12.
13-Jan-2014	5	Updated document title and product references.
07-Jul-2015	6	Updated Table 1.
21-Jun-2017	7	Updated Figure 10: "Flip-Chip 5 bumps package outline" and Table 4: "Flip-Chip 5 bumps dimensions" .

IMPORTANT NOTICE – PLEASE READ CAREFULLY

STMicroelectronics NV and its subsidiaries ("ST") reserve the right to make changes, corrections, enhancements, modifications, and improvements to ST products and/or to this document at any time without notice. Purchasers should obtain the latest relevant information on ST products before placing orders. ST products are sold pursuant to ST's terms and conditions of sale in place at the time of order acknowledgement.

Purchasers are solely responsible for the choice, selection, and use of ST products and ST assumes no liability for application assistance or the design of Purchasers' products.

No license, express or implied, to any intellectual property right is granted by ST herein.

Resale of ST products with provisions different from the information set forth herein shall void any warranty granted by ST for such product.

ST and the ST logo are trademarks of ST. All other product or service names are the property of their respective owners.

Information in this document supersedes and replaces information previously supplied in any prior versions of this document.

© 2017 STMicroelectronics – All rights reserved

Mouser Electronics

Authorized Distributor

Click to View Pricing, Inventory, Delivery & Lifecycle Information:

[STMicroelectronics:](#)

[BAL-NRF01D3](#)