

IEC Appliance Inlet C14 with Filter, Line Switch 1- or 2-pole, Front or Rear Side Mounting



Screw-on mounting
from front side



Snap-in version
from front side



Screw-on mounting
from front side, protection class II



See below:
[Approvals and Compliances](#)

Description

- Panel mount :
Screw-on version from front or rear side, snap-in version from front side
- 3 Functions :
Appliance Inlet protection class I or II , Line Switch 1- or 2-pole , Line filter in standard and medical version
- Quick connect terminals 6.3 x 0.8 mm

Unique Selling Proposition

- Compact power entry module
- Available in white or black
- Switch for high inrush current
- V-Lock cord retaining

Characteristics

- Compact design with optimal shielding
- Rear side mounting for efficient cost-saving assembly
- All single elements are already wired
- Line switch non-illuminated or illuminated
- Universal line filter for standard applications
- Ideal for application with high transient loads
- Suitable for use in equipment according to IEC/UL 60950
- Suitable for use in medical equipment according to IEC/UL 60601-1

Other versions on request

- Solder terminals
- Other rocker marking
- Capacitance CX1

References

Alternative: version without line filter [DC11](#)
 Substitute for type [KFB1](#); [KFB2](#)

Weblinks

[pdf data sheet](#), [html datasheet](#), [General Product Information](#), [Distributor-Stock-Check](#), [Accessories](#), [Detailed request for product](#), [Landing Page](#)

Newly available variants corresponding to V-Lock mating cordset. The connector is equipped with a notch intended for use with the latching cordset. The cord latching system prevents against accidental removal of the cordset.

Technical Data

| | | | |
|---------------------------------|--|-------------------------|--|
| Ratings IEC | 1 - 10A @ Ta 40 °C / 250 VAC; 50Hz | appliance inlet/-outlet | C14 / C18 acc. to IEC 60320-1, UL 498, CSA C22.2 no. 42 (for cold conditions) pin-temperature 70 °C, 10A, Protection Class I or II |
| Ratings UL/CSA | 1 - 10A @ Ta 40 °C / 250 VAC; 60Hz | Line Switch | Rocker switch 1 or 2 pole, non-illuminated or illuminated, acc. to IEC 61058-1 Technical Details |
| Leakage Current | standard < 0.5 mA (250 V / 60Hz) medical < 5 µA (250 V / 60 Hz) | Line Filter | Standard and Medical Version, IEC 60939, UL 1283, CSA C22.2 no. 8 Technical Details |
| Dielectric Strength | > 1.7 kVDC between L-N > 2.7 kVDC between L/N-PE Test voltage (2 sec) | MTBF | > 1'900'000h acc. to MIL-HB-217 F |
| Allowable Operation Temperature | -25 °C to 85 °C | | |
| Climatic Category | 25/085/21 acc. to IEC 60068-1 | | |
| IP-Protection | from front side IP40 acc. to IEC 60529 | | |
| Protection Class | Suitable for appliances with protection class I or II acc. to IEC 61140 | | |
| Terminal | Quick connect terminals 6.3 x 0.8 mm | | |
| Panel Thickness S | Screw: max 8 mm Mounting screw torque max 0.5 Nm Snap-in: 1 mm to 3 mm | | |
| Material: Housing | Thermoplastic, black / white, UL 94V-0 | | |

Approvals and Compliances

Detailed information on product approvals, code requirements, usage instructions and detailed test conditions can be looked up in [Details about Approvals](#)

SCHURTER products are designed for use in industrial environments. They have approvals from independent testing bodies according to national and international standards. Products with specific characteristics and requirements such as required in the automotive sector according to IATF 16949, medical technology according to ISO 13485 or in the aerospace industry can be offered exclusively with customer-specific, individual agreements by SCHURTER.

Approvals

The approval mark is used by the testing authorities to certify compliance with the safety requirements placed on electronic products.

Approval Reference Type: DC12

| Approval Logo | Certificates | Certification Body | Description |
|--|-------------------------------|--------------------|--|
|  | VDE Approvals | VDE | Certificate Number: 40001522 |
|  | UL Approvals | UL | UL File Number: E72928 |
|  | CQC Approvals | CQC | CQC Certificate Number: CQC18001188116 |



Product standards

Product standards that are referenced

| Organization | Design | Standard | Description |
|--|-----------------------|------------------|---|
|  | Designed according to | IEC 60320-1 | Appliance couplers for household and similar general purposes |
|  | Designed according to | IEC 60939 | Passive filters for suppressing electromagnetic interference |
|  | Designed according to | IEC 61058-1 | Switches for appliances. Part 1. General requirements |
|  | Designed according to | UL 498 | Standard for Attachment Plugs and Receptacles |
|  | Designed according to | UL 1283 | Electromagnetic interference filters |
|  | Designed according to | CSA C22.2 no. 42 | General Use Receptacles, Attachment Plugs, and Similar Wiring Devices |
|  | Designed according to | CSA C22.2 no. 8 | Electromagnetic interference (EMI) filters |







Application standards

Application standards where the product can be used

| Organization | Design | Standard | Description |
|--|--------------------------------|--------------|--|
|  | Designed for applications acc. | IEC/UL 60950 | IEC 60950-1 includes the basic requirements for the safety of information technology equipment. |
|  | Designed for applications acc. | IEC 60601-1 | Medical electrical equipment - Part 1: General requirements for basic safety and essential performance |

Compliances

The product complies with following Guide Lines

| Identification | Details | Initiator | Description |
|--|--|-------------|--|
|  | CE declaration of conformity | SCHURTER AG | The CE marking declares that the product complies with the applicable requirements laid down in the harmonisation of Community legislation on its affixing in accordance with EU Regulation 765/2008. |
|  | RoHS | SCHURTER AG | Directive RoHS 2011/65/EU, Amendment (EU) 2015/836 |
|  | China RoHS | SCHURTER AG | The law SJ / T 11363-2006 (China RoHS) has been in force since 1 March 2007. It is similar to the EU directive RoHS. |
|  | REACH | SCHURTER AG | On 1 June 2007, Regulation (EC) No 1907/2006 on the Registration, Evaluation, Authorization and Restriction of Chemicals 1 (abbreviated as "REACH") entered into force. |
|  | | SCHURTER AG | V-Lock system are based on a matching plug-dose combination. The connector is equipped with a notch intended for use with the latching cordset. The cord latching system prevents against accidental removal of the cordset. |
|  | Medical Technology | SCHURTER AG | Suitable for use in medical equipment according to IEC/UL 60601-1 |

Dimension [mm]

Screw-on mounting from front side



Screw-on mounting from rear side (metal flange)

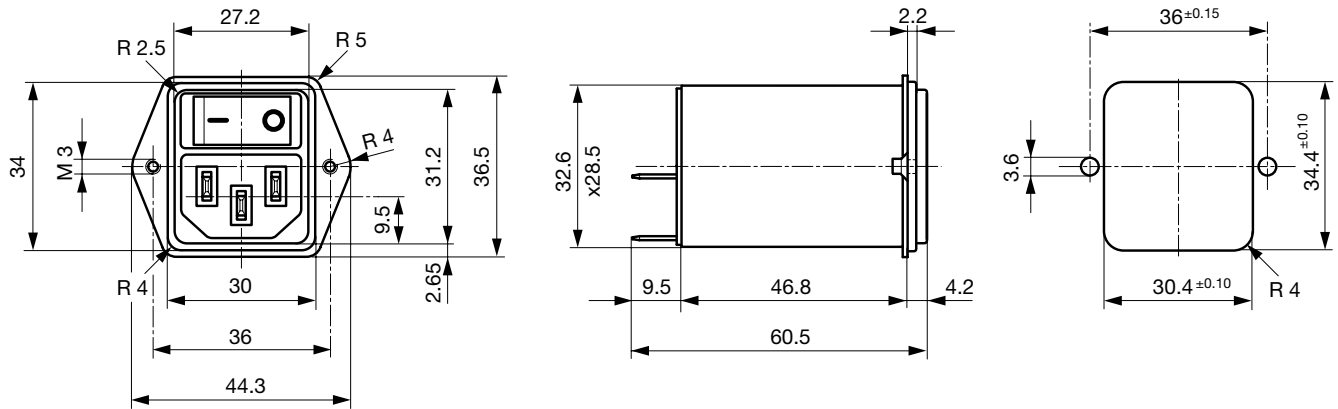

Snap-in mounting from front side



Screw-on mounting from front side (protection class II)

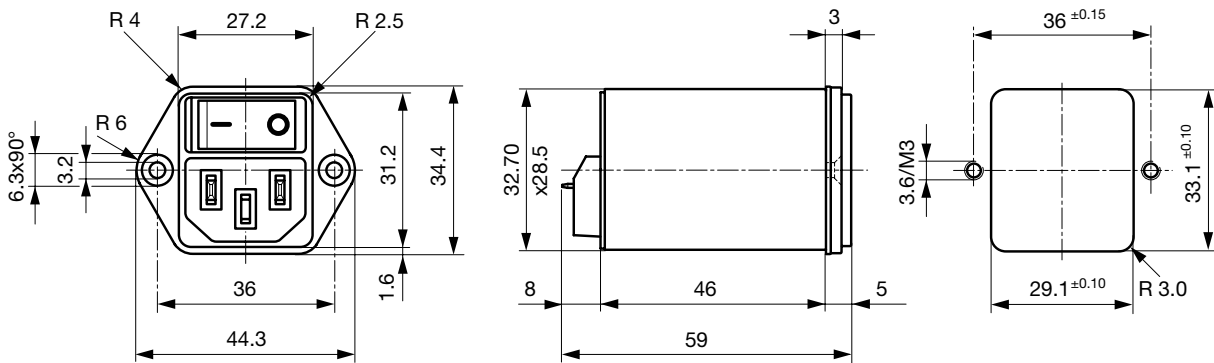

Screw-on mounting from rearside (protection class II)

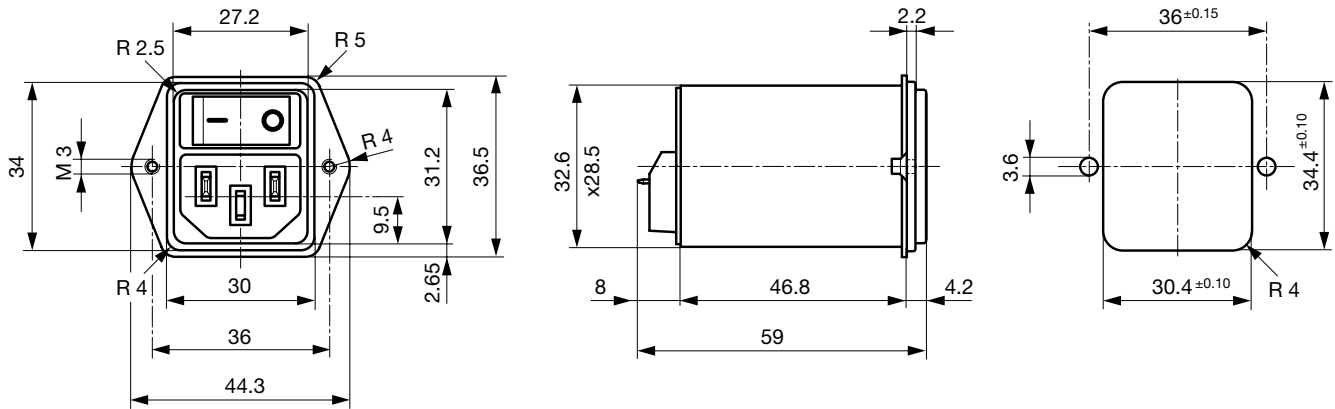

Snap-in mounting from front side (protection class II)



Technical Data of Filter-Components

| Rated Current [A] | Filter-Type | Inductances L [mH] | Capacitance CX [nF] | Capacitance CY [nF] | R [MΩ] |
|-------------------|-----------------------|--------------------|---------------------|---------------------|--------|
| 1 | Standard Version | 2 x 10 | 100 | 2.2 | 1 |
| 2 | Standard Version | 2 x 4 | 100 | 2.2 | 1 |
| 4 | Standard Version | 2 x 1.5 | 100 | 2.2 | 1 |
| 6 | Standard Version | 2 x 0.8 | 100 | 2.2 | 1 |
| 10 | Standard Version | 2 x 0.3 | 100 | 2.2 | 1 |
| 1 | Medical Version (M5) | 2 x 10 | 100 | - | 1 |
| 2 | Medical Version (M5) | 2 x 4 | 100 | - | 1 |
| 4 | Medical Version (M5) | 2 x 1.5 | 100 | - | 1 |
| 6 | Medical Version (M5) | 2 x 0.8 | 100 | - | 1 |
| 10 | Medical Version (M5) | 2 x 0.3 | 100 | - | 1 |
| 1 | Medical Version (M80) | 2 x 10 | 100 | 0.47 | 1 |
| 2 | Medical Version (M80) | 2 x 4 | 100 | 0.47 | 1 |
| 4 | Medical Version (M80) | 2 x 1.5 | 100 | 0.47 | 1 |
| 6 | Medical Version (M80) | 2 x 0.8 | 100 | 0.47 | 1 |
| 10 | Medical Version (M80) | 2 x 0.3 | 100 | 0.47 | 1 |

Diagrams

Standard filter 1-pole



1) Line
 2) Load

Standard filter 2-pole



1) Line
 2) Load

Medical filter 1-pole (M5)



1) Line
 2) Load

Medical version (M5)
 2-pole



1) Line
 2) Load

Standard filter 2-pole illuminated



1) Line
 2) Load

Medical Filter 2-pole (M5)
 illuminated



1) Line
 2) Load

Medical filter 2-pole (M5) protection class II



1) Line
 2) Load

Attenuation Loss

--- 50Ω differential mode ____ 50Ω common mode

Standard version

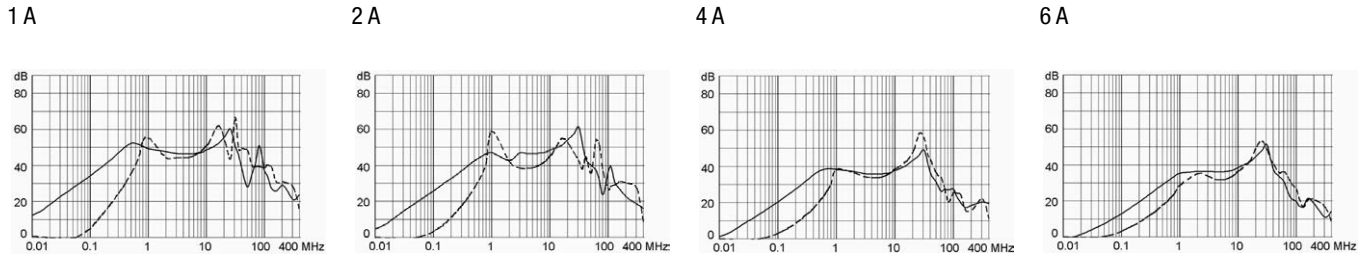

10A

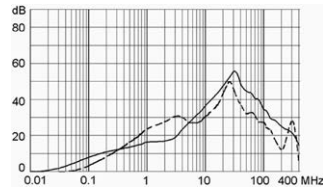

Medical version (M5)

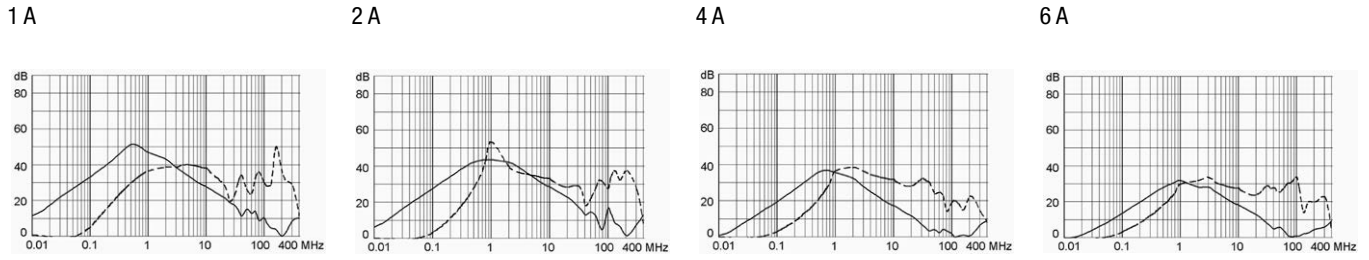

10A

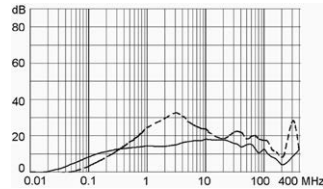

All Variants

| Rated current | Filter-Type | Panel mounting | Mounting side | Line Switch | Illumination | Color | Pro-tection | V-Lock | Order Number |
|---------------|------------------|----------------|---------------|-------------|-----------------|-------|-------------|--------|-------------------------------|
| 1 | Standard Version | Snap-in | Front Side | 1-pole | non-illuminated | black | | ● | DC12.1102.103 |
| 2 | Standard Version | Snap-in | Front Side | 1-pole | non-illuminated | black | | ● | DC12.2102.103 |
| 4 | Standard Version | Snap-in | Front Side | 1-pole | non-illuminated | black | | ● | DC12.3102.103 |
| 6 | Standard Version | Snap-in | Front Side | 1-pole | non-illuminated | black | | ● | DC12.4102.103 |
| 10 | Standard Version | Snap-in | Front Side | 1-pole | non-illuminated | black | | ● | DC12.5102.103 |
| 1 | Standard Version | Snap-in | Front Side | 2-pole | non-illuminated | black | | ● | DC12.1102.101 |
| 2 | Standard Version | Snap-in | Front Side | 2-pole | non-illuminated | black | | ● | DC12.2102.101 |
| 4 | Standard Version | Snap-in | Front Side | 2-pole | non-illuminated | black | | ● | DC12.3102.101 |
| 6 | Standard Version | Snap-in | Front Side | 2-pole | non-illuminated | black | | ● | DC12.4102.101 |
| 10 | Standard Version | Snap-in | Front Side | 2-pole | non-illuminated | black | | ● | DC12.5102.101 |
| 1 | Standard Version | Screw | Front Side | 1-pole | non-illuminated | black | | ● | DC12.1102.003 |
| 2 | Standard Version | Screw | Front Side | 1-pole | non-illuminated | black | | ● | DC12.2102.003 |
| 4 | Standard Version | Screw | Front Side | 1-pole | non-illuminated | black | | ● | DC12.3102.003 |

| Rated current | Filter-Type | Panel mounting | Mounting side | Line Switch | Illumination | Color | Pro-tection | V-Lock | Order Number |
|---------------|----------------------|----------------|---------------|-------------|-------------------|-------|-------------|--------|---------------|
| 6 | Standard Version | Screw | Front Side | 1-pole | non-illuminated | black | I | ● | DC12.4102.003 |
| 10 | Standard Version | Screw | Front Side | 1-pole | non-illuminated | black | I | ● | DC12.5102.003 |
| 1 | Standard Version | Screw | Front Side | 2-pole | non-illuminated | black | I | ● | DC12.1102.001 |
| 2 | Standard Version | Screw | Front Side | 2-pole | non-illuminated | black | I | ● | DC12.2102.001 |
| 4 | Standard Version | Screw | Front Side | 2-pole | non-illuminated | black | I | ● | DC12.3102.001 |
| 6 | Standard Version | Screw | Front Side | 2-pole | non-illuminated | black | I | ● | DC12.4102.001 |
| 10 | Standard Version | Screw | Front Side | 2-pole | non-illuminated | black | I | ● | DC12.5102.001 |
| 1 | Standard Version | Screw | Rear Side | 1-pole | non-illuminated | black | I | ● | DC12.1102.203 |
| 2 | Standard Version | Screw | Rear Side | 1-pole | non-illuminated | black | I | ● | DC12.2102.203 |
| 4 | Standard Version | Screw | Rear Side | 1-pole | non-illuminated | black | I | ● | DC12.3102.203 |
| 6 | Standard Version | Screw | Rear Side | 1-pole | non-illuminated | black | I | ● | DC12.4102.203 |
| 10 | Standard Version | Screw | Rear Side | 1-pole | non-illuminated | black | I | ● | DC12.5102.203 |
| 1 | Standard Version | Screw | Rear Side | 2-pole | non-illuminated | black | I | ● | DC12.1102.201 |
| 2 | Standard Version | Screw | Rear Side | 2-pole | non-illuminated | black | I | ● | DC12.2102.201 |
| 4 | Standard Version | Screw | Rear Side | 2-pole | non-illuminated | black | I | ● | DC12.3102.201 |
| 6 | Standard Version | Screw | Rear Side | 2-pole | non-illuminated | black | I | ● | DC12.4102.201 |
| 10 | Standard Version | Screw | Rear Side | 2-pole | non-illuminated | black | I | ● | DC12.5102.201 |
| 1 | Medical Version (M5) | Snap-in | Front Side | 1-pole | non-illuminated | black | I | ● | DC12.1202.103 |
| 2 | Medical Version (M5) | Snap-in | Front Side | 1-pole | non-illuminated | black | I | ● | DC12.2202.103 |
| 4 | Medical Version (M5) | Snap-in | Front Side | 1-pole | non-illuminated | black | I | ● | DC12.3202.103 |
| 6 | Medical Version (M5) | Snap-in | Front Side | 1-pole | non-illuminated | black | I | ● | DC12.4202.103 |
| 10 | Medical Version (M5) | Snap-in | Front Side | 1-pole | non-illuminated | black | I | ● | DC12.5202.103 |
| 1 | Medical Version (M5) | Snap-in | Front Side | 2-pole | non-illuminated | black | I | ● | DC12.1202.101 |
| 1 | Medical Version (M5) | Snap-in | Front Side | 2-pole | non-illuminated | black | II | ● | DC12.1202.121 |
| 1 | Medical Version (M5) | Snap-in | Front Side | 2-pole | non-illuminated | white | II | ● | DC12.1202.131 |
| 2 | Medical Version (M5) | Snap-in | Front Side | 2-pole | non-illuminated | black | I | ● | DC12.2202.101 |
| 2 | Medical Version (M5) | Snap-in | Front Side | 2-pole | non-illuminated | black | II | ● | DC12.2202.121 |
| 2 | Medical Version (M5) | Snap-in | Front Side | 2-pole | non-illuminated | white | II | ● | DC12.2202.131 |
| 4 | Medical Version (M5) | Snap-in | Front Side | 2-pole | non-illuminated | black | I | ● | DC12.3202.101 |
| 4 | Medical Version (M5) | Snap-in | Front Side | 2-pole | non-illuminated | black | II | ● | DC12.3202.121 |
| 4 | Medical Version (M5) | Snap-in | Front Side | 2-pole | non-illuminated | white | II | ● | DC12.3202.131 |
| 6 | Medical Version (M5) | Snap-in | Front Side | 2-pole | non-illuminated | black | I | ● | DC12.4202.101 |
| 6 | Medical Version (M5) | Snap-in | Front Side | 2-pole | non-illuminated | black | II | ● | DC12.4202.121 |
| 6 | Medical Version (M5) | Snap-in | Front Side | 2-pole | non-illuminated | white | II | ● | DC12.4202.131 |
| 10 | Medical Version (M5) | Snap-in | Front Side | 2-pole | non-illuminated | black | I | ● | DC12.5202.101 |
| 10 | Medical Version (M5) | Snap-in | Front Side | 2-pole | non-illuminated | black | II | ● | DC12.5202.121 |
| 10 | Medical Version (M5) | Snap-in | Front Side | 2-pole | non-illuminated | white | II | ● | DC12.5202.131 |
| 6 | Medical Version (M5) | Snap-in | Front Side | 2-pole | illuminated green | black | I | ● | DC12.4232.101 |
| 1 | Medical Version (M5) | Screw | Front Side | 1-pole | non-illuminated | black | I | ● | DC12.1202.003 |
| 2 | Medical Version (M5) | Screw | Front Side | 1-pole | non-illuminated | black | I | ● | DC12.2202.003 |
| 4 | Medical Version (M5) | Screw | Front Side | 1-pole | non-illuminated | black | I | ● | DC12.3202.003 |
| 6 | Medical Version (M5) | Screw | Front Side | 1-pole | non-illuminated | black | I | ● | DC12.4202.003 |
| 10 | Medical Version (M5) | Screw | Front Side | 1-pole | non-illuminated | black | I | ● | DC12.5202.003 |
| 1 | Medical Version (M5) | Screw | Front Side | 2-pole | non-illuminated | black | I | ● | DC12.1202.001 |
| 1 | Medical Version (M5) | Screw | Front Side | 2-pole | non-illuminated | black | II | ● | DC12.1202.021 |
| 1 | Medical Version (M5) | Screw | Front Side | 2-pole | non-illuminated | white | II | ● | DC12.1202.031 |
| 2 | Medical Version (M5) | Screw | Front Side | 2-pole | non-illuminated | black | I | ● | DC12.2202.001 |

| Rated current | Filter-Type | Panel mounting | Mounting side | Line Switch | Illumination | Color | Pro-tection | V-Lock | Order Number |
|---------------|-----------------------|----------------|---------------|-------------|-----------------|-------|-------------|--------|---------------|
| 2 | Medical Version (M5) | Screw | Front Side | 2-pole | non-illuminated | black | II | ● | DC12.2202.021 |
| 2 | Medical Version (M5) | Screw | Front Side | 2-pole | non-illuminated | white | II | ● | DC12.2202.031 |
| 4 | Medical Version (M5) | Screw | Front Side | 2-pole | non-illuminated | black | I | ● | DC12.3202.001 |
| 4 | Medical Version (M5) | Screw | Front Side | 2-pole | non-illuminated | black | II | ● | DC12.3202.021 |
| 4 | Medical Version (M5) | Screw | Front Side | 2-pole | non-illuminated | white | II | ● | DC12.3202.031 |
| 6 | Medical Version (M5) | Screw | Front Side | 2-pole | non-illuminated | black | I | ● | DC12.4202.001 |
| 6 | Medical Version (M5) | Screw | Front Side | 2-pole | non-illuminated | black | II | ● | DC12.4202.021 |
| 6 | Medical Version (M5) | Screw | Front Side | 2-pole | non-illuminated | white | II | ● | DC12.4202.031 |
| 10 | Medical Version (M5) | Screw | Front Side | 2-pole | non-illuminated | black | I | ● | DC12.5202.001 |
| 10 | Medical Version (M5) | Screw | Front Side | 2-pole | non-illuminated | black | II | ● | DC12.5202.021 |
| 10 | Medical Version (M5) | Screw | Front Side | 2-pole | non-illuminated | white | II | ● | DC12.5202.031 |
| 1 | Medical Version (M5) | Screw | Rear Side | 2-pole | non-illuminated | black | I | ● | DC12.1202.201 |
| 2 | Medical Version (M5) | Screw | Rear Side | 2-pole | non-illuminated | black | I | ● | DC12.2202.201 |
| 4 | Medical Version (M5) | Screw | Rear Side | 2-pole | non-illuminated | black | I | ● | DC12.3202.201 |
| 6 | Medical Version (M5) | Screw | Rear Side | 2-pole | non-illuminated | black | I | ● | DC12.4202.201 |
| 10 | Medical Version (M5) | Screw | Rear Side | 2-pole | non-illuminated | black | I | ● | DC12.5202.201 |
| 1 | Medical Version (M80) | Screw | Rear Side | 2-pole | non-illuminated | black | I | ● | DC12.1602.201 |
| 2 | Medical Version (M80) | Screw | Rear Side | 2-pole | non-illuminated | black | I | ● | DC12.2602.201 |
| 4 | Medical Version (M80) | Screw | Rear Side | 2-pole | non-illuminated | black | I | ● | DC12.3602.201 |
| 6 | Medical Version (M80) | Screw | Rear Side | 2-pole | non-illuminated | black | I | ● | DC12.4602.201 |
| 10 | Medical Version (M80) | Screw | Rear Side | 2-pole | non-illuminated | black | I | ● | DC12.5602.201 |

Most Popular.

Availability for all products can be searched real-time: <https://www.schurter.com/en/Stock-Check/Stock-Check-SCHURTER>

Packaging unit 10 Pcs

Accessories

Description



Wire Harness
 Wire harness for SCHURTER products



Cord retaining kits
 Cord retaining strain relief

Mating Outlets/Connectors

Category / Description

Connector Overview complete



| | |
|--|---------|
| 4022 Mounting: Power Supply Cord, 3 x 1.5 mm ² , Screw clamps, Connector: IEC C13 | 4022 |
| 4782 Mounting: Power Cord, 3 x 1 mm ² / 3 x 18 AWG, Cable, Connector: IEC C13 | 4782 |
| 4012 Mounting: Power Supply Cord, 3 x 1 mm ² , Screw clamps, Connector: IEC C13 | 4012 |
| 4785 Mounting: Power Cord, 3 x 1 mm ² / 3 x 18 AWG, Cable, Connector: IEC C13 | 4785 |
| 4300-06 Mounting: Power Cord, 3 x 1 mm ² / 3 x 18 AWG, Cable, Connector: IEC C13 | 4300-06 |
| Connector further types to DC12 | ... |

Interconnection Cord Overview complete



| | |
|--|-----------|
| Cord Sets 10 A, Interconnection, 1.0 m, Connector IEC C13, H05VV-F3G1.0, black | 6007.0212 |
| Cord Sets 10 A, Interconnection, 2.0 m, Connector IEC C13, H05VV-F3G1.0, black | 6007.0214 |
| Interconnection Cord further types to DC12 | ... |

Power Supply Cord Overview complete



| | |
|---|-----------|
| Cord Sets 10 A, Europlug, 2.0 m, Connector IEC C13, H05VV-F3G0.75, black | 6004.0114 |
| Cord Sets 10 A, Europlug, 2.5 m, Connector IEC C13, H05VV-F3G1.0, black | 6004.0215 |
| Cord Sets 10 A, Europlug, 2.5 m, Connector IEC C13, H05VV-F3G1.0, black | 6003.0215 |
| Cord Sets 10 A, Europlug, Black, 2.5 m, H05VV-F 3G1,0mm2, Connector IEC C13, 002500 mm, H05VV-F3G1.0, black | 6004.0225 |
| Cord Sets 10 A, diverse, Black, 5.0 m, H05VV-F 3G1,0mm2, Connector IEC C13, 002500 mm, H05VV-F3G1.0, black | 6052.0026 |
| Power Supply Cord further types to DC12 | ... |

Mating Outlets/Connectors shuttered

Power Cord Overview complete



| | |
|---|---------|
| VAC13KS, Overview, V-Lock cord retaining, diverse Connector IEC C13, diverse, black | VAC13KS |
| VAC17KS, V-Lock cord retaining, diverse m, Connector IEC C17, diverse, black / grey / white | VAC17KS |
| Power Cord further types to DC12 | ... |

Mouser Electronics

Authorized Distributor

Click to View Pricing, Inventory, Delivery & Lifecycle Information:

Schurter:

| | | | | | | |
|--------------------------------------|--------------------------------------|--------------------------------------|--------------------------------------|--------------------------------------|--------------------------------------|--------------------------------------|
| <u>DC12.1102.101</u> | <u>DC12.2202.101</u> | <u>DC12.3202.101</u> | <u>DC12.4202.101</u> | <u>DC12.1202.101</u> | <u>DC12.5102.103</u> | <u>DC12.5202.101</u> |
| <u>DC12.4102.101</u> | <u>DC12.5102.101</u> | <u>DC12.2102.101</u> | <u>DC12.3102.101</u> | <u>DC12.5202.003</u> | <u>DC12.3102.001</u> | <u>DC12.3102.003</u> |
| <u>DC12.1102.003</u> | <u>DC12.3202.003</u> | <u>DC12.1202.003</u> | <u>DC12.1202.001</u> | <u>DC12.1102.001</u> | <u>DC12.5102.001</u> | <u>DC12.5202.001</u> |
| <u>DC12.5102.003</u> | <u>DC12.3202.001</u> | <u>DC12.4202.001</u> | <u>DC12.2202.003</u> | <u>DC12.2102.003</u> | <u>DC12.4102.001</u> | <u>DC12.2202.001</u> |
| <u>DC12.4202.003</u> | <u>DC12.4102.003</u> | <u>DC12.2102.001</u> | <u>DC12.4102.103</u> | <u>DC12.5122.001</u> | <u>DC12.1102.103</u> | <u>DC12.1102.203</u> |
| <u>DC12.1122.001</u> | <u>DC12.1122.101</u> | <u>DC12.1132.001</u> | <u>DC12.1132.101</u> | <u>DC12.1202.201</u> | <u>DC12.1222.001</u> | <u>DC12.1222.101</u> |
| <u>DC12.1232.001</u> | <u>DC12.1232.101</u> | <u>DC12.1602.201</u> | <u>DC12.2102.103</u> | <u>DC12.2102.203</u> | <u>DC12.2122.001</u> | <u>DC12.2122.101</u> |
| <u>DC12.2132.001</u> | <u>DC12.2132.101</u> | <u>DC12.2222.001</u> | <u>DC12.2222.101</u> | <u>DC12.2232.001</u> | <u>DC12.2232.101</u> | <u>DC12.2602.201</u> |
| <u>DC12.3102.103</u> | <u>DC12.3102.203</u> | <u>DC12.3122.001</u> | <u>DC12.3122.101</u> | <u>DC12.3132.001</u> | <u>DC12.3132.101</u> | <u>DC12.3202.201</u> |
| <u>DC12.3222.001</u> | <u>DC12.3222.101</u> | <u>DC12.3232.001</u> | <u>DC12.3232.101</u> | <u>DC12.3602.201</u> | <u>DC12.4102.203</u> | <u>DC12.4122.001</u> |
| <u>DC12.4122.101</u> | <u>DC12.4132.001</u> | <u>DC12.4132.101</u> | <u>DC12.4202.201</u> | <u>DC12.4222.001</u> | <u>DC12.4222.101</u> | <u>DC12.4232.001</u> |
| <u>DC12.4232.101</u> | <u>DC12.4602.201</u> | <u>DC12.5102.203</u> | <u>DC12.5122.101</u> | <u>DC12.5132.001</u> | <u>DC12.5132.101</u> | <u>DC12.5202.201</u> |
| <u>DC12.5222.001</u> | <u>DC12.5222.101</u> | <u>DC12.5232.001</u> | <u>DC12.5232.101</u> | <u>DC12.5602.201</u> | <u>DC12.1102.201</u> | <u>DC12.3102.201</u> |
| <u>DC12.5102.201</u> | <u>DC12.4102.201</u> | <u>DC12.2102.201</u> | <u>DC12.5202.031</u> | <u>DC12.4202.121</u> | <u>DC12.1202.021</u> | <u>DC12.5202.021</u> |
| <u>DC12.2202.021</u> | <u>DC12.2202.031</u> | | | | | |