

IEC Appliance Outlet F, mates to Felcom

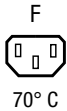

See below:

Approvals and Compliances

Description

- Component :
Snap-in version front side
- 1 Function :
Connector Protection class I
- For PCB mounting fits to Felcom

Characteristics

- Suitable for use in equipment according to IEC/UL 62368-1

Weblinks

[pdf data sheet](#), [html datasheet](#), [General Product Information](#), [Approvals](#), [Distributor-Stock-Check](#), [Accessories](#), [Detailed request for product](#)

Technical Data

| | |
|-----------------------------------|---|
| Ratings IEC | 10A / 250VAC; 50Hz |
| Ratings UL/CSA | 15A / 250VAC; 60Hz |
| Allowable Operation Temperature | -25 °C to 70 °C |
| IP-Protection | front side IP40 acc. to IEC 60529 |
| Protection against electric shock | Suitable for appliances with protection class I acc. to IEC 61140 |
| Terminal | For PCB mounting |
| Panel Thickness S | Snap-in: 1/1.2/1.5/2/2.5/3 mm |
| Material: Housing | Thermoplastic, black, UL 94V-0 |

| | |
|-------------------------|--|
| Appliance inlet/-outlet | F acc. to IEC 60320-3 UL 60320-1, CSA C22.2 no. 60320-1 (for cold conditions) pin-temperature 70 °C, 10A, Protection Class I |
|-------------------------|--|

Approvals and Compliances

Detailed information on product approvals, code requirements, usage instructions and detailed test conditions can be looked up in [Details about Approvals](#)

SCHURTER products are designed for use in industrial environments. They have approvals from independent testing bodies according to national and international standards. Products with specific characteristics and requirements such as required in the automotive sector according to IATF 16949, medical technology according to ISO 13485 or in the aerospace industry can be offered exclusively with customer-specific, individual agreements by SCHURTER.

Approvals





The approval mark is used by the testing authorities to certify compliance with the safety requirements placed on electronic products.

Approval Reference Type: 6650

| Approval Logo | Certificates | Certification Body | Description |
|---------------|-------------------------------|--------------------|--|
| | VDE Approvals | VDE | VDE Certificate Number: 40017345 |
| | UL Approvals | UL | UR File Number: E103791 |
| | CCC Approvals | CCC | CCC Certificate Number: 2020180204016734 |

Product standards

Product standards that are referenced

| Organization | Design | Standard | Description |
|--|-----------------------|-----------------------|---|
|  | Designed according to | IEC 60320-1 | Appliance couplers for household and similar general purposes |
|  | Designed according to | IEC 60320-3 | Appliance couplers for household and similar general purposes |
|  | Designed according to | IEC 61058-1 | Switches for appliances. Part 1. General requirements |
|  | Designed according to | UL 60320-1 | Standard for Attachment Plugs and Receptacles |
|  | Designed according to | CSA C22.2 no. 60320-1 | General Use Receptacles, Attachment Plugs, and Similar Wiring Devices |





Application standards

Application standards where the product can be used

| Organization | Design | Standard | Description |
|--|--------------------------------|----------------|---|
|  | Suitable for applications acc. | IEC/UL 62368-1 | Audio/video, information and communication technology equipment - Part 1: Safety requirements |

Compliances

The product complies with following Guide Lines

| Identification | Details | Initiator | Description |
|--|--|-------------|---|
|  | CE declaration of conformity | SCHURTER AG | The CE marking declares that the product complies with the applicable requirements laid down in the harmonisation of Community legislation on its affixing in accordance with EU Regulation 765/2008. |
|  | UKCA declaration of conformity | SCHURTER AG | The UKCA marking declares that the product complies with the applicable requirements laid down in the British Amendment of Regulation (EC) 765/2008. |
|  | RoHS | SCHURTER AG | Directive RoHS 2011/65/EU, Amendment (EU) 2015/863 |
|  | China RoHS | SCHURTER AG | The law SJ / T 11363-2006 (China RoHS) has been in force since 1 March 2007. It is similar to the EU directive RoHS. |
|  | REACH | SCHURTER AG | On 1 June 2007, Regulation (EC) No 1907/2006 on the Registration, Evaluation, Authorization and Restriction of Chemicals 1 (abbreviated as "REACH") entered into force. |

Dimensions [mm]

Connector

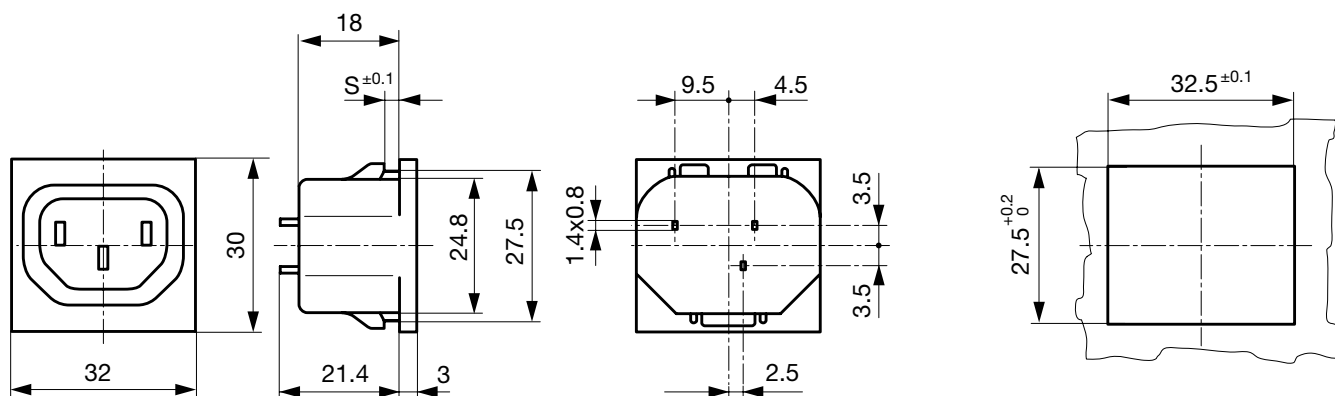

Variants

| Type | Panel Thickness s [mm] | Line Switch | Fuseholder | Connectors | Outlet | Order Number |
|------|---------------------------|-------------|------------|------------|--------|--------------|
| 6650 | 1 | - | - | - | F | 6650.4510 |
| 6650 | 1.2 | - | - | - | F | 6650.4512 |
| 6650 | 1.5 | - | - | - | F | 6650.4515 |
| 6650 | 2 | - | - | - | F | 6650.4520 |
| 6650 | 2.5 | - | - | - | F | 6650.4525 |
| 6650 | 3 | - | - | - | F | 6650.4530 |

Availability for all products can be searched real-time: <https://www.schurter.com/en/info-center/support-tools/stock-check-distributors>

Packaging unit

50 Pcs

Mating Inlets/Plugs

Category / Description

[Plug Overview complete](#)



| | |
|--|------|
| 4732, Mounting: Power Cord, Plug: IEC E, Cable | 4732 |
| 4735, Mounting: Power Cord, Plug: IEC E, Cable | 4735 |
| 9009, Mounting: Plug: IEC E, Screw clamps | 9009 |
| 4733, Mounting: Power Cord, Plug: IEC E, Cable | 4733 |
| 4736, Mounting: Power Cord, Plug: IEC E, Cable | 4736 |

...

Mouser Electronics

Authorized Distributor

Click to View Pricing, Inventory, Delivery & Lifecycle Information:

[Schurter:](#)

[6650.4512](#) [6650.4515](#) [6650.4525](#) [6650.452](#) [6650.453](#) [6650.4520](#) [6650.4530](#)