

Product availability: Stock - Normally stocked in distribution facility



Main

Range of product	Zelio Time
Product or component type	Modular timing relay
Discrete output type	Relay
Width	0.69 in (17.5 mm)
Device short name	RE17R
Time delay type	A Ac At B Bw C D Di H Ht
Time delay range	0.1...1 s 1...10 h 1...10 min 1...10 s 10...100 h 6...60 min 6...60 s
Nominal output current	8 A

Complementary

Contacts material	Cadmium free
Control type	Selector switch on front panel
[Us] rated supply voltage	24...240 V AC at 50/60 Hz 24 V DC
Voltage range	0.85...1.1 Us
Supply frequency	50...60 Hz (+/- 5 %)
Release of input voltage	10 V
Connections - terminals	Screw terminals, clamping capacity: 1 x 0.5...1 x 3.3 mm ² AWG 20...AWG 12 (solid) without cable end Screw terminals, clamping capacity: 2 x 0.5...2 x 2.5 mm ² AWG 20...AWG 14 (solid) without cable end Screw terminals, clamping capacity: 1 x 0.2...1 x 2.5 mm ² AWG 24...AWG 14 (flexible) with cable end Screw terminals, clamping capacity: 2 x 0.2...2 x 1.5 mm ² AWG 24...AWG 16 (flexible) with cable end
Tightening torque	5.31...8.85 lbf.in (0.6...1 N.m) conforming to IEC 60947-1
Housing material	Self-extinguishing
Repeat accuracy	+/- 0.5 % conforming to IEC 61812-1
Temperature drift	+/- 0.05 %/°C
Voltage drift	+/- 0.2 %/V
Setting accuracy of time delay	+/- 10 % of full scale at 25 °C conforming to IEC 61812-1
Control signal pulse width	100 ms with load in parallel typical 30 ms typical
Insulation resistance	100 MOhm at 500 V DC conforming to IEC 60664-1
Reset time	120 ms on de-energisation typical
On-load factor	100 %
Power consumption in VA	0...32 VA at 240 V AC

Power consumption in W	<= 0.6 W at 24 V DC
Minimum switching current	10 mA at 5 V DC
Maximum switching current	8 A AC/DC
Maximum switching voltage	250 V AC
Breaking capacity	<= 2000 VA
Operating frequency	10 Hz
Electrical durability	100000 cycles resistive load (8 A at 250 V AC maximum)
Mechanical durability	10000000 cycles
Dielectric strength	2.5 kV 1 mA/1 minute 50 Hz conforming to IEC 61812-1
[Uimp] rated impulse withstand voltage	5 kV (1.2/50 µs)
Power on delay	< 100 ms
Marking	CE
Creepage distance	4 kV/3 conforming to IEC 60664-1
Safety reliability data	MTTFd = 296.8 years B10d = 270000
Mounting position	Any position in relation to normal vertical mounting plane
Mounting support	35 mm DIN rail conforming to EN/IEC 60715
Local signalling	LED indicator on steady: relay energised, no timing in progress LED indicator flashing: timing in progress (80 % ON and 20 % OFF) LED indicator pulsing: relay de-energised, no timing in progress (except function Di-D, Li-L) (5 % ON and 95 % OFF)
Product weight	0.15 lb(US) (0.07 kg)

Environment

Immunity to microbreaks	<= 20 ms
Standards	2004/108/EC EN 61000-6-1 EN 61000-6-2 EN 61000-6-3 EN 61000-6-4 IEC 61812-1 2006/95/EC
Product certifications	CSA CULus GL
Ambient air temperature for storage	-22...140 °F (-30...60 °C)
Ambient air temperature for operation	-4...140 °F (-20...60 °C)
IP degree of protection	IP20 (terminal block) conforming to IEC 60529 IP40 (housing) conforming to IEC 60529 IP50 (front panel) conforming to IEC 60529
Vibration resistance	20 m/s ² (f = 10...150 Hz) conforming to IEC 60068-2-6
Shock resistance	15 gn (duration = 11 ms) conforming to IEC 60068-2-27
Relative humidity	93 % without condensation conforming to IEC 60068-2-30
Electromagnetic compatibility	Electrostatic discharge immunity test, in contact at 6 kV conforming to IEC 61000-4-2 level 3 Electrostatic discharge immunity test, in air at 8 kV conforming to IEC 61000-4-2 level 3 Susceptibility to electromagnetic fields, 80 MHz to 1 GHz at 10 V/m conforming to IEC 61000-4-3 level 3 Electrical fast transient/burst immunity test, capacitive connecting clip at 1 kV conforming to IEC 61000-4-4 level 3 Electrical fast transient/burst immunity test, direct at 2 kV conforming to IEC 61000-4-4 level 3 1.2/50 µs shock waves immunity test, differential mode at 1 kV conforming to IEC 61000-4-5 level 3 1.2/50 µs shock waves immunity test, common mode at 2 kV conforming to IEC 61000-4-5 level 3 Conducted RF disturbances, 0.15...80 MHz at 10 V conforming to IEC 61000-4-6 level 3 Voltage dips and interruptions immunity test, 1 cycle at 0 % conforming to IEC 61000-4-11 Voltage dips and interruptions immunity test, 25/30 cycles at 70 % conforming to IEC 61000-4-11 Conducted and radiated emissions conforming to EN 55022 class B

Ordering and shipping details

Category	22370 - RE, RM MISC TIMERS & COUNTERS
Discount Schedule	CP2
GTIN	00785901543633
Nbr. of units in pkg.	1
Package weight(Lbs)	0.17000000000000001
Returnability	Y
Country of origin	ID

Offer Sustainability

Sustainable offer status	Green Premium product
RoHS (date code: YYWW)	Compliant - since 1650 - Schneider Electric declaration of conformity Schneider Electric declaration of conformity
REACH	Reference not containing SVHC above the threshold
Product environmental profile	Available
Product end of life instructions	Available
California proposition 65	WARNING: This product can expose you to chemicals including:
- - - - - Substance 1	Lead and lead compounds, which is known to the State of California to cause cancer and birth defects or other reproductive harm.
- - - - - More information	For more information go to www.p65warnings.ca.gov

Width 17.5 mm

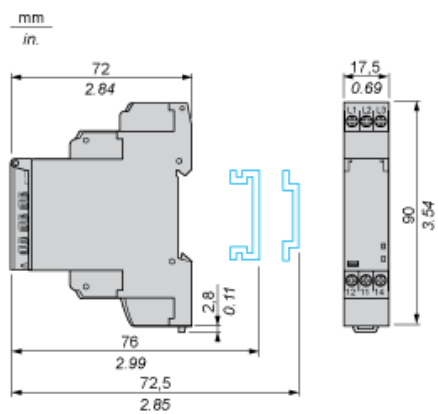

Internal Wiring Diagram

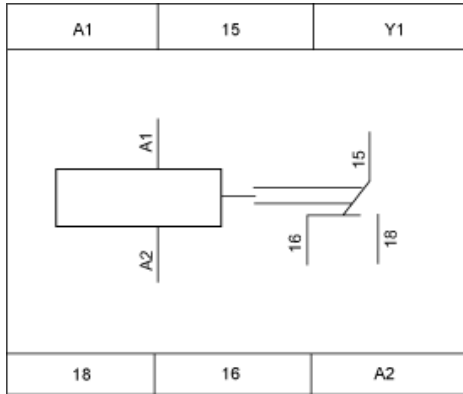

Wiring Diagram

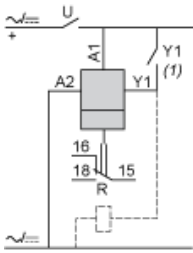

1) Contact Y1:

- Control for functions B, C, Ac, Bw, Ad, Ah, N, O, W, T, Tt.
- Partial stop for functions At, Ht and Pt.
- Function D if Di selected.
- Not used for functions A, H and P.

Function A : Power on Delay Relay

Description

The timing period T begins on energisation. After timing, the output(s) R close(s). The second output can be either timed or instantaneous.

Function: 1 Output



Function: 2 Outputs



2 timed outputs (R1/R2) or 1 timed output (R1) and 1 instantaneous output (R2 inst.)

Function Ac : On- and Off-Delay Relay with Control Signal

Description

After power-up, closing of the control contact C causes the timing period T to start (timing can be interrupted by operating the Gate control contact G). At the end of this timing period, the relay closes.

When control contact C re-opens, the timing T starts.

At the end of this timing period T, the output reverts to its initial position (timing can be interrupted by operating the Gate control contact G). The second output can be either timed or instantaneous.

Function: 1 Output

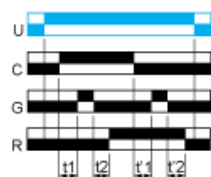

Function: 2 Outputs

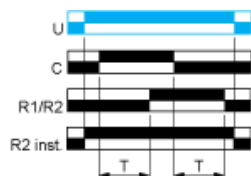

2 timed outputs (R1/R2) or 1 timed output (R1) and 1 instantaneous output (R2 inst.)

Function At : Power on Delay Relay (Summation) with Control Signal

Description

After power-up, the first opening of control contact C starts the timing. Timing can be interrupted each time control contact closes. When the cumulative total of time periods elapsed reaches the pre-set value T, the output relay closes.

Function: 1 Output

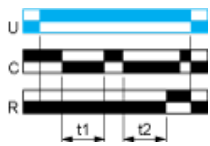

Function B : Interval Relay with Control Signal

Description

After power-up, pulsing or maintaining control contact C starts the timing T. The output R closes for the duration of the timing period T then reverts to its initial state.

Function: 1 Output

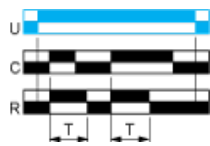

Function Bw : Double Interval Relay with Control Signal

Description

On closing and opening of control contact C, the output R closes for the duration of the timing period T.

Function: 1 Output



Function C : Off-Delay Relay with Control Signal

Description

After power-up and closing of the control contact C, the output R closes. When control contact C re-opens, timing T starts. At the end of the timing period, the output(s) R revert(s) to its/their initial state. The second output can be either timed or instantaneous.

Function: 1 Output

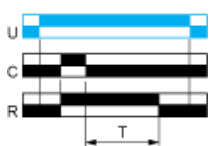

Function: 2 Outputs

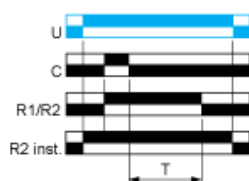

2 timed outputs (R1/R2) or 1 timed output (R1) and 1 instantaneous output (R2 inst.)

Function D : Symmetrical Flasher Relay (Starting Pulse Off)

Description

Repetitive cycle with two timing periods T of equal duration, with output(s) R changing state at the end of each timing period T. The second output can be either timed or instantaneous.

Function: 1 Output



Function: 2 Outputs

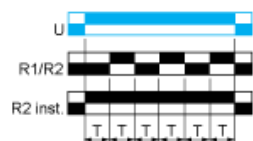

2 timed outputs (R1/R2) or 1 timed output (R1) and 1 instantaneous output (R2 inst.)

Function Di : Symmetrical Flasher Relay (Starting Pulse On)

Description

Repetitive cycle with two timing periods T of equal duration, with output(s) R changing state at the end of each timing period T. The second output can be either timed or instantaneous.

Function: 1 Output



Function: 2 Outputs

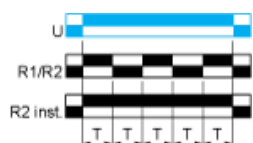

2 timed outputs (R1/R2) or 1 timed output (R1) and 1 instantaneous output (R2 inst.)

Function H : Interval Relay

Description

On energisation of the relay, timing period T starts and the output(s) R close(s). At the end of the timing period T, the output(s) R revert(s) to its/their initial state. The second output can be either timed or instantaneous.

Function: 1 Output



Function: 2 Outputs

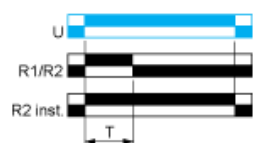

2 timed outputs (R1/R2) or 1 timed output (R1) and 1 instantaneous output (R2 inst.)

Function Ht : Interval Relay (Summation) with Control Signal

Description

On energisation, the output R closes for the duration of a timing period T then reverts to its initial state.

Pulsing or maintaining control contact C will again close the output R.

Timing T is only active when control contact C is released and so the output R will not revert to its initial state until after a time $t_1 + t_2 + \dots$

The relay memorises the total, cumulative opening time of control contact C and, once the set time T is reached, the output R reverts to its initial state.

Function: 1 Output

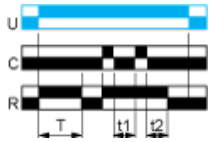

$$T = t_1 + t_2 + \dots$$

Legend

 Relay de-energised

 Relay energised

 Output open

 Output closed

C Control contact

G Gate

R Relay or solid state output

R1/ 2 timed outputs

R2

R2 The second output is instantaneous if the right position is selected
inst.

T Timing period

Ta Adjustable On-delay

-

Tr Adjustable Off-delay

-

U Supply

Mouser Electronics

Authorized Distributor

Click to View Pricing, Inventory, Delivery & Lifecycle Information:

[Schneider Electric:](#)

[RE17RMMU](#)