



EN Multifunction time relay

2459-02-001 Rev.: 0

- universal supply voltage AC/DC 12 - 240 V
- for electric appliances, controlling of the illumination, heating, motors, ventilators ...
- using for warning illumination on the road, flashers, cyclers, frequently switched systems ...
- 10 functions:
 - 5 time functions controlled via supply voltage
 - 4 time functions controlled via control input
 - 1 function of memory (latching) relay
- Time scale 0.1 s - 10 days divided into 10 ranges
- Output contact: SPDT or DPDT 16 A
- Output indication: multifunction red LED, flashing at certain states
- 1-MODULE, DIN rail mounted



This device is designed for connection of 1-phase main 12-240 V AC/DC and must be installed according to norms valid in existing state. Connections to this device must be made according to the details in this instruction sheet. Installation, connection, setting and servicing should be installed by qualified electrician staff only, who understands this instruction sheet and functions of respective device.

Before starting installation ensure that the main switch is in "SWITCH OFF" position and there should be no power going to the device. Qualified installer must also ensure the device is being installed into a temperature controlled environment which will guarantee not to exceed the specified maximal operating temperature. For installation and setting use a screw-driver with 2 mm tip.

Description

Time ranges

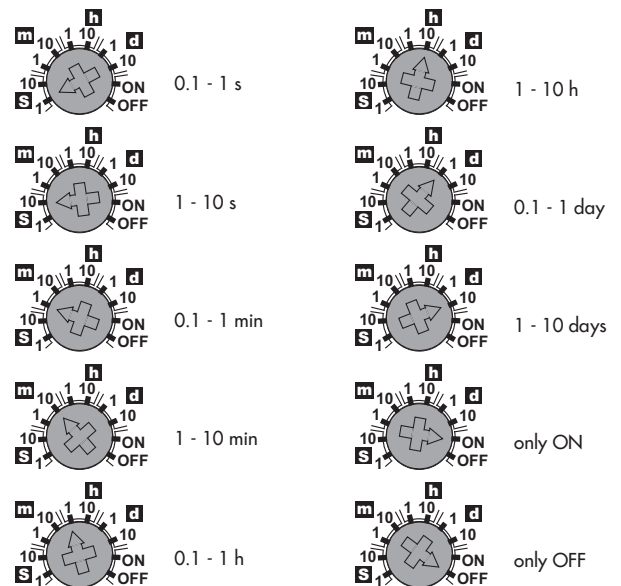
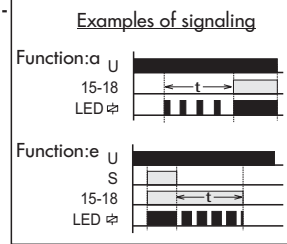
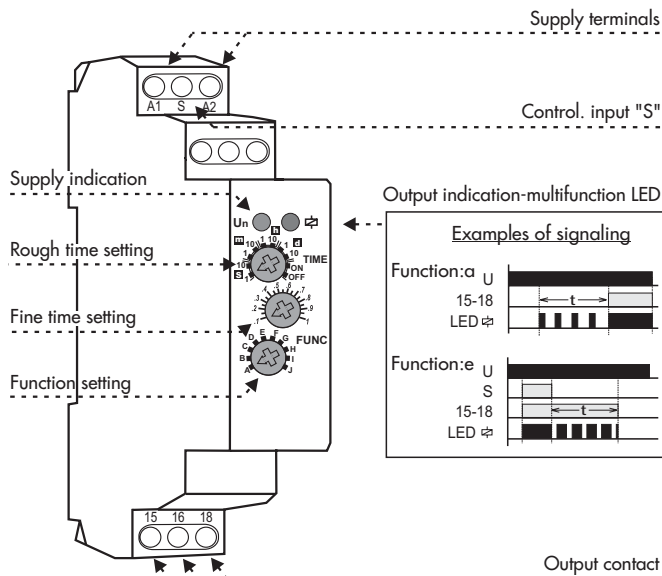

Functions

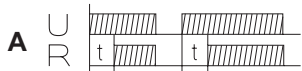

On Delay

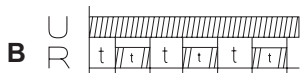

Repeat Cycle Off



Interval On

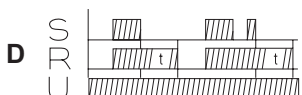

Off Delay

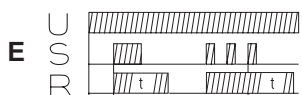

Retriggerable One Shot

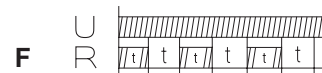

Repeat Cycle On

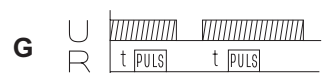

Pulse Generator

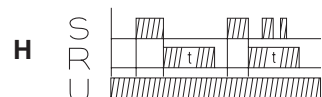

One Shot

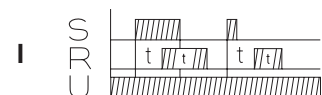

On and Off Delay

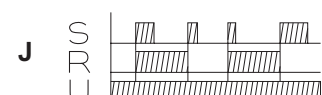

Memory latch

Technical parameters

	SPDT or DPDT
Number of functions:	10
Supply:	A1 - A2
Supply voltage:	AC/DC 12 - 240 V (AC 50-60 Hz)
Consumption:	AC 0.7 - 3 VA / DC 0.5 - 1.7 W
Supply indication:	green LED
Time ranges:	0.1 s - 10 days
Time setting:	rotary switch
Time deviation:	5 % - mechanical setting
Repeat accuracy:	0.2 % - set value stability
Temperature coefficient:	0.01 % / °C, at = 20 °C
Output	
Changeover contacts:	1, AgNi or 2, AgNi
Rated current:	16 A / AC1
Breaking capacity:	4000 VA / AC1, 384 W / DC
Inrush current:	30 A / <3 s
Switching voltage:	250 V AC1 / 24 V DC
Min. breaking capacity DC:	500 mW
Switch drop:	Y
Load-B1 terminal connection:	Y
Output indication:	multifunction red LED
Mechanical life:	3x10 ⁷
Electrical life:	0.7x10 ⁵
Reset time:	max. 150 ms
Operating temperature:	-20 .. +55 °C
Storage temperature:	-30 .. +70 °C
Electrical strength:	4 kV (supply - output)
Operating position:	any
Mounting/DIN rail:	DIN rail EN 60715
Protection degree:	IP 40
Overtoltage category:	III.
Pollution degree:	2
Max. cable size:	2.5 mm ² / with cavern 1.5 mm ²
Dimensions:	90 x 17.6 x 64 mm
Weight:	69 g
Standards:	EN 61812-1, EN 61010-1
Controlling	
Control. voltage:	at supply: AC/DC 12 - 240 V
Consumption of input:	AC/DC 12 - 240 V
Load between S-A2:	U
Glow-tubes:	Y
Control. terminals:	A1-S
Impulse length:	min. 25 ms / max. unlimited

The device is constructed for 1-phase main and must be installed in accordance with regulations and standards applicable in the country of use. While installing the device follow the instructions in this manual and on the cover packaging of the device. Do not operate the device out of the specified range of technical parameters. Installation and launching can be done only by a person with an adequate electro-technical qualification who is accredited for this work and is informed about this manual and functions of this device. The person who executes the installation is responsible for correct and safe installation of this device. Keep in mind that it is a fully electronic device when mounting. Non problematic function of the device also depends on the previous way of transportation, storing and handling. If you find any sign of damage, deformation, malfunction or a missing part, do not install this device and claim it at its seller. After the expiry date of the product it is possible to demount, recycle, and store it at protected dumping site.

1) Protection of the device

- the device contains protections against over-voltage peaks, and disturbing pulses in the main. To ensure correct function of these protective elements, suitable protections of higher degree (A,B,C) must be mounted into the installation, and screening of switched devices (contactors, motors, inductive loads etc.) must be applied.
- it is convenient to ensure protection of the device by adequate elements of over-current and over-voltage protection fuses, surge voltage protector

2) Operating conditions

- while installing this device it is necessary to consider temperature rate of ambient devices so the operation temperature stated in technical parameters is kept. It is necessary to ensure air circulation so the operation temperature is not exceeded in any case.
- to ensure the stated operating life and correct function of the device, it is not recommended to expose these to extreme influences that can negatively effect correct function of the device permanent exposure to temperatures (see technical parameters), aggressive evaporations, chemicals, high relative humidity above 95%, strong electromagnetic field of microwave radiation etc.
- it is necessary to avoid placing devices close to sources of electromagnetic disturbances to ensure their correct function
- all our products are in compliance with requirements of EMC (electromagnetic immunity and resistance) and in accordance with governmental regulation. However it is necessary to pay attention while connecting products to the circuit with appliances that create electromagnetic disturbances (conductors, motors), or power cables close to them. It is recommended to have the connection cables of a product (supply and operating inputs) as short as possible and have them led separately into power conductors. In case of connecting product into a circuit with conductors or motors, it is necessary to protect the product by adequate external protective elements RC elements, varistors or surge voltage protectors

3) Handling the device and its use

- use a screwdriver with an approximate width 2mm for installation and setting
- do not use brute force to screw input terminals (maximally 0,5N/m), do not put exceeded pressure on to the holding parts of terminals so the inner construction of the device is not damaged.
- protect the device against falls and excessive vibrations
- do not overload relay output contacts, mainly while using loads of another category then AC-1
- if contacts of relay melted while switching big loads, it is necessary to use an inserted contactor or power relay rated for required load in the current installation.

Description of protective elements in devices

All timers and monitoring relays in our assortment are equipped by protective elements against possible over-voltage in the main. The nominal voltage of the applied varistors is 275V. During short-time over-voltage peaks, the varistor lowers its leakage resistance and accumulates the grown over-voltage peaks. In case this over-voltage has a character of short-time peak, varistor is able to react repeatedly this way and thus non-destructively protect a device against these negative influences. Other protective elements that are used in devices are transils a zener diodes, that eliminate over-voltage pulses, and are installed in supply and input circuits of the device (for example when switching inductive loads). In case of switching loads of inductive character it is recommended to separate supply of output elements (motors, contactors, etc.) from supply of monitoring and controlling inputs of

Connection

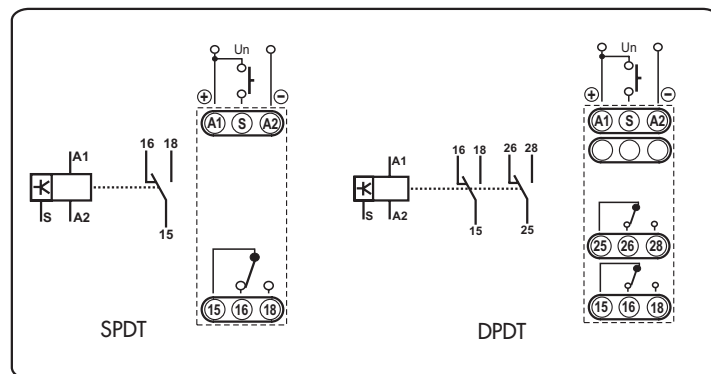

RELAY CONTACT 16 A	LOAD								
						AC1	AC3	AC15	DC1 (24/110/220 V)
AgNi	1000 W					4000 VA	0.9 kW	750 VA	16 A/0.5 A/0.35 A

Mouser Electronics

Authorized Distributor

Click to View Pricing, Inventory, Delivery & Lifecycle Information:

[Schneider Electric:](#)

[821TD10H-UNI](#) [822TD10H-UNI](#)