

725 Power Relays

GENERAL SPECIFICATIONS



Plug-In Socket Mount
Full-feature cover



Panel/DIN Mount
with quick connect terminals



Panel/DIN Mount
with screw terminals



CONTACT CHARACTERISTICS		725AXX	725BXX
Contact configuration		SPST-NO	DPST-NO
Contact material		Silver Alloy	
Thermal (carrying) current		30 A	25 A
Maximum switching voltage		300 V	
Ratings at voltage	General Purpose/ Resistive	30 A @ 277 VAC 50/60Hz 30 A @ 30 VDC	25 A @ 277 VAC 50/60Hz 25 A @ 30 VDC
	Motor	3.0 HP @ 277 VAC 50/60Hz 1.5 HP @ 120 VAC 50/60Hz	2.0 HP @ 277 VAC 50/60Hz 1.0 HP @ 120 VAC 50/60Hz
	Tungsten	1.5 kW @ 120 VAC 50/60Hz	1.3 kW @ 120 VAC 50/60Hz
	Minimum switching requirement	100 mA @ 5 VDC (0.5W)	
COIL CHARACTERISTICS			
Voltage range		6 to 240 VAC 50/60Hz 6 to 110/125 VDC	
Operating range (% of nominal)		75% to 110%	
Average consumption		2.5 VA ~ 1.9 W ==	
Insulation system per UL 508		Class B (130 °C)	
PERFORMANCE CHARACTERISTICS			
Electrical life at rated load (AC-1 resistive)		100,000 operations	
Mechanical life at no load (unpowered)		5,000,000 operations	
Operate time at nominal coil voltage		30 ms (max)	
Release time at nominal coil voltage		30 ms (max)	
Dielectric strength	Coil to Contacts	4,000 Vrms	
	Across Open Contacts	2,000 Vrms	
	Pole to Pole	2,000 Vrms (DPST-NO version only)	
	Insulation Resistance	1,000 megaohms @ 500 VDC (minimum)	
GENERAL CHARACTERISTICS			
Ambient air temperature	Operation	-20 to 55 °C	
	Storage	-50 to 100 °C	
QC terminals	0.25 x 0.031 in (6.35 x 0.80 mm)		
Screw terminals	Coil: M3.5 combination head; Contacts: M4 combination head		
Screw terminal torque	Coil & load: 1.2 Nm (10.6 lb-in) nominal; 2.3 Nm (20.3 lb-in) maximum		
Screw terminal maximum wire gauge	Load: 10 AWG (5.26 mm2); Coil: 12 AWG (3.3 mm2)		
Product certifications	UL, CSA, CE, RoHS		
Cover protection category	IP 20 (screw terminals only)		
Weight (average)	4.2 oz (120 g)		

PART NUMBER EXPLANATION

725 BXX B C3 ML - 24D

Series: 725

Contact Arrangement:
 AXX = SPST-NO
 BXX = DPST-NO

Terminal Style:
 B = Blade (Plug-In or Quick Connect)
 S = Screw Terminal

Mount Option:
 C3 = Panel/DIN Mount
 Null = Plug-In Socket Mount (Full-Feature Cover)

Standard Features:
 M = Side Pushbutton (Panel/DIN Mount)
 M4 = Lockable Push Button & Flag (Plug-In Socket Mount)
 L = LED Indicator

Coil Voltage:

6A = 6 VAC	6D = 6 VDC
12A = 12 VAC	12D = 12 VDC
24A = 24 VAC	24D = 24 VDC
48A = 48 VAC	48D = 48 VDC
120A = 120 VAC	110D = 110/125 VDC
240A = 240 VAC	

RELAY DIMENSIONS

shown in inches (millimeters)

PLUG-IN SOCKET MOUNT (BLADE TERMINAL)

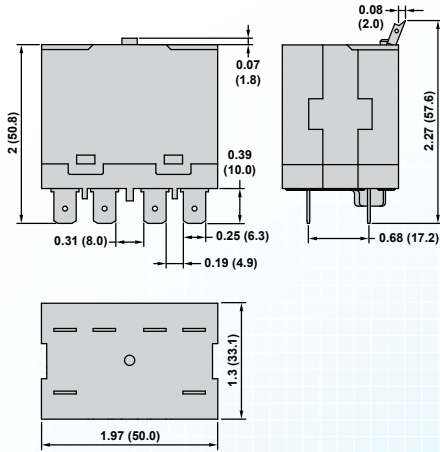

C3 - PANEL/DIN MOUNT (QC/SOLDER TERMINAL)

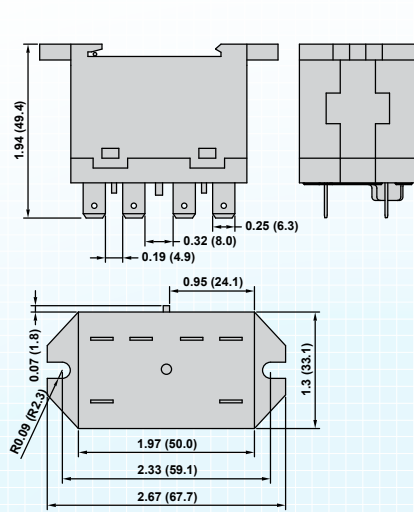

C3 - PANEL/DIN MOUNT (SCREW TERMINAL)

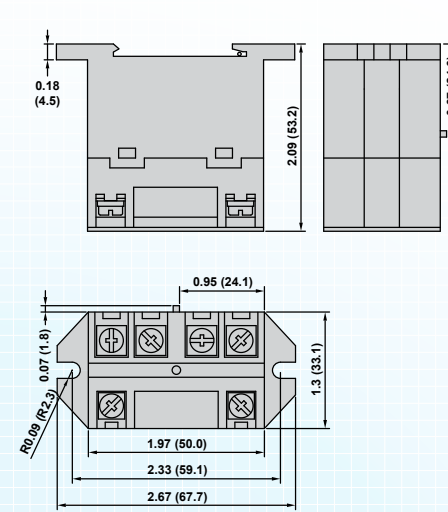

RELAY WIRING DIAGRAMS

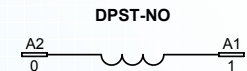
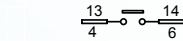
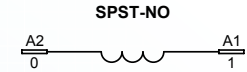

70-725-1 Socket

GENERAL SPECIFICATIONS



GENERAL SPECIFICATIONS		70-725-1
Number of terminals		6
Nominal voltage rating		300 V
Nominal current rating		30 A
Dielectric strength	Output to adjacent output terminals	1600 Vrms
	Output to input terminals	1600 Vrms
	Terminals to rail/chassis	1600 Vrms
Temperature range	Operation	-40 to +80 °C
	Storage	-40 to +105 °C
Protection category (finger-safe)		IP 20
Internal metal tracks		Copper alloy, Tin plated
Screw terminals		Steel, Zinc plated combination head
Maximum screw torque		10.6 lb-in (1.2 Nm)
Mounting style		35 mm DIN rail
Maximum wire size	Solid Cu (2)	10/20 AWG; 6.0/0.5 mm ²
	Stranded Cu (2)	10/20 AWG; 6.0/0.5 mm ²
Flammability rating		94V-0
Weight		2.4 oz (67 g)

SOCKET DIMENSIONS & WIRING DIAGRAM

shown in inches (millimeters)

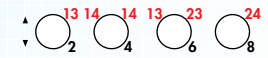
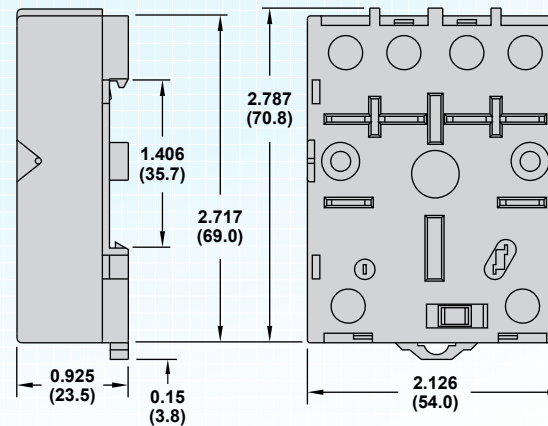

Mouser Electronics

Authorized Distributor

Click to View Pricing, Inventory, Delivery & Lifecycle Information:

Schneider Electric:

[725AXXBC3ML120A](#) [725AXXBC3ML240A](#) [725AXXBC3ML24D](#) [725AXXSC3ML120A](#) [725AXXSC3ML12D](#)
[725BXXSC3ML24D](#) [725AXXSC3ML240A](#) [725AXXSC3ML24D](#) [725BXXBC3ML120A](#) [725BXXBM4L120A](#)
[725BXXSC3ML120A](#) [725BXXSC3ML240A](#)