

Ambient Light Sensor IC Series

Digital 16bit Serial Output Type Ambient Light Sensor IC

BH1750FVI

No.11046EDT01

●Descriptions

BH1750FVI is an digital Ambient Light Sensor IC for I²C bus interface. This IC is the most suitable to obtain the ambient light data for adjusting LCD and Keypad backlight power of Mobile phone. It is possible to detect wide range at High resolution. (1 - 65535 lx).

●Features

- 1) I²C bus Interface (f / s Mode Support)
- 2) Spectral responsibility is approximately human eye response
- 3) Illuminance to Digital Converter
- 4) Wide range and High resolution. (1 - 65535 lx)
- 5) Low Current by power down function
- 6) 50Hz / 60Hz Light noise reject-function
- 7) 1.8V Logic input interface
- 8) No need any external parts
- 9) Light source dependency is little. (ex. Incandescent Lamp. Fluorescent Lamp. Halogen Lamp. White LED. Sun Light)
- 10) It is possible to select 2 type of I²C slave-address.
- 11) Adjustable measurement result for influence of optical window
(It is possible to detect min. 0.11 lx, max. 100000 lx by using this function.)
- 12) Small measurement variation (+/- 20%)
- 13) The influence of infrared is very small.

●Applications

Mobile phone, LCD TV, NOTE PC, Portable game machine, Digital camera, Digital video camera, PDA, LCD display

●Absolute Maximum Ratings

Parameter	Symbol	Ratings	Units
Supply Voltage	Vmax	4.5	V
Operating Temperature	Topr	-40~85	°C
Storage Temperature	Tstg	-40~100	°C
SDA Sink Current	I _{max}	7	mA
Power Dissipation	Pd	260*	mW

* 70mm × 70mm × 1.6mm glass epoxy board. Derating is done at 3.47mW/°C for operating above Ta=25°C.

●Operating Conditions

Parameter	Symbol	Ratings			Units
		Min.	Typ.	Max.	
Vcc Voltage	Vcc	2.4	3.0	3.6	V
I ² C Reference Voltage	V _{DVI}	1.65	-	Vcc	V

●Electrical Characteristics (Vcc = 3.0V, DVI = 3.0V, Ta = 25°C, unless otherwise noted)

Parameter	Symbol	Limits			Units	Conditions
		Min.	Typ.	Max.		
Supply Current	Icc1	—	120	190	μA	Ev = 100 lx ※ ¹
Powerdown Current	Icc2	—	0.01	1.0	μA	No input Light
Peak Wave Length	λp	—	560	—	nm	
Measurement Accuracy	S/A	0.96	1.2	1.44	times	Sensor out / Actual lx EV = 1000 lx ※ ¹ , ※ ²
Dark (0 lx) Sensor out	S0	0	0	3	count	H-Resolution Mode ※ ³
H-Resolution Mode Resolution	rHR	—	1	—	lx	
L-Resolution Mode Resolution	rLR	—	4	—	lx	
H-Resolution Mode Measurement Time	tHR	—	120	180	ms	
L-Resolution Mode Measurement Time	tLR	—	16	24	ms	
Incandescent / Fluorescent Sensor out ratio	rIF	—	1	—	times	EV = 1000 lx
ADDR Input 'H' Voltage	VAH	0.7 * VCC	—	—	V	
ADDR Input 'L' Voltage	VAL	—	—	0.3 * VCC	V	
DVI Input 'L' Voltage	VDVL	—	—	0.4	V	
SCL, SDA Input 'H' Voltage 1	VIH1	0.7 * DVI	—	—	V	DVI ≥ 1.8V
SCL, SDA Input 'H' Voltage 2	VIH2	1.26	—	—	V	1.65V ≤ DVI < 1.8V
SCL, SDA Input 'L' Voltage 1	VIL1	—	—	0.3 * DVI	V	DVI ≥ 1.8V
SCL, SDA Input 'L' Voltage 2	VIL2	—	—	DVI - 1.26	V	1.65V ≤ DVI < 1.8V
SCL, SDA, ADDR Input 'H' Current	IiH	—	—	10	μA	
SCL, SDA, ADDR Input 'L' Current	IiL	—	—	10	μA	
I ² C SCL Clock Frequency	fSCL	—	—	400	kHz	
I ² C Bus Free Time	tBUF	1.3	—	—	μs	
I ² C Hold Time (repeated) START Condition	tHDSTA	0.6	—	—	μs	
I ² C Set up time for a Repeated START Condition	tsUSTA	0.6	—	—	μs	
I ² C Set up time for a Repeated STOP Condition	tsUSTD	0.6	—	—	μs	
I ² C Data Hold Time	tHDDAT	0	—	0.9	μs	
I ² C Data Setup Time	tsUDAT	100	—	—	ns	
I ² C 'L' Period of the SCL Clock	tLOW	1.3	—	—	μs	
I ² C 'H' Period of the SCL Clock	tHIGH	0.6	—	—	μs	
I ² C SDA Output 'L' Voltage	VOL	0	—	0.4	V	IOL = 3 mA

※¹ White LED is used as optical source.

※² Measurement Accuracy typical value is possible to change '1' by "Measurement result adjustment function".

※³ Use H-resolution mode or H-resolution mode2 if dark data (less than 10 lx) is need.

●Reference Data

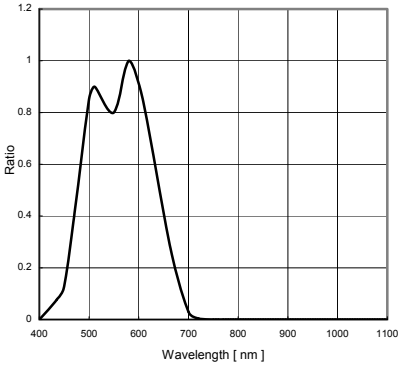

Fig.1 Spectral Response

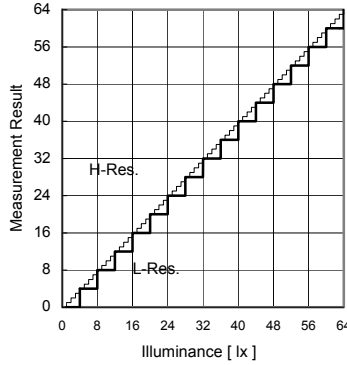

Fig.2 Illuminance - Measurement Result 1

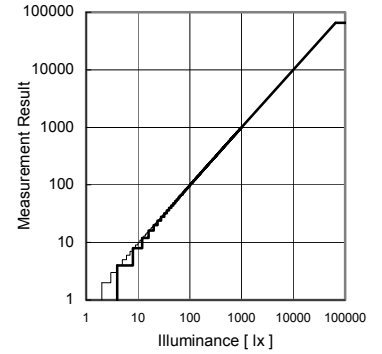

Fig.3 Illuminance - Measurement Result 2

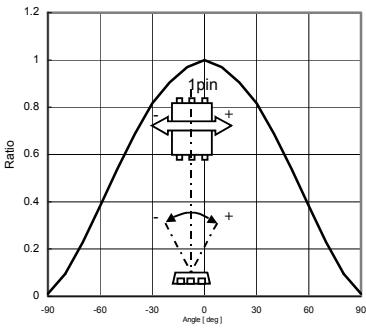

Fig.4 Directional Characteristics 1

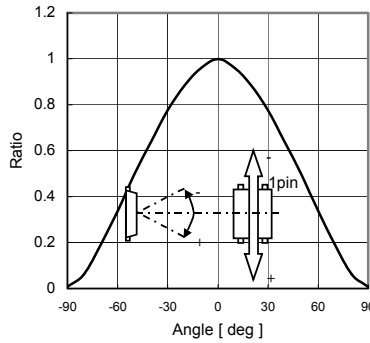

Fig.5 Directional Characteristics 2

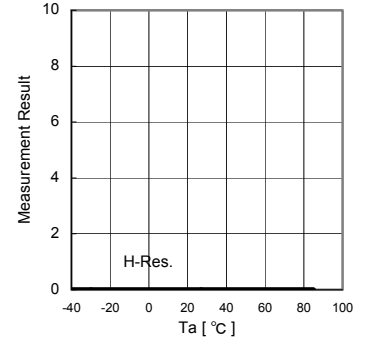

Fig.6 Dark Response

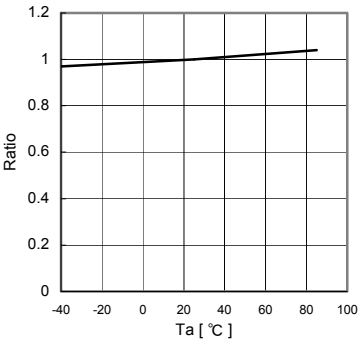

Fig.7 Measurement Accuracy Temperature Dependency

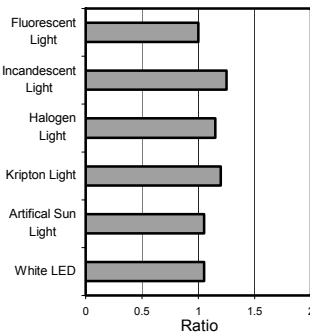

Fig.8 Light Source Dependency (Fluorescent Light is set to '1')

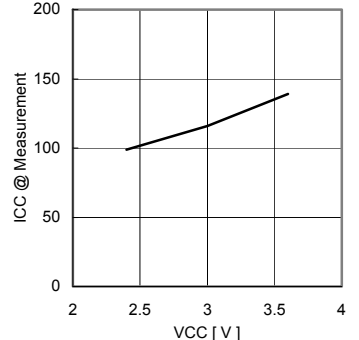

Fig.9 VCC - ICC (During measurement)

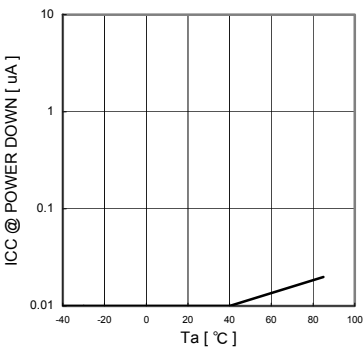

Fig.10 VCC - ICC@0 Lx (POWER DOWN)

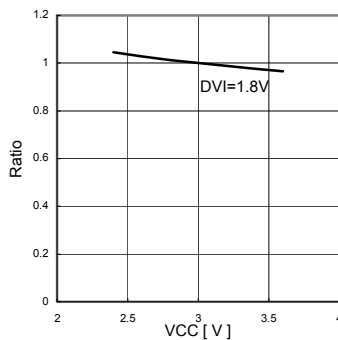

Fig.11 Measurement Result VCC Dependency

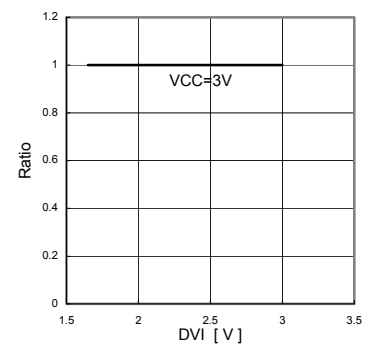
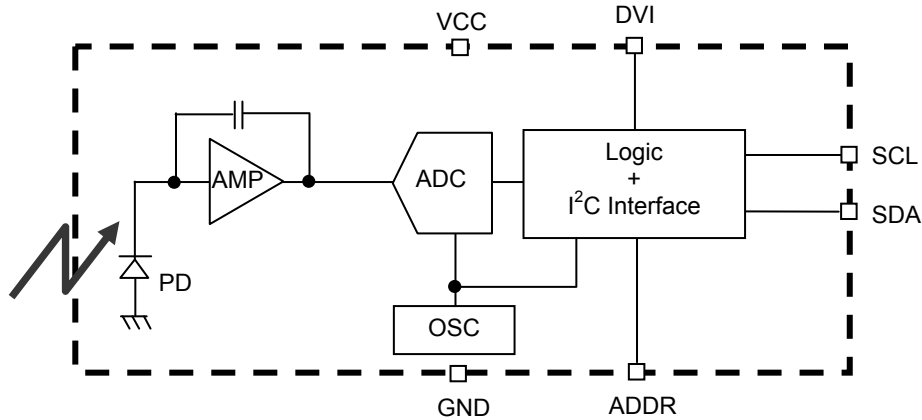

Fig.12 Measurement Result DVI Dependency

●Block Diagram



●Block Diagram Descriptions

- PD
Photo diode with approximately human eye response.
- AMP
Integration-OPAMP for converting from PD current to Voltage.
- ADC
AD converter for obtainment Digital 16bit data.
- Logic + I²C Interface
Ambient Light Calculation and I²C BUS Interface. It is including below register.
Data Register → This is for registration of Ambient Light Data. Initial Value is "0000_0000_0000_0000".
Measurement Time Register → This is for registration of measurement time. Initial Value is "0100_0101".
- OSC
Internal Oscillator (typ. 320kHz). It is CLK for internal logic.

●Measurement Procedure

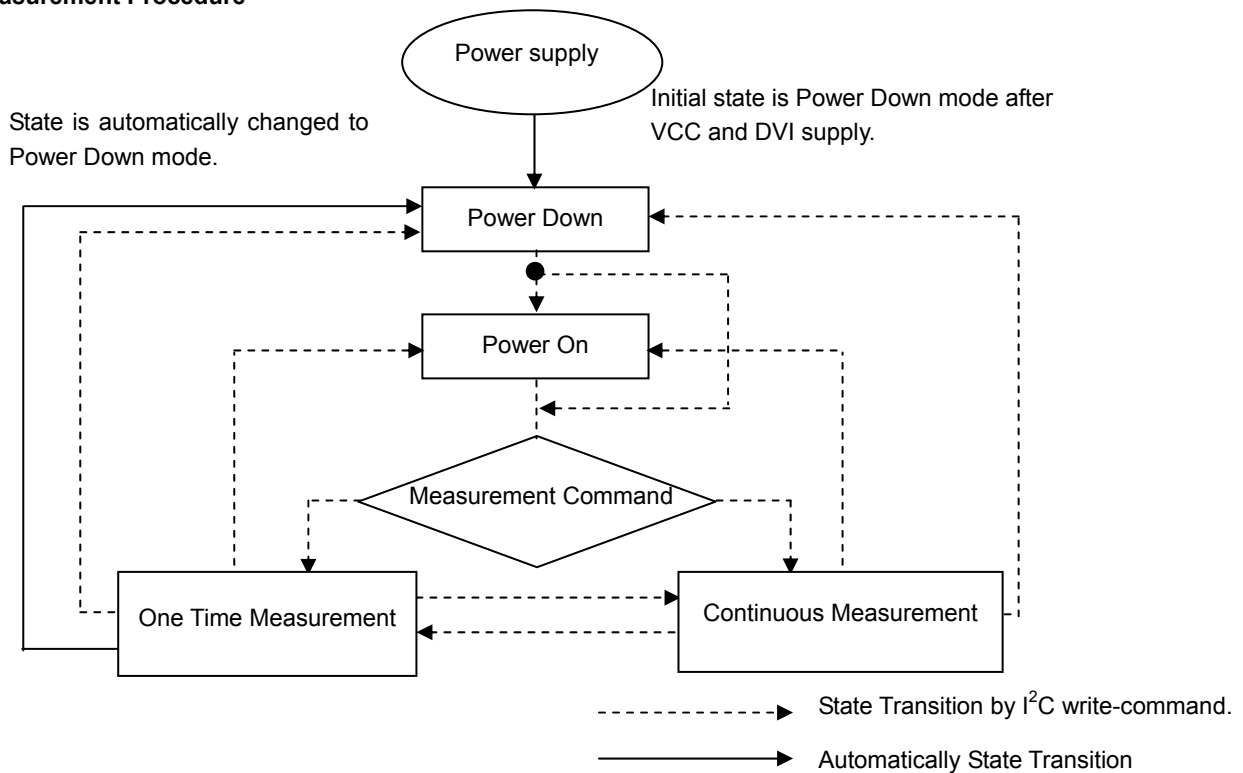

* "Power On" Command is possible to omit.

●Instruction Set Architecture

Instruction	Opecode	Comments
Power Down	0000_0000	No active state.
Power On	0000_0001	Waiting for measurement command.
Reset	0000_0111	Reset Data register value. Reset command is not acceptable in Power Down mode.
Continuously H-Resolution Mode	0001_0000	Start measurement at 1lx resolution. Measurement Time is typically 120ms.
Continuously H-Resolution Mode2	0001_0001	Start measurement at 0.5lx resolution. Measurement Time is typically 120ms.
Continuously L-Resolution Mode	0001_0011	Start measurement at 4lx resolution. Measurement Time is typically 16ms.
One Time H-Resolution Mode	0010_0000	Start measurement at 1lx resolution. Measurement Time is typically 120ms. It is automatically set to Power Down mode after measurement.
One Time H-Resolution Mode2	0010_0001	Start measurement at 0.5lx resolution. Measurement Time is typically 120ms. It is automatically set to Power Down mode after measurement.
One Time L-Resolution Mode	0010_0011	Start measurement at 4lx resolution. Measurement Time is typically 16ms. It is automatically set to Power Down mode after measurement.
Change Measurement time (High bit)	01000_MT[7,6,5]	Change measurement time. ※ Please refer "adjust measurement result for influence of optical window."
Change Measurement time (Low bit)	011_MT[4,3,2,1,0]	Change measurement time. ※ Please refer "adjust measurement result for influence of optical window."

※ Don't input the other opecode.

●Measurement mode explanation

Measurement Mode	Measurement Time.	Resolurition
H-resolution Mode2	Typ. 120ms.	0.5 lx
H-Resolution Mode	Typ. 120ms.	1 lx.
L-Resolution Mode	Typ. 16ms.	4 lx.

We recommend to use H-Resolution Mode.

Measurement time (integration time) of H-Resolution Mode is so long that some kind of noise(including in 50Hz / 60Hz noise) is rejected. And H-Resolution Mode is 1 lx resolution so that it is suitable for darkness (less than 10 lx)
H-resolution mode2 is also suitable to detect for darkness.

●Explanation of Asynchronous reset and Reset command "0000_0111"

1) Asynchronous reset

All registers are reset. It is necessary on power supply sequence. Please refer "Timing chart for VCC and DVI power supply sequence" in this page. It is power down mode during DVI = 'L'.

2) Reset command

Reset command is for only reset Illuminance data register. (reset value is '0') It is not necessary even power supply sequence. It is used for removing previous measurement result. This command is not working in power down mode, so that please set the power on mode before input this command.

●Timing chart for VCC and DVI power supply sequence

DVI is I²C bus reference voltage terminal. And it is also asynchronous reset terminal. It is necessary to set to 'L' after Vcc is supplied. In DVI 'L' term, internal state is set to Power Down mode.

1) Recommended Timing chart1 for VCC and DVI supply.

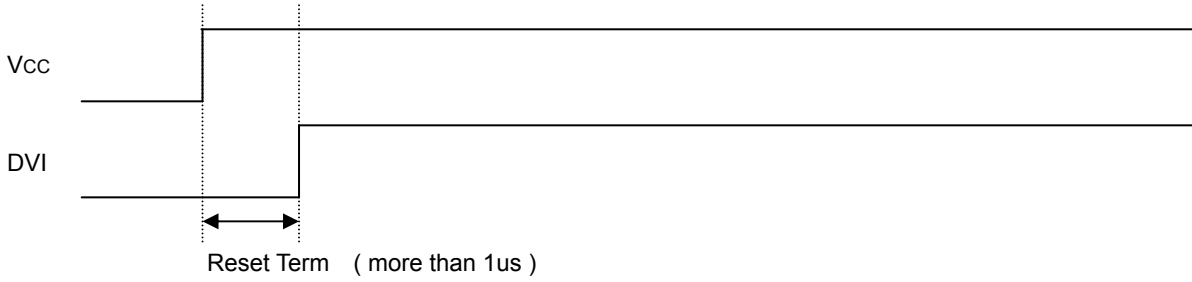

2) Timing chart2 for VCC and DVI supply.
(If DVI rises within 1μs after VCC supply)

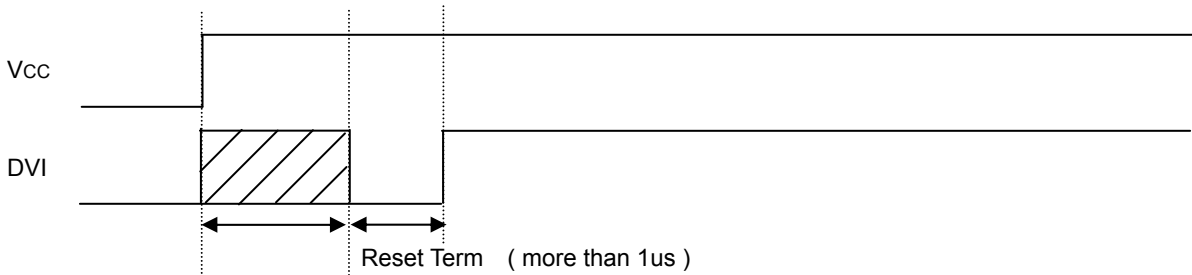

Don't care state

ADDR, SDA, SCL is not stable if DVI 'L' term (1us) is not given by systems.

In this case, please connect the resistors (approximately 100kOhm) to ADDR without directly connecting to VCC or GND, because it is 3 state buffer for Internal testing.

●Measurement sequence example from "Write instruction" to "Read measurement result"

ex1) Continuously H-resolution mode (ADDR = 'L')



from Master to Slave



from Slave to Master

① Send "Continuously H-resolution mode " instruction

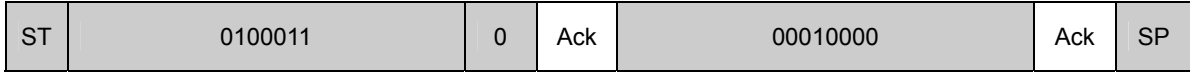

② Wait to complete 1st H-resolution mode measurement.(max. 180ms.)

③ Read measurement result.

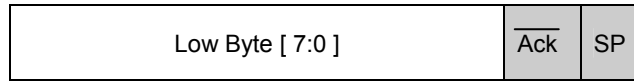

How to calculate when the data High Byte is "10000011" and Low Byte is "10010000"
 $(2^{15} + 2^9 + 2^8 + 2^7 + 2^4) / 1.2 \doteq 28067 [lx]$

The result of continuously measurement mode is updated.(120ms.typ at H-resolution mode, 16ms.typ at L-resolution mode)

ex2) One time L-resolution mode (ADDR = 'H')

① Send "One time L-resolution mode " instruction



② Wait to complete L-resolution mode measurement.(max. 24ms.)

③ Read measurement result

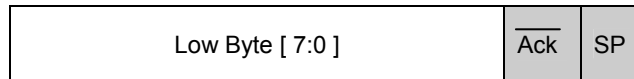
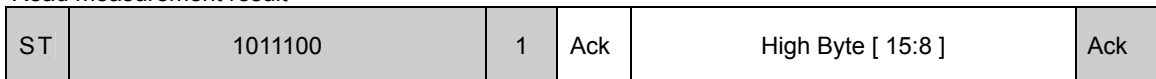

How to calculate when the data High Byte is "00000001" and Low Byte is "00010000"
 $(2^8 + 2^4) / 1.2 \doteq 227 [lx]$

In one time measurement, Statement moves to power down mode after measurement completion.If updated result is need then please resend measurement instruction.

●Application circuit example of DVI terminal

The DVI terminal is an asynchronous reset terminal. Please note that there is a possibility that IC doesn't operate normally if the reset section is not installed after the start-up of Vcc.

(Please refer to the paragraph of "Timing chart for Vcc and DVI power supply sequence")

The description concerning SDA and the terminal SCL is omitted in this application circuit example. Please design the application the standard of the I2C bus as it finishes being satisfactory. Moreover, the description concerning the terminal ADDR is omitted. Please refer to the paragraph of "Timing chart for Vcc and DVI power supply sequence" about the terminal ADDR design.

ex 1) The control signal line such as CPU is connected.

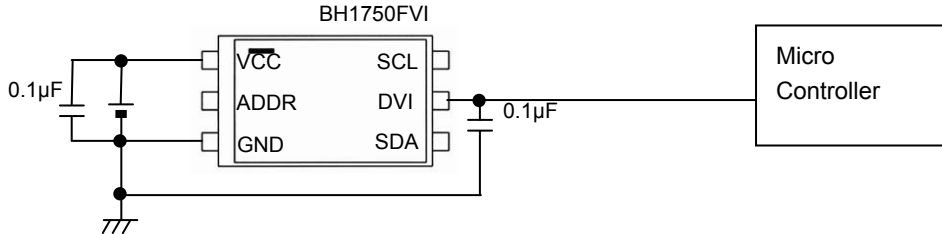

ex 2) Reset IC is used.

1, For Reset IC of the Push-Pull type

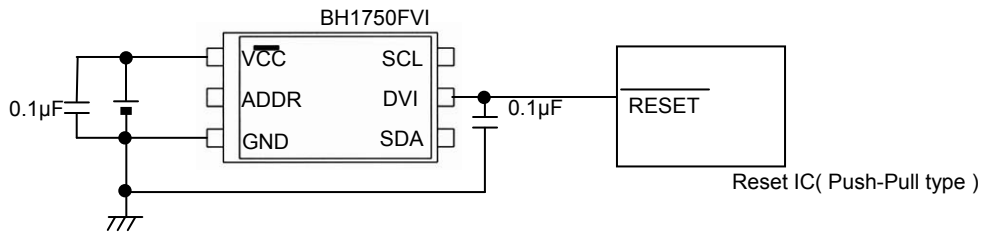

2, For Reset IC of the Open drain output

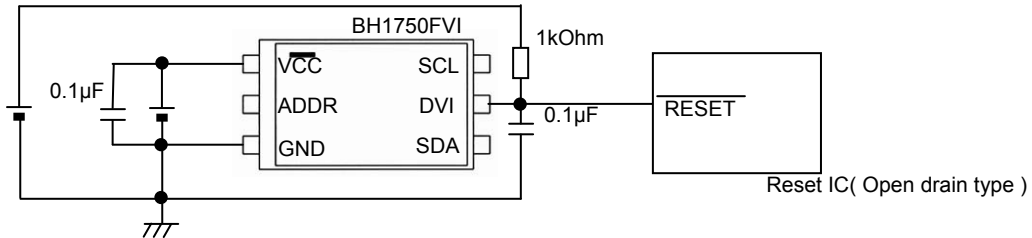

ex 3) A different power supply is used.

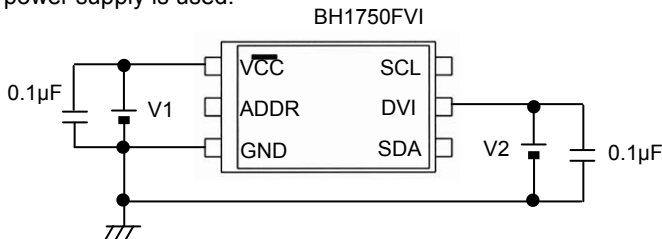

※ Power supply of DVI must stand up later than power supply of VCC stand up, because it is necessary to secure reset section (1µs or more).

ex 4) LPF using CR is inserted between VCC and DVI.

This method has the possibility that the Reset section of turning on the power supply can not satisfied. cannot be satisfied. Please design the set considering the characteristic of the power supply enough.

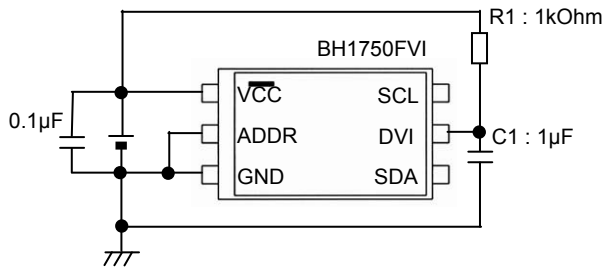

◆ Notes when CR is inserted between VCC and DVI

- ※ Please note that there is a possibility that reset section (1µs) can not be satisfied because the power supply is turned on when the rise time of VCC is slow
- ※ When VCC is turned off, the DVI voltage becomes higher than VCC voltage but IC destruction is not occred if recommended constant (R1 = 1kOhm, C1 = 1µF) is used.
- ※ Please note that there is a possibility that Reset section (1µsec) cannot be satisfied if wait time is not enough long after turning off VCC. (It is necessary to consider DVI voltage level after turning off VCC.)

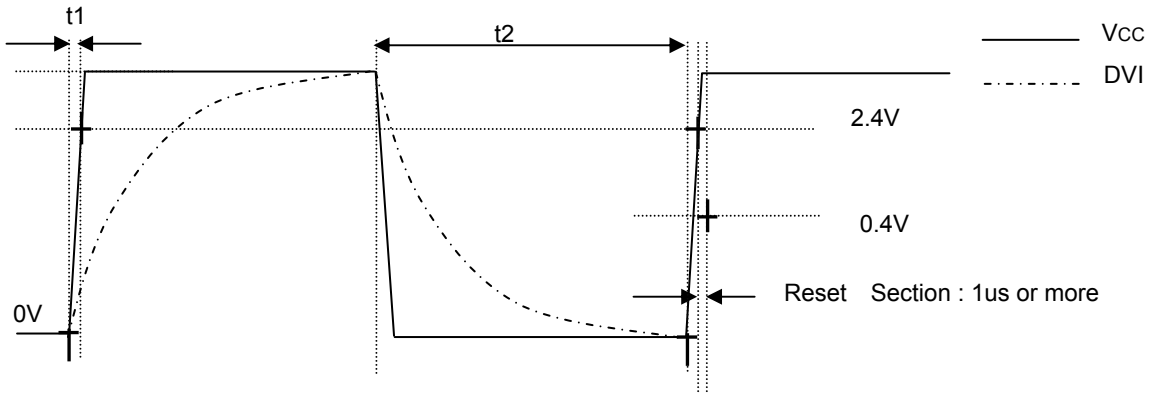

• Please do the application design to secure Reset section 1us or more after the reclosing of the power supply.

◆ Example of designing set when CR (C = 1µF, R = 1kΩ) is inserted between VCC and DVI with VCC=2.8V

- ①The rise time to 0→2.4V of VCC must use the power supply of 100µs or less.
- ②Please wait 25ms or more after VCC turn off (VCC <= 0.05V), because it is necessary to secure reset section (1µs or more).

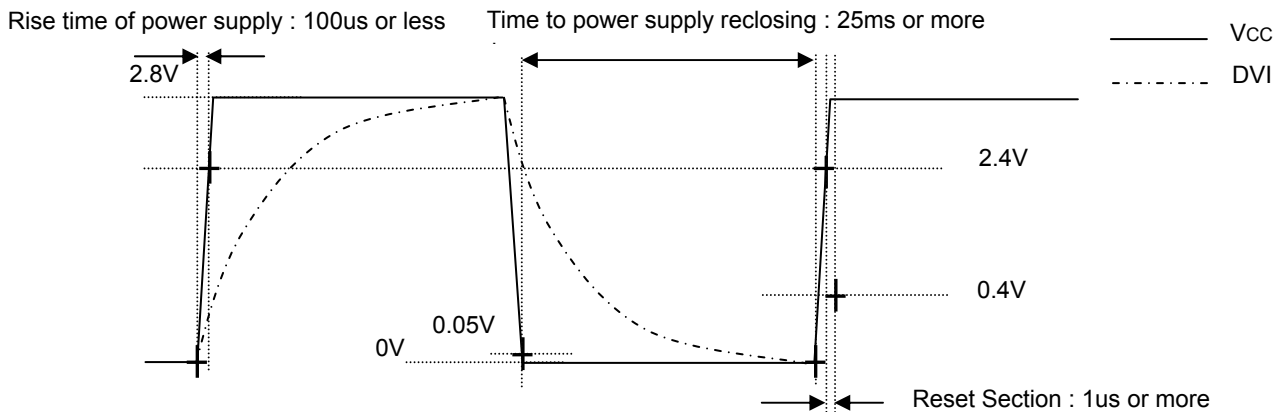

• Please do the application design to secure Reset section 1us or more after the reclosing of the power supply.

● I²C Bus Access

1) I²C Bus Interface Timing chart

Write measurement command and Read measurement result are done by I²C Bus interface. Please refer the formally specification of I²C Bus interface, and follow the formally timing chart.

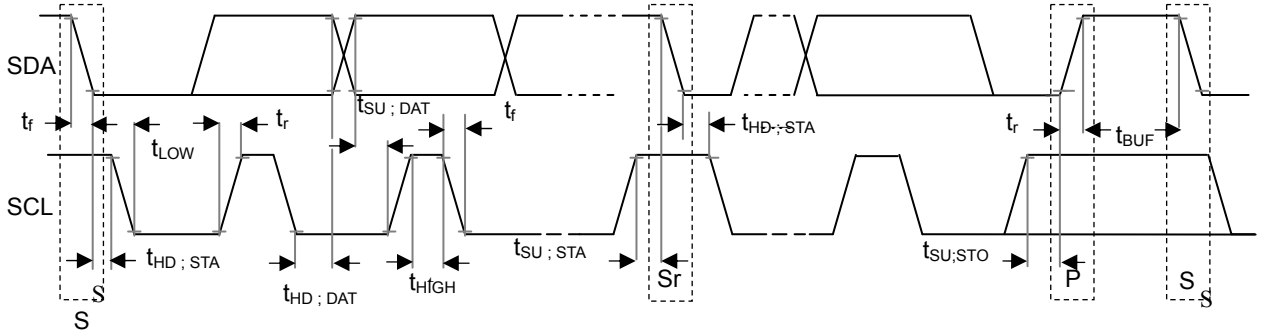

2) Slave Address

Slave Address is 2 types, it is determined by ADDR Terminal

- ADDR = 'H' (ADDR \geq 0.7VCC) → "1011100"
- ADDR = 'L' (ADDR \leq 0.3VCC) → "0100011"

3) Write Format

BH1750FVI is not able to accept plural command without stop condition. Please insert SP every 1 Opcode.

ST	Slave Address	R/W 0	Ack	Opcode	Ack	SP
----	---------------	----------	-----	--------	-----	----

4) Read Format

ST	Slave Address	R/W 1	Ack	High Byte [15:8] $2^{15} \ 2^{14} \ 2^{13} \ 2^{12} \ 2^{11} \ 2^{10} \ 2^9 \ 2^8$	Ack
----	---------------	----------	-----	---	-----

$2^7 \ 2^6 \ 2^5 \ 2^4 \ 2^3 \ 2^2 \ 2^1 \ 2^0$	Low Byte [7:0]	$\overline{\text{Ack}}$	SP
---	----------------	-------------------------	----



from Master to Slave



from Slave to Master

ex)

High Byte = "1000_0011"
 Low Byte = "1001_0000"
 $(2^{15} + 2^9 + 2^8 + 2^7 + 2^4) / 1.2 \doteq 28067 [lx]$

* I²C BUS is trademark of Phillips Semiconductors. Please refer formality specification.

●Adjust measurement result for influence of optical window. (sensor sensitivity adjusting)

BH1750FVI is possible to change sensor sensitivity. And it is possible to cancel the optical window influence (difference with / without optical window) by using this function. Adjust is done by changing measurement time. For example, when transmission rate of optical window is 50% (measurement result becomes 0.5 times if optical window is set), influence of optical window is ignored by changing sensor sensitivity from default to 2 times

Sensor sensitivity is shift by changing the value of MTreg (measurement time register). MTreg value has to set 2 times if target of sensor sensitivity is 2 times. Measurement time is also set 2 times when MTreg value is changed from default to 2 times.

ex) Procedure for changing target sensor sensitivity to 2 times.

Please change Mtrege from "0100_0101" (default) to "1000_1010" (default * 2).

1) Changing High bit of MTreg

ST	Slave Address	R/W 0	Ack	01000_100	Ack	SP
----	---------------	----------	-----	-----------	-----	----

2) Changing Low bit of MTreg

ST	Slave Address	R/W 0	Ack	011_01010	Ack	SP
----	---------------	----------	-----	-----------	-----	----

3) Input Measurement Command

ST	Slave Address	R/W 0	Ack	0001_0000	Ack	SP
----	---------------	----------	-----	-----------	-----	----

* This example is High Resolution mode, but it accepts the other measurement.

4) After about 240ms, measurement result is registered to Data Register.
(High Resolution mode is typically 120ms, but measurement time is set twice.)

The below table is seeing the changeable range of MTreg.

		Min.	Typ.	Max.
changeable range of MTreg	binary	0001_1111 (sensitivity : default * 0.45)	0100_0101 default	1111_1110 (sensitivity : default * 3.68)
	decimal	31 (sensitivity : default * 0.45)	69 default	254 (sensitivity : default * 3.68)

It is possible to detect 0.23lx by using this function at H-resolution mode. And it is possible to detect 0.11lx by using this function at H-resolution mode2.

The below formula is to calculate illuminance per 1 count.

H-resolution mode : Illuminance per 1 count (lx / count) = 1 / 1.2 * (69 / X)

H-resolution mode2 : Illuminance per 1 count (lx / count) = 1 / 1.2 * (69 / X) / 2

1.2 : Measurement accuracy

69 : Default value of MTreg (dec)

X : MTreg value

The below table is seeing the detail of resolution.

Mtreg の値	lx / count at H-resolution mode	lx / count at H-resolution mode2
0001_1111	1.85	0.93
0100_0101	0.83	0.42
1111_1110	0.23	0.11

●H-Resolution Mode2

H-resolution mode2 is 0.5lx (typ.) resolution mode. It is suitable if under less than 10 lx measurement data is necessary. This measurement mode supports " Adjust measurement result for influence of optical window ". Please refer it. It is possible to detect min. 0.11 lx by using H-resolution mode2.

○ Instruction set architecture for H-resolution mode2

Instruction	Opecode	Comments
Continuously H-Resolution Mode2	0001_0001	Start measurement at 0.5lx resolution. Measurement Time is typically 120ms.
One Time H-Resolution Mode2	0010_0001	Start measurement at 0.5lx resolution. Measurement Time is typically 120ms. It is automatically set to Power Down mode after measurement.

○ Measurement sequence example from "Write instruction" to "Read measurement result"

ex) Continuously H-resolution mode2 (ADDR = 'L')



① Send "Continuously H-resolution mode2 " instruction

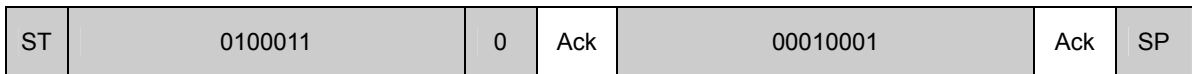

② Wait to complete 1st H-resolution mode2 measurement.(max. 180ms.)

③ Read measurement result.

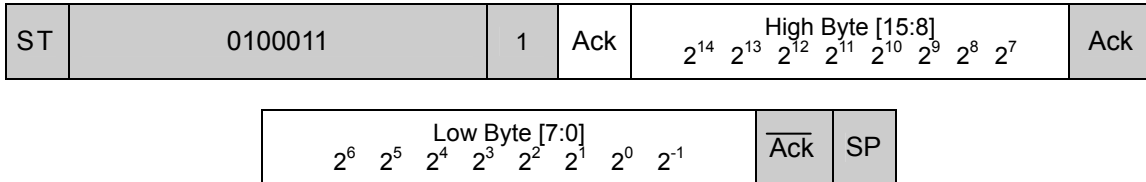

How to calculate when the data High Byte is "00000000" and Low Byte is "00010010"

$$(2^3 + 2^0) / 1.2 \doteq 7.5 [lx]$$

●Terminal Description

PIN No.	Terminal Name	Equivalent Circuit	Function
1	VCC		Power Supply Terminal
2	ADDR		<p>I²C Slave-address Terminal</p> <p>ADDR = 'H' (ADDR ≥ 0.7Vcc) "1011100" ADDR = 'L' (ADDR ≤ 0.3Vcc) "0100011"</p> <p>ADDR Terminal is designed as 3 state buffer for internal test. So that please take care of Vcc and DVI supply procedure. Please see P6.</p>
3	GND		GND Terminal
4	SDA		I ² C bus Interface SDA Terminal
5	DVI		<p>SDA, SCL Reference Voltage Terminal</p> <p>And DVI Terminal is also asynchronous Reset for internal registers. So that please set to 'L' (at least 1μs, DVI ≤ 0.4V) after Vcc is supplied. BH1750FVI is pulled down by 150kOhm while DVI = 'L'.</p>
6	SCL		I ² C bus Interface SCL Terminal

※These values are design-value, not guaranteed.

●Package Outlines

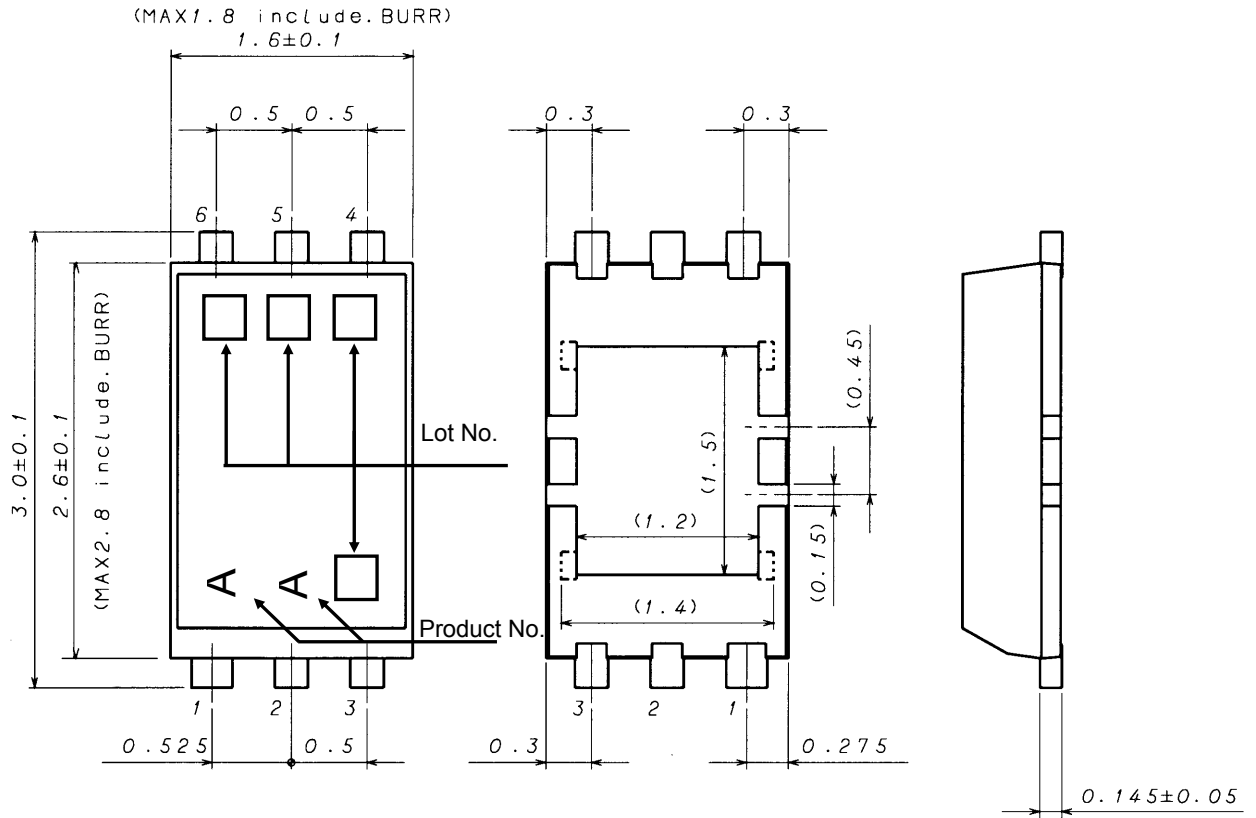

WSOF6I (Unit : mm)

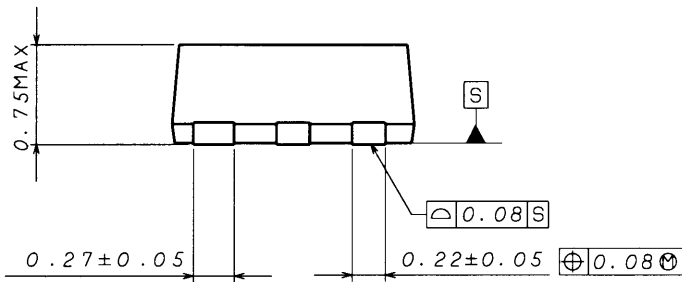

●About an optical design on the device

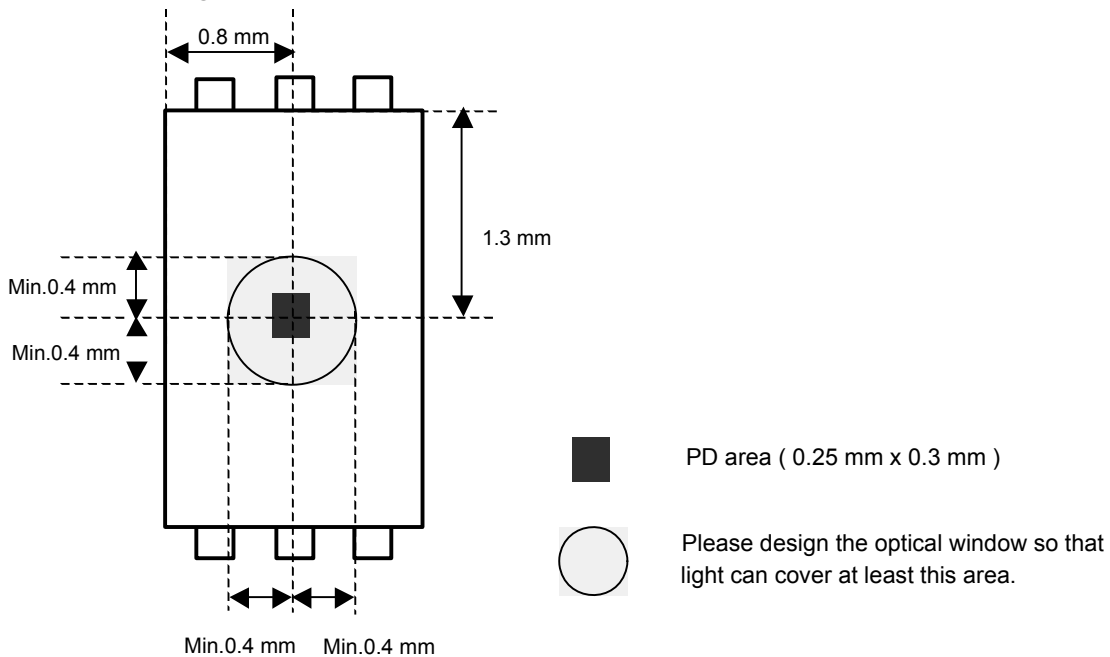

●The method of distinguishing 1pin.

There is some method of distinguishing 1pin.

- ① Distinguishing by 1Pin wide-lead
- ② Distinguishing by die pattern
- ③ Distinguishing by taper part of 1-3pin side

② (by die pattern) is the easiest method to distinguish by naked eye.

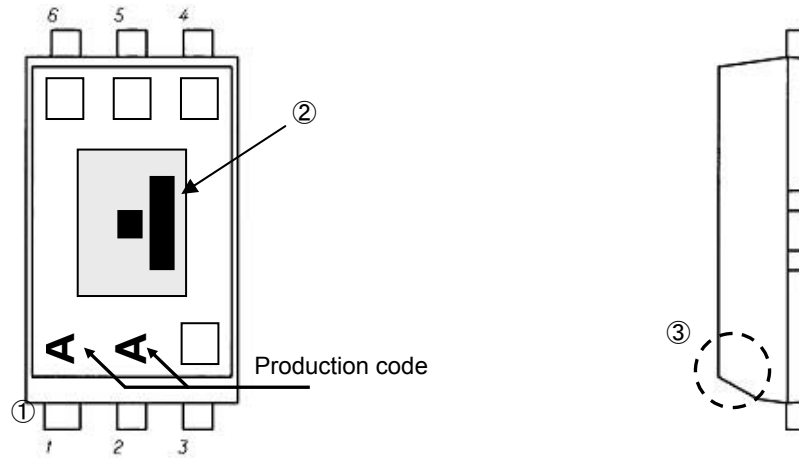

●Cautions on use

1) Absolute Maximum Ratings

An excess in the absolute maximum ratings, such as supply voltage (V_{max}), temperature range of operating conditions (T_{opr}), etc., can break down devices, thus making impossible to identify breaking mode such as a short circuit or an open circuit. If any special mode exceeding the absolute maximum ratings is assumed, consideration should be given to take physical safety measures including the use of fuses, etc.

2) GND voltage

Make setting of the potential of the GND terminal so that it will be maintained at the minimum in any operating state. Furthermore, check to be sure no terminals are at a potential lower than the GND voltage including an actual electric transient.

3) Short circuit between terminals and erroneous mounting

In order to mount ICs on a set PCB, pay thorough attention to the direction and offset of the ICs. Erroneous mounting can break down the ICs. Furthermore, if a short circuit occurs due to foreign matters entering between terminals or between the terminal and the power supply or the GND terminal, the ICs can break down.

4) Operation in strong electromagnetic field

Be noted that using ICs in the strong electromagnetic field can malfunction them.

5) Inspection with set PCB

On the inspection with the set PCB, if a capacitor is connected to a low-impedance IC terminal, the IC can suffer stress. Therefore, be sure to discharge from the set PCB by each process. Furthermore, in order to mount or dismount the set PCB to/from the jig for the inspection process, be sure to turn OFF the power supply and then mount the set PCB to the jig. After the completion of the inspection, be sure to turn OFF the power supply and then dismount it from the jig. In addition, for protection against static electricity, establish a ground for the assembly process and pay thorough attention to the transportation and the storage of the set PCB.

6) Input terminals

In terms of the construction of IC, parasitic elements are inevitably formed in relation to potential. The operation of the parasitic element can cause interference with circuit operation, thus resulting in a malfunction and then breakdown of the input terminal. Therefore, pay thorough attention not to handle the input terminals; such as to apply to the input terminals a voltage lower than the GND respectively, so that any parasitic element will operate. Furthermore, do not apply a voltage to the input terminals when no power supply voltage is applied to the IC. In addition, even if the power supply voltage is applied, apply to the input terminals a voltage lower than the power supply voltage or within the guaranteed value of electrical characteristics.

7) Thermal design

Perform thermal design in which there are adequate margins by taking into account the power dissipation (P_d) in actual states of use.

8) Treatment of package

Dusts or scratch on the photo detector may affect the optical characteristics. Please handle it with care.

9) Rush current

When power is first supplied to the CMOS IC, it is possible that the internal logic may be unstable and rush current may flow instantaneously. Therefore, give special consideration to power coupling capacitance, power wiring, width of GND wiring, and routing of connections.

10) The exposed central pad on the back side of the package

There is an exposed central pad on the back side of the package. But please do it non connection. (Don't solder, and don't do electrical connection) Please mount by Footprint dimensions described in the Jisso Information for WSOF6I. This pad is GND level, therefore there is a possibility that LSI malfunctions and heavy-current is generated.

●Ordering part number

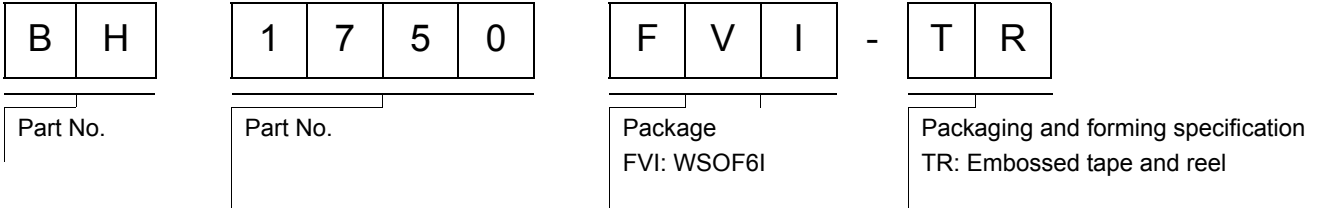

WSOF6I

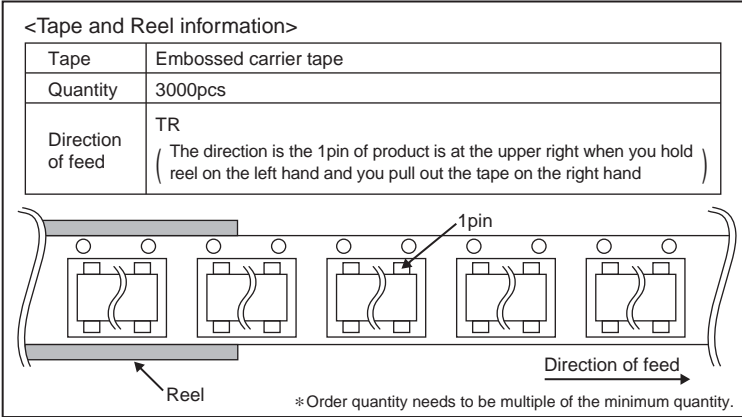
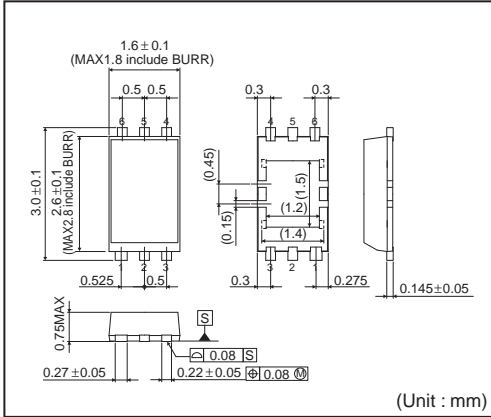

Notice

Precaution on using ROHM Products

- Our Products are designed and manufactured for application in ordinary electronic equipments (such as AV equipment, OA equipment, telecommunication equipment, home electronic appliances, amusement equipment, etc.). If you intend to use our Products in devices requiring extremely high reliability (such as medical equipment ^(Note 1), transport equipment, traffic equipment, aircraft/spacecraft, nuclear power controllers, fuel controllers, car equipment including car accessories, safety devices, etc.) and whose malfunction or failure may cause loss of human life, bodily injury or serious damage to property ("Specific Applications"), please consult with the ROHM sales representative in advance. Unless otherwise agreed in writing by ROHM in advance, ROHM shall not be in any way responsible or liable for any damages, expenses or losses incurred by you or third parties arising from the use of any ROHM's Products for Specific Applications.

(Note1) Medical Equipment Classification of the Specific Applications

JAPAN	USA	EU	CHINA
CLASS III	CLASS III	CLASS II b	CLASS III
CLASS IV		CLASS III	

- ROHM designs and manufactures its Products subject to strict quality control system. However, semiconductor products can fail or malfunction at a certain rate. Please be sure to implement, at your own responsibilities, adequate safety measures including but not limited to fail-safe design against the physical injury, damage to any property, which a failure or malfunction of our Products may cause. The following are examples of safety measures:
 - Installation of protection circuits or other protective devices to improve system safety
 - Installation of redundant circuits to reduce the impact of single or multiple circuit failure
- Our Products are designed and manufactured for use under standard conditions and not under any special or extraordinary environments or conditions, as exemplified below. Accordingly, ROHM shall not be in any way responsible or liable for any damages, expenses or losses arising from the use of any ROHM's Products under any special or extraordinary environments or conditions. If you intend to use our Products under any special or extraordinary environments or conditions (as exemplified below), your independent verification and confirmation of product performance, reliability, etc. prior to use, must be necessary:
 - Use of our Products in any types of liquid, including water, oils, chemicals, and organic solvents
 - Use of our Products outdoors or in places where the Products are exposed to direct sunlight or dust
 - Use of our Products in places where the Products are exposed to sea wind or corrosive gases, including Cl₂, H₂S, NH₃, SO₂, and NO₂
 - Use of our Products in places where the Products are exposed to static electricity or electromagnetic waves
 - Use of our Products in proximity to heat-producing components, plastic cords, or other flammable items
 - Sealing or coating our Products with resin or other coating materials
 - Use of our Products without cleaning residue of flux (even if you use no-clean type fluxes, cleaning residue of flux is recommended); or Washing our Products by using water or water-soluble cleaning agents for cleaning residue after soldering
 - Use of the Products in places subject to dew condensation
- The Products are not subject to radiation-proof design.
- Please verify and confirm characteristics of the final or mounted products in using the Products.
- In particular, if a transient load (a large amount of load applied in a short period of time, such as pulse. is applied, confirmation of performance characteristics after on-board mounting is strongly recommended. Avoid applying power exceeding normal rated power; exceeding the power rating under steady-state loading condition may negatively affect product performance and reliability.
- De-rate Power Dissipation (Pd) depending on Ambient temperature (Ta). When used in sealed area, confirm the actual ambient temperature.
- Confirm that operation temperature is within the specified range described in the product specification.
- ROHM shall not be in any way responsible or liable for failure induced under deviant condition from what is defined in this document.

Precaution for Mounting / Circuit board design

- When a highly active halogenous (chlorine, bromine, etc.) flux is used, the residue of flux may negatively affect product performance and reliability.
- In principle, the reflow soldering method must be used; if flow soldering method is preferred, please consult with the ROHM representative in advance.

For details, please refer to ROHM Mounting specification

Precautions Regarding Application Examples and External Circuits

1. If change is made to the constant of an external circuit, please allow a sufficient margin considering variations of the characteristics of the Products and external components, including transient characteristics, as well as static characteristics.
2. You agree that application notes, reference designs, and associated data and information contained in this document are presented only as guidance for Products use. Therefore, in case you use such information, you are solely responsible for it and you must exercise your own independent verification and judgment in the use of such information contained in this document. ROHM shall not be in any way responsible or liable for any damages, expenses or losses incurred by you or third parties arising from the use of such information.

Precaution for Electrostatic

This Product is electrostatic sensitive product, which may be damaged due to electrostatic discharge. Please take proper caution in your manufacturing process and storage so that voltage exceeding the Products maximum rating will not be applied to Products. Please take special care under dry condition (e.g. Grounding of human body / equipment / solder iron, isolation from charged objects, setting of ionizer, friction prevention and temperature / humidity control).

Precaution for Storage / Transportation

1. Product performance and soldered connections may deteriorate if the Products are stored in the places where:
 - [a] the Products are exposed to sea winds or corrosive gases, including Cl₂, H₂S, NH₃, SO₂, and NO₂
 - [b] the temperature or humidity exceeds those recommended by ROHM
 - [c] the Products are exposed to direct sunshine or condensation
 - [d] the Products are exposed to high Electrostatic
2. Even under ROHM recommended storage condition, solderability of products out of recommended storage time period may be degraded. It is strongly recommended to confirm solderability before using Products of which storage time is exceeding the recommended storage time period.
3. Store / transport cartons in the correct direction, which is indicated on a carton with a symbol. Otherwise bent leads may occur due to excessive stress applied when dropping of a carton.
4. Use Products within the specified time after opening a humidity barrier bag. Baking is required before using Products of which storage time is exceeding the recommended storage time period.

Precaution for Product Label

QR code printed on ROHM Products label is for ROHM's internal use only.

Precaution for Disposition

When disposing Products please dispose them properly using an authorized industry waste company.

Precaution for Foreign Exchange and Foreign Trade act

Since our Products might fall under controlled goods prescribed by the applicable foreign exchange and foreign trade act, please consult with ROHM representative in case of export.

Precaution Regarding Intellectual Property Rights

1. All information and data including but not limited to application example contained in this document is for reference only. ROHM does not warrant that foregoing information or data will not infringe any intellectual property rights or any other rights of any third party regarding such information or data. ROHM shall not be in any way responsible or liable for infringement of any intellectual property rights or other damages arising from use of such information or data.:
2. No license, expressly or implied, is granted hereby under any intellectual property rights or other rights of ROHM or any third parties with respect to the information contained in this document.

Other Precaution

1. This document may not be reprinted or reproduced, in whole or in part, without prior written consent of ROHM.
2. The Products may not be disassembled, converted, modified, reproduced or otherwise changed without prior written consent of ROHM.
3. In no event shall you use in any way whatsoever the Products and the related technical information contained in the Products or this document for any military purposes, including but not limited to, the development of mass-destruction weapons.
4. The proper names of companies or products described in this document are trademarks or registered trademarks of ROHM, its affiliated companies or third parties.

General Precaution

1. Before you use our Products, you are requested to carefully read this document and fully understand its contents. ROHM shall not be in any way responsible or liable for failure, malfunction or accident arising from the use of any ROHM's Products against warning, caution or note contained in this document.
2. All information contained in this document is current as of the issuing date and subject to change without any prior notice. Before purchasing or using ROHM's Products, please confirm the latest information with a ROHM sales representative.
3. The information contained in this document is provided on an "as is" basis and ROHM does not warrant that all information contained in this document is accurate and/or error-free. ROHM shall not be in any way responsible or liable for any damages, expenses or losses incurred by you or third parties resulting from inaccuracy or errors of or concerning such information.

Mouser Electronics

Authorized Distributor

Click to View Pricing, Inventory, Delivery & Lifecycle Information:

[ROHM Semiconductor:](#)

[BH1750FVI-TR](#)