

Series: ARMADILLO

Description: Vehicular Multiband Antenna with Direct Mount

PART NUMBER: ARMXXXXDM



Features:

- Low profile, only 1.8” tall
- Up to 6-lead Configuration
 - LTE(2x) MIMO
 - WiFi(3x) MIMO-|2.4/5.x GHz
 - GPS/GNSS (1x)
- Frequency of Operation:
 - 698-960MHz,1710-2690MHz
 - 2400-2500MHz,5150-5925MHz
 - 1559-1606MHz

Applications:

- Telematics, Navigation
- First Responders(Police, Fire, Ambulance/EMS)
- Energy, Utility, Construction
- Fleet Management
- DSRC(Dedicated Short Range Communications)
- Available Configurations:
 - Black, White
 - Direct, Magnetic, Adhes.Mount

Issue: 2034

In the effort to improve our products, we reserve the right to make changes judged to be necessary.

CONFIDENTIAL AND PROPRIETARY INFORMATION

This document contains confidential and proprietary information of Pulse Electronics, Inc. (Pulse) and is protected by copyright, trade secret and other state and federal laws. Its receipt or possession does not convey any rights to reproduce, disclose its contents, or to manufacture, use or sell anything it may describe. Reproduction, disclosure or use without specific written authorization of Pulse is strictly forbidden.

For more information:

Pulse Worldwide Headquarters
15255 Innovation Drive #100
San Diego, CA 92128
USA
Tel:1-858-674-8100

Pulse/Larsen Antennas
18110 SE 34th St Bldg 2 Suite 250
Vancouver, WA 98683
USA
Tel: 1-360-944-7551

Europe Headquarters
Pulse GmbH & Do, KG
Zeppelinstrasse 15
Herrenberg, Germany
Tel: 49 7032 7806 0

Pulse (Suzhou) Wireless Products Co, Inc.
99 Huo Ju Road(#29 Bldg,4th Phase
Suzhou New District
Jiangsu Province, Suzhou 215009 PR China
Tel: 86 512 6807 9998



Series: ARMADILLO

Description: Vehicular Multiband Antenna with Direct Mount

PART NUMBER: ARMXXXXDM

This document covers all product variants of the following product family

Product	Total Cable Leads	LTE Cable Leads	WiFi Cable Leads	GPS Cable Leads	Housing Color	Cable Length	Mounting
ARM62311DM	6	2 (with SMA Male)	3 (with RP-SMA Male)	1 (with SMA Male)	Black	17 FT or 5181mm	1. Direct Mount; 7/8" Hole Required 2. Mounting Surface thickness < 0.25"
ARM62312DM	6	2 (with SMA Male)	3 (with RP-SMA Male)	1 (with SMA Male)	White		
ARM52211DM	5	2 (with SMA Male)	2 (with RP-SMA Male)	1 (with SMA Male)	Black		
ARM52212DM	5	2 (with SMA Male)	2 (with RP-SMA Male)	1 (with SMA Male)	White		
ARM42111DM	4	2 (with SMA Male)	1 (with RP-SMA Male)	1 (with SMA Male)	Black		
ARM42112DM	4	2 (with SMA Male)	1 (with RP-SMA Male)	1 (with SMA Male)	White		
ARM32011DM	3	2 (with SMA Male)	0	1 (with SMA Male)	Black		
ARM32012DM	3	2 (with SMA Male)	0	1 (with SMA Male)	White		
ARM21011DM	2	1 (with SMA Male)	0	1 (with SMA Male)	Black		
ARM21012DM	2	1 (with SMA Male)	0	1 (with SMA Male)	White		
ARM21011DMTT	2	1 (with TNC Male)	0	1 (with TNC Male)	Black		
ARM22001DM	2	2 (with SMA Male)	0	0	Black		

Issue: 2034

In the effort to improve our products, we reserve the right to make changes judged to be necessary.

CONFIDENTIAL AND PROPRIETARY INFORMATION

This document contains confidential and proprietary information of Pulse Electronics, Inc. (Pulse) and is protected by copyright, trade secret and other state and federal laws. Its receipt or possession does not convey any rights to reproduce, disclose its contents, or to manufacture, use or sell anything it may describe. Reproduction, disclosure or use without specific written authorization of Pulse is strictly forbidden.

For more information:

Pulse Worldwide Headquarters
15255 Innovation Drive #100
San Diego, CA 92128
USA
Tel: 1-858-674-8100

Pulse/Larsen Antennas
18110 SE 34th St Bldg 2 Suite 250
Vancouver, WA 98683
USA
Tel: 1-360-944-7551

Europe Headquarters
Pulse GmbH & Do, KG
Zeppelinstrasse 15
Herrenberg, Germany
Tel: 49 7032 7806 0

Pulse (Suzhou) Wireless Products Co, Inc.
99 Huo Ju Road(#29 Bldg,4th Phase
Suzhou New District
Jiangsu Province, Suzhou 215009 PR China
Tel: 86 512 6807 9998



Description: Vehicular Multiband Antenna with Direct Mount

Series: ARMADILLO

PART NUMBER: ARMXXXXDM

This document covers all product variants of the following product family

Product Numbering

Vehicular Multiband Antenna with Direct Mount



①	Product ID: ARMADILLO
②	Total Number of Cable leads
③	Total Number of LTE Cable Leads
④	Total Number of WiFi Cable Leads
⑤	Total Number of GPS Cable Leads
⑥	The Color of the Plastic Housing 1=Black; 2= White
⑦	Mounting: Direct Mount; 7/8" Hole Required

Issue: 2034

In the effort to improve our products, we reserve the right to make changes judged to be necessary.

CONFIDENTIAL AND PROPRIETARY INFORMATION

This document contains confidential and proprietary information of Pulse Electronics, Inc. (Pulse) and is protected by copyright, trade secret and other state and federal laws. Its receipt or possession does not convey any rights to reproduce, disclose its contents, or to manufacture, use or sell anything it may describe. Reproduction, disclosure or use without specific written authorization of Pulse is strictly forbidden.

For more information:

Pulse Worldwide Headquarters
15255 Innovation Drive #100
San Diego, CA 92128
USA
Tel: 1-858-674-8100

Pulse/Larsen Antennas
18110 SE 34th St Bldg 2 Suite 250
Vancouver, WA 98683
USA
Tel: 1-360-944-7551

Europe Headquarters
Pulse GmbH & Do, KG
Zeppelinstrasse 15
Herrenberg, Germany
Tel: 49 7032 7806 0

Pulse (Suzhou) Wireless Products Co, Inc.
99 Huo Ju Road(#29 Bldg,4th Phase
Suzhou New District
Jiangsu Province, Suzhou 215009 PR China
Tel: 86 512 6807 9998



Description: Vehicular Multiband Antenna with Direct Mount

Series: ARMADILLO

PART NUMBER: ARMXXXXDM

ELECTRICAL SPECIFICATIONS

Frequency	698-960MHz, 1710-2690MHz 2400-2500MHz, 5150-5925MHz
Nominal Impedance	50 Ω
VSWR*	
698-960MHz	<2.5
1710-2690MHz	<2.5
2400-2500MHz	<2
5150-5925MHz	<2
Isolation*	
698-960MHz, 1710-2690MHz	-8dB
2400-2500MHz, 5150-5925MHz	-12dB
Average Peak Gain**	
698-960MHz;	4.9dBi
1710-2690MHz	5.3dBi
2400-2500MHz	4.6dBi
5150-5925MHz	6.6dBi
Polarization	Vertical

*Test on 500mm ground plane with 17ft(5.2m) LMR195 cable

**Test on 500mm ground plane with 1ft(304.8) LMR195 cable

Description: Vehicular Multiband Antenna with Direct Mount

Series: ARMADILLO

PART NUMBER: ARMXXXXDM

ELECTRICAL SPECIFICATIONS

GPS Antenna	
Frequency	1561.098±2.046MHz/ 1575.42±1.023MHz/ 1602.5625±4MHz
Nominal Impedance	50 Ω
VSWR	<2
Gain (Radiating Element)	1 dBic±1 dB
Gain (LNA Gain)	30 dB± 2 dB
Polarization	RHCP
Out of Band Rejection	
698 MHz	>70 dB
960 MHz	>65 dB
1710 MHz	>60 dB
2170 MHz	>65 dB
2400 MHz	>65 dB
2700 MHz	>65 dB
Noise Figure	<2.4 dB
Operating Voltage	3.3 – 5 Vdc
Current Consumption	<15mA

Description: Vehicular Multiband Antenna with Direct Mount

Series: ARMADILLO

PART NUMBER: ARMXXXXDM

MECHANICAL SPECIFICATIONS

Overall Length	202.3mm X 88.5mm X 45mm
Weight	1.15 Kg
Antenna Color / Material	Black or White
Connector type	Refer to Page 2
Cable type	Refer to Page 2
Cable length	Refer to Page 2

ENVIRONMENTAL SPECIFICATIONS

Operating Temperature	-40 ~ +85° C
Storage Temperature	-40 ~ +85° C
Ingress Protection	IP67
RoHS Compliant	Yes

OTHER SPECIFICATIONS

Total cable assembly loss for 5.2m (17') LMR-195 @850MHz	2.1dB
Total cable assembly loss for 5.2m (17') LMR-100 @1575MHz	5.9dB
Total cable assembly loss for 5.2m (17') LMR-195 @1930MHz	3.2dB
Total cable assembly loss for 5.2m (17') LMR-195 @2450MHz	3.6dB
Total cable assembly loss for 5.2m (17') LMR-195 @2500MHz	3.7dB
Total cable assembly loss for 5.2m (17') LMR-195 @5350MHz	5.5dB

Description: Vehicular Multiband Antenna with Direct Mount

Series: ARMADILLO

PART NUMBER: ARMXXXXDM

MECHANICAL DRAWING

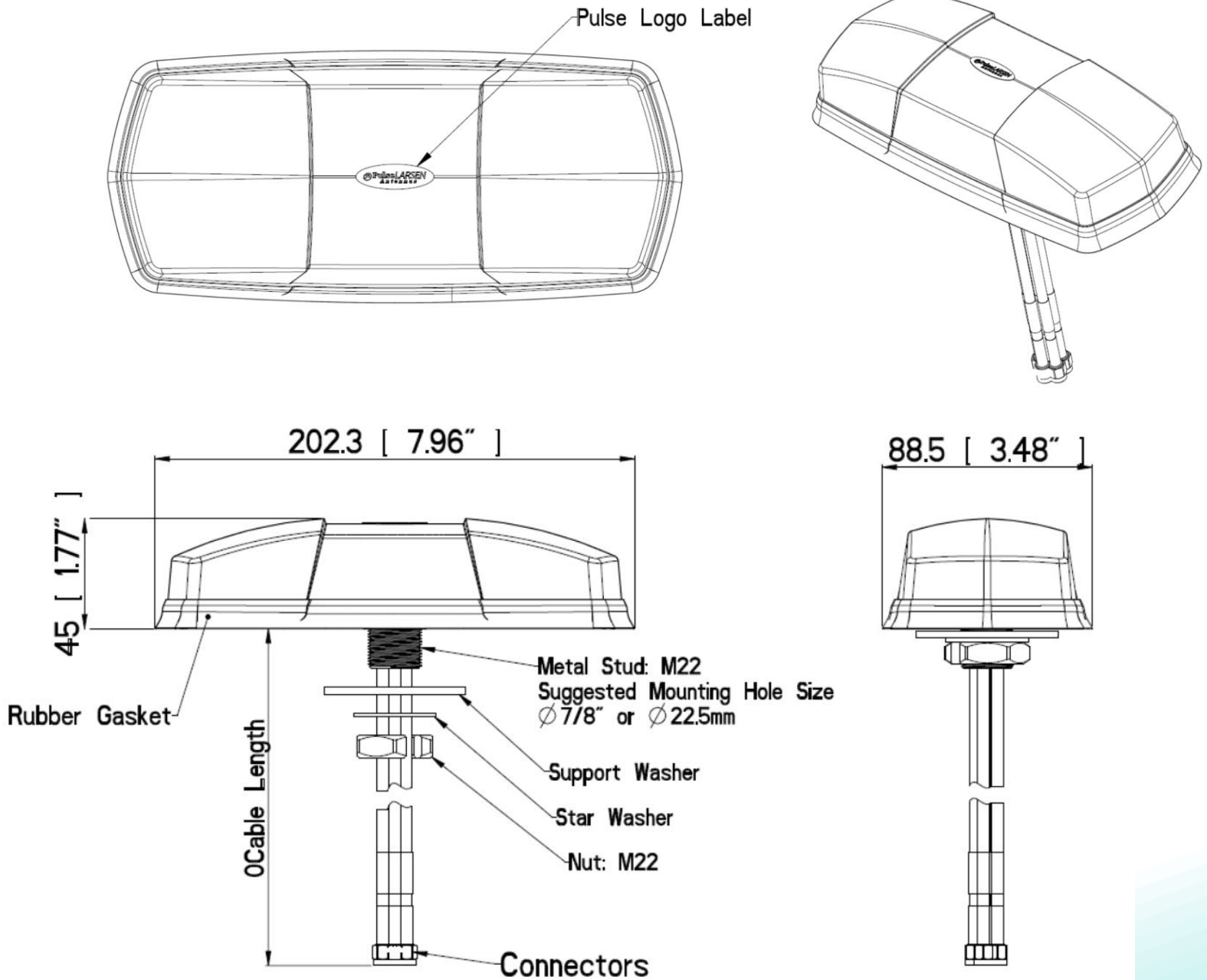

Issue: 2034

In the effort to improve our products, we reserve the right to make changes judged to be necessary.
CONFIDENTIAL AND PROPRIETARY INFORMATION

This document contains confidential and proprietary information of Pulse Electronics, Inc. (Pulse) and is protected by copyright, trade secret and other state and federal laws. Its receipt or possession does not convey any rights to reproduce, disclose its contents, or to manufacture, use or sell anything it may describe. Reproduction, disclosure or use without specific written authorization of Pulse is strictly forbidden.

Description: Vehicular Multiband Antenna with Direct Mount

Series: ARMADILLO

PART NUMBER: ARMXXXXDM

MECHANICAL DRAWING

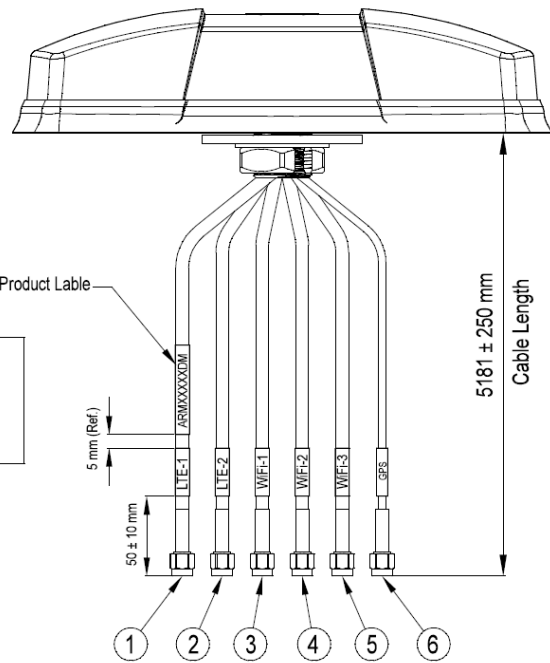

Product Lable Content

P.N.:ARM62311DM
Rev.: V01
Date: DD-MM-YYYY

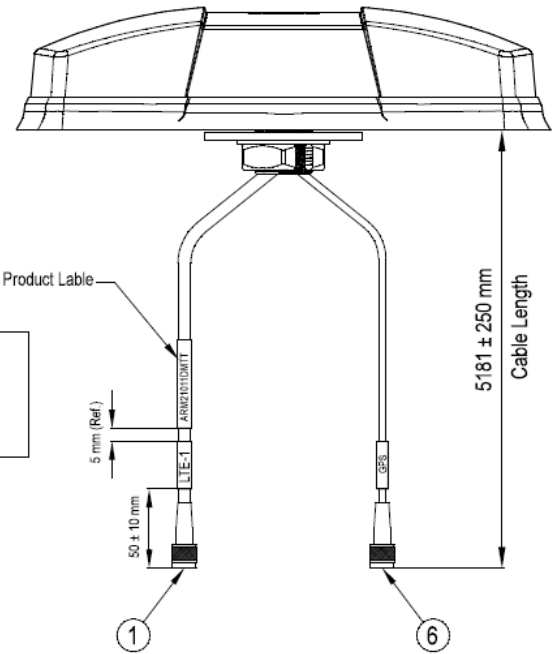

Product Lable Content

P.N.:ARM21011DMTT
Rev.: V01
Date: DD-MM-YYYY

ARM62311DM		CABLE	CABLE LENGTH	CONNECTOR
1	LTE-1 Cable Assy	LMR-195 *	5181 mm / 204" / 17 FT	SMA Male
2	LTE-2 Cable Assy			
3	WiFi-1 Cable Assy			
4	WiFi-2 Cable Assy	LMR-195*		RP-SMA Male
5	WiFi-3 Cable Assy			
6	GPS Cable Assy	LMR-100*		SMA Male

* or equivalent

ARM21011DMTT		CABLE	CABLE LENGTH	CONNECTOR
1	LTE-1 Cable Assy	LMR-195 *	5181 mm / 204" / 17 FT	TNC Male
2				
3				
4				
5				
6	GPS Cable Assy	LMR-100*		TNC Male

* or equivalent

Issue: 2034

In the effort to improve our products, we reserve the right to make changes judged to be necessary.

CONFIDENTIAL AND PROPRIETARY INFORMATION

This document contains confidential and proprietary information of Pulse Electronics, Inc. (Pulse) and is protected by copyright, trade secret and other state and federal laws. Its receipt or possession does not convey any rights to reproduce, disclose its contents, or to manufacture, use or sell anything it may describe. Reproduction, disclosure or use without specific written authorization of Pulse is strictly forbidden.

Series: ARMADILLO

Description: Vehicular Multiband Antenna with Direct Mount

PART NUMBER: ARMXXXXDM

TEST SETUP

Antenna tested on a $\varnothing 500\text{mm}$ ground plane.

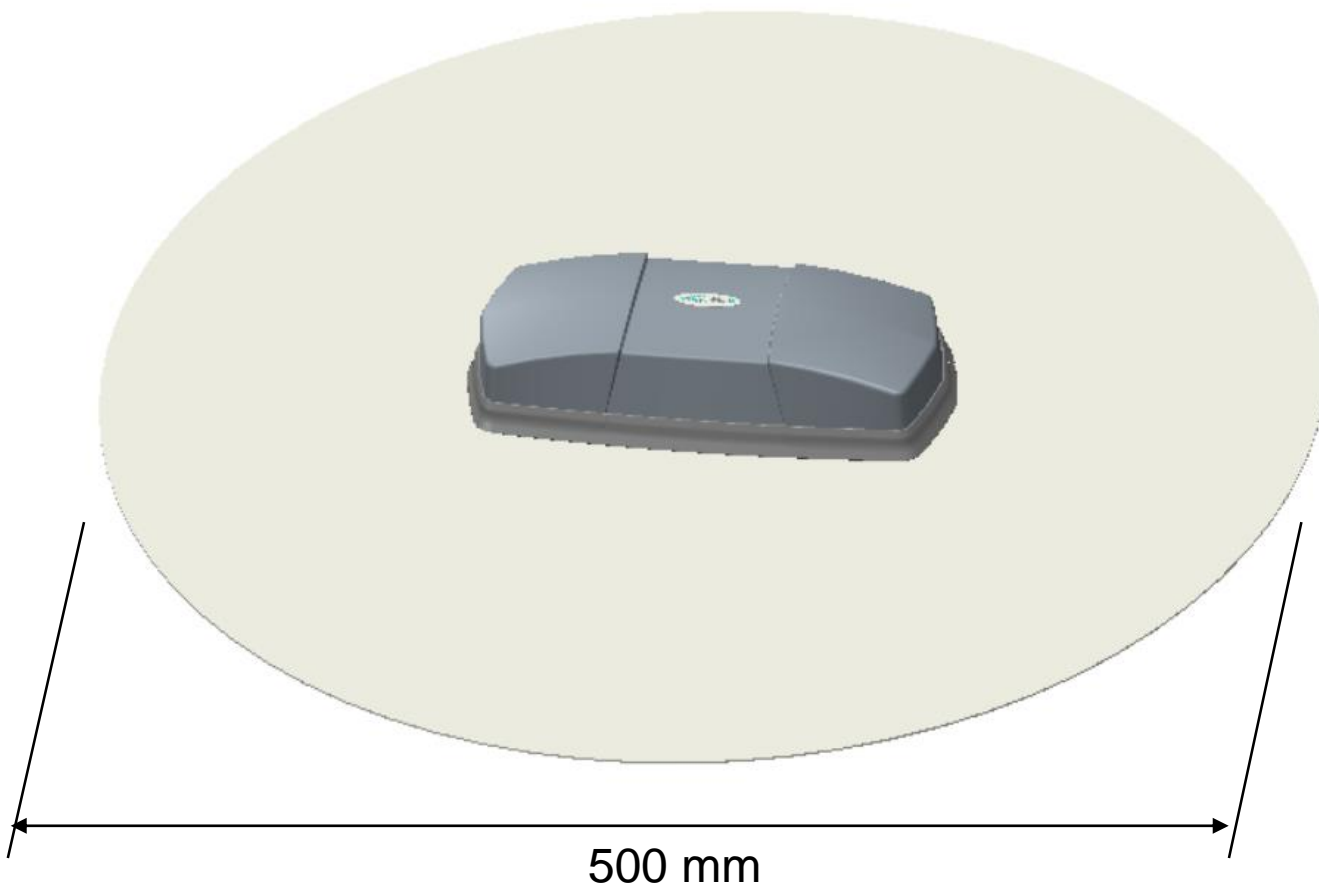

Issue: 2034

In the effort to improve our products, we reserve the right to make changes judged to be necessary.

CONFIDENTIAL AND PROPRIETARY INFORMATION

This document contains confidential and proprietary information of Pulse Electronics, Inc. (Pulse) and is protected by copyright, trade secret and other state and federal laws. Its receipt or possession does not convey any rights to reproduce, disclose its contents, or to manufacture, use or sell anything it may describe. Reproduction, disclosure or use without specific written authorization of Pulse is strictly forbidden.

Description: Vehicular Multiband Antenna with Direct Mount

Series: ARMADILLO

PART NUMBER: ARMXXXXDM

CHARTS

VSWR (LTE)

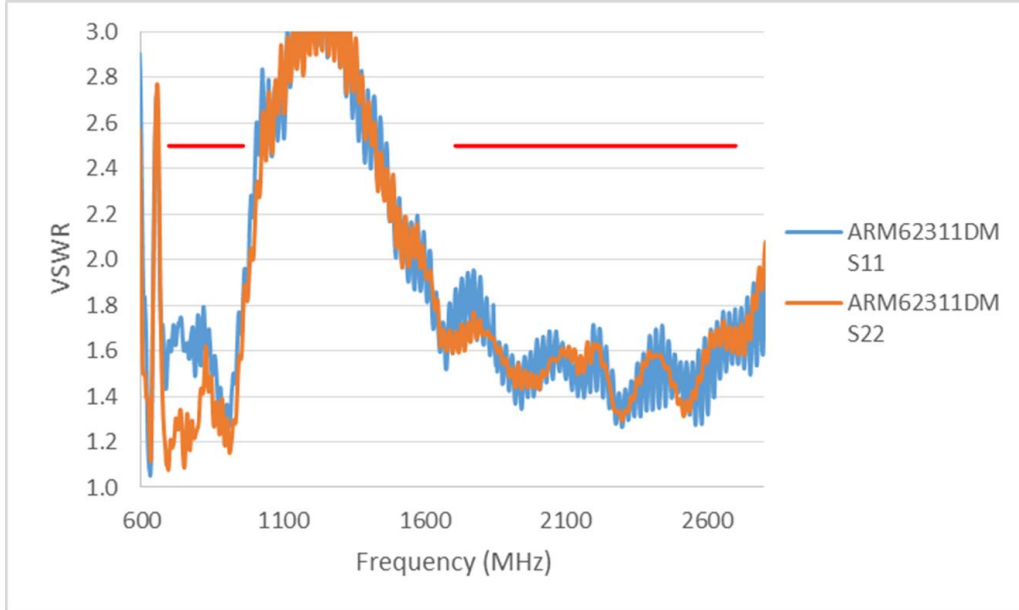

Isolation (LTE)

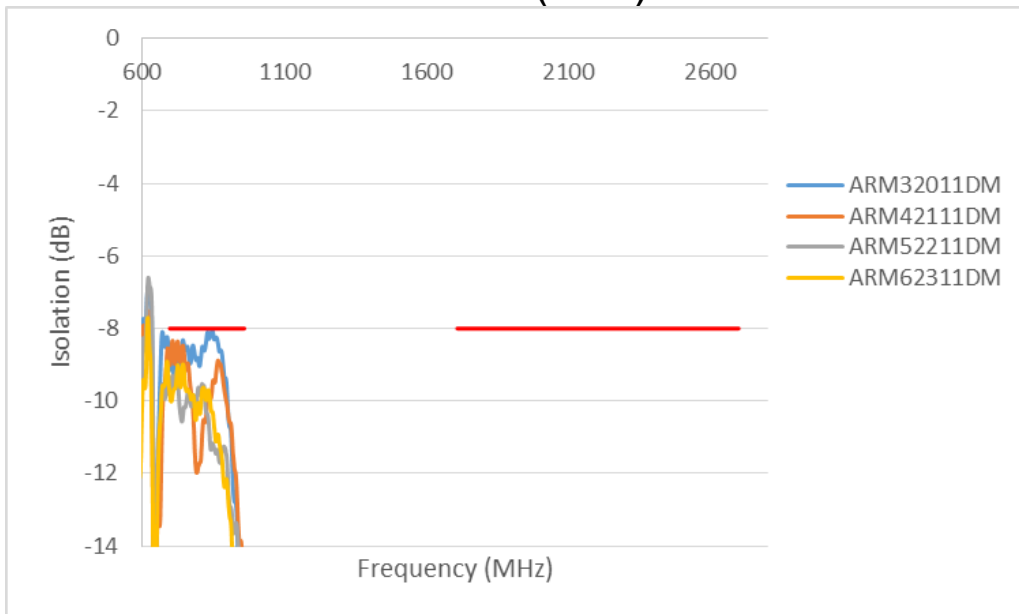

Note : Antenna tested with 5m cable on 500mm (dia) ground plane

Issue: 2034

In the effort to improve our products, we reserve the right to make changes judged to be necessary.

CONFIDENTIAL AND PROPRIETARY INFORMATION

This document contains confidential and proprietary information of Pulse Electronics, Inc. (Pulse) and is protected by copyright, trade secret and other state and federal laws. Its receipt or possession does not convey any rights to reproduce, disclose its contents, or to manufacture, use or sell anything it may describe. Reproduction, disclosure or use without specific written authorization of Pulse is strictly forbidden.

Series: ARMADILLO

Description: Vehicular Multiband Antenna with Direct Mount

PART NUMBER: ARMXXXXDM

CHARTS

Radiation Efficiency (LTE)

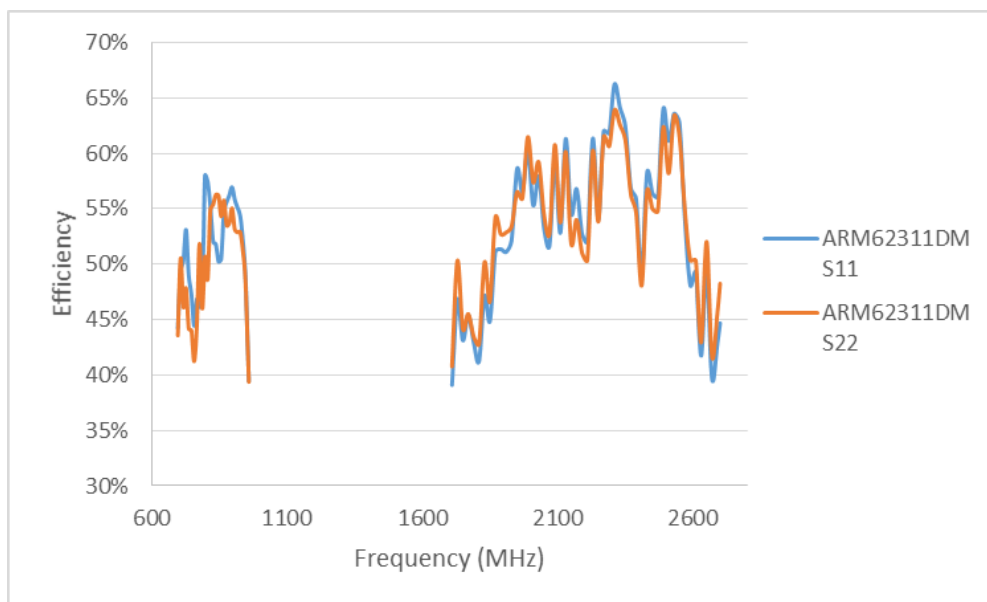

Peak Gain (LTE)

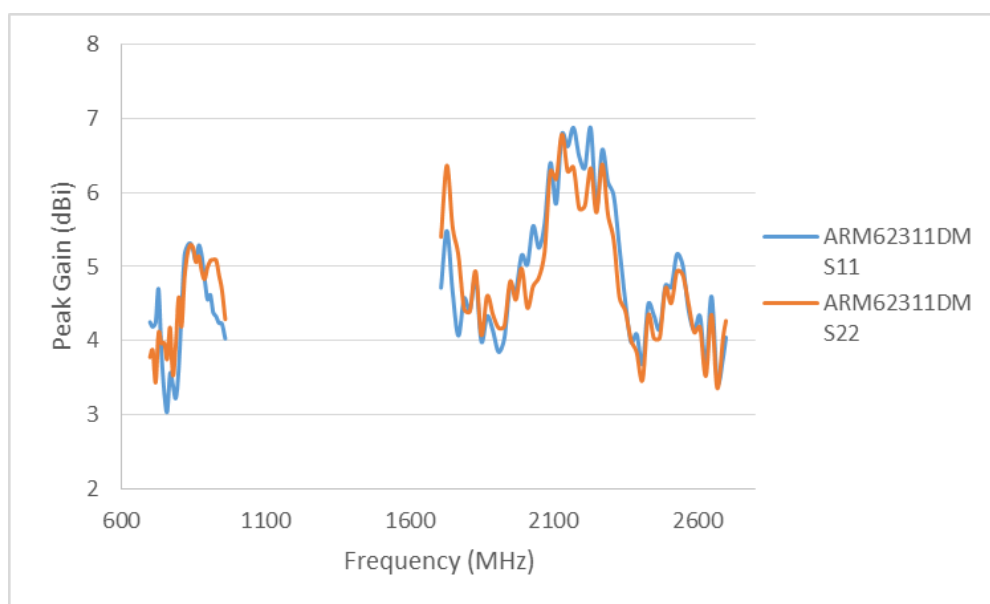

Note : Antenna tested with 1ft(304.8mm) cable on 500mm (dia) ground plane

Issue: 2034

In the effort to improve our products, we reserve the right to make changes judged to be necessary.

CONFIDENTIAL AND PROPRIETARY INFORMATION

This document contains confidential and proprietary information of Pulse Electronics, Inc. (Pulse) and is protected by copyright, trade secret and other state and federal laws. Its receipt or possession does not convey any rights to reproduce, disclose its contents, or to manufacture, use or sell anything it may describe. Reproduction, disclosure or use without specific written authorization of Pulse is strictly forbidden.

Series: ARMADILLO

Description: Vehicular Multiband Antenna with Direct Mount

PART NUMBER: ARMXXXXDM

CHARTS

VSWR (WIFI)

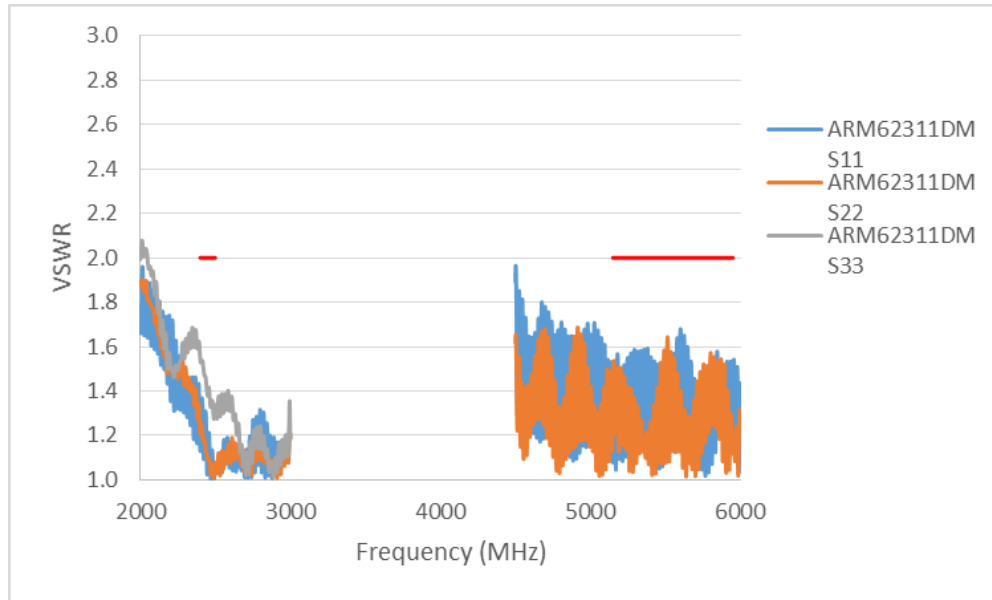

Isolation (WIFI)

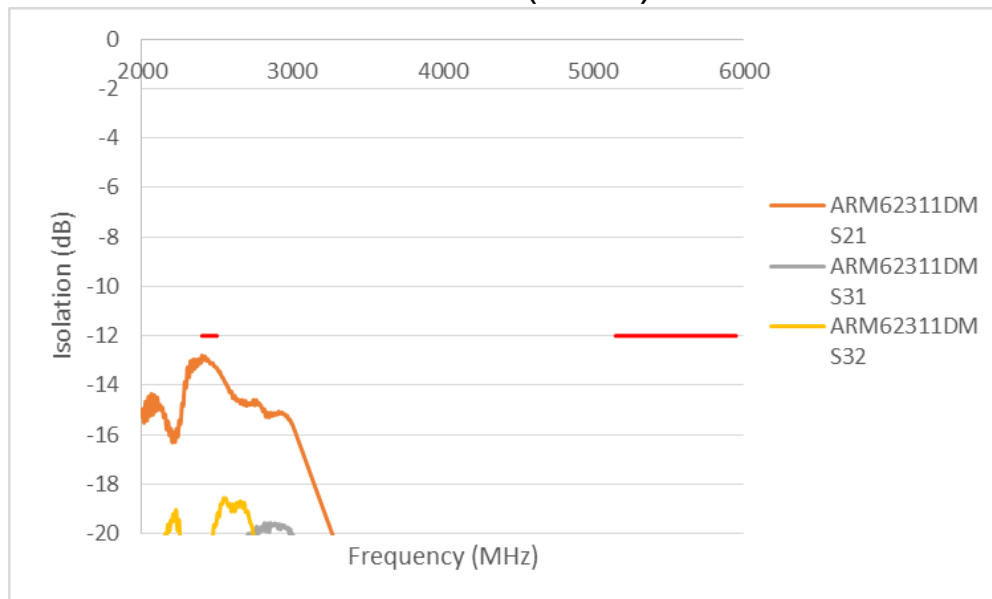

Note : Antenna tested with 5m cable on 500mm (dia) ground plane

Issue: 2034

In the effort to improve our products, we reserve the right to make changes judged to be necessary.

CONFIDENTIAL AND PROPRIETARY INFORMATION

This document contains confidential and proprietary information of Pulse Electronics, Inc. (Pulse) and is protected by copyright, trade secret and other state and federal laws. Its receipt or possession does not convey any rights to reproduce, disclose its contents, or to manufacture, use or sell anything it may describe. Reproduction, disclosure or use without specific written authorization of Pulse is strictly forbidden.

Description: Vehicular Multiband Antenna with Direct Mount

Series: ARMADILLO

PART NUMBER: ARMXXXXDM

CHARTS

Radiation Efficiency (WIFI)

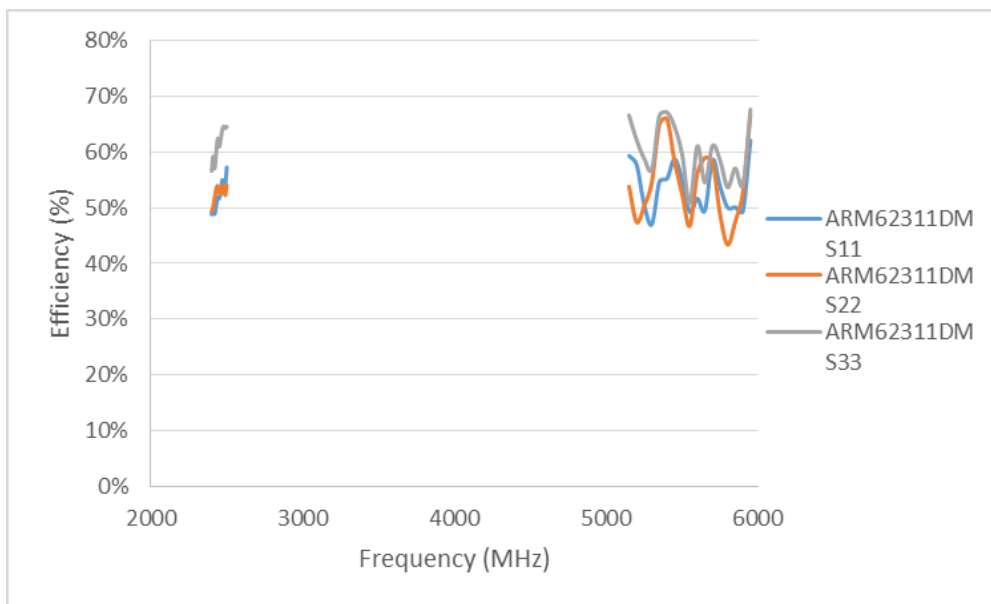

Peak Gain (WIFI)

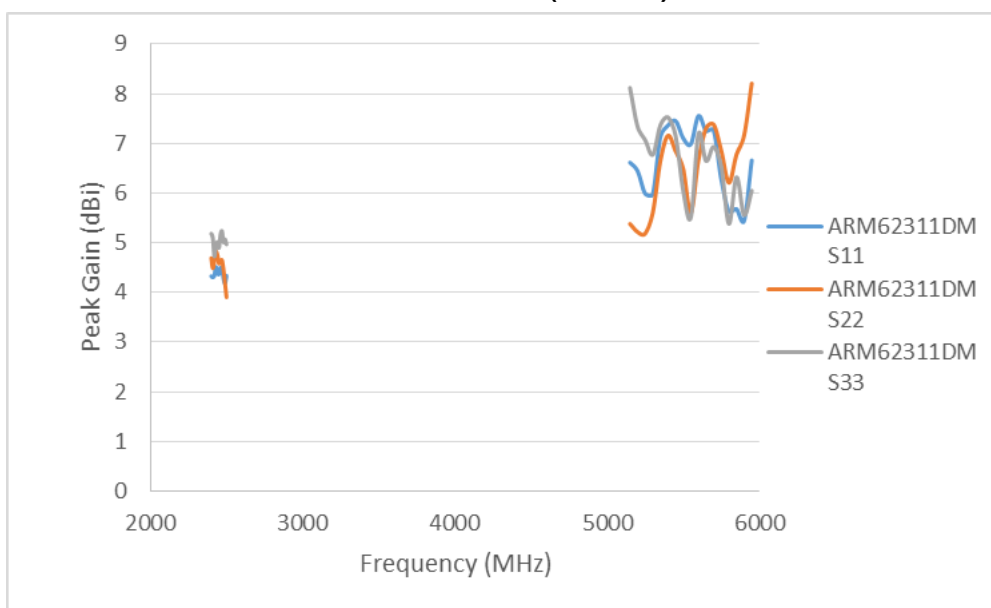

Note : Antenna tested with 1ft(304.8mm) cable on 500mm (dia) ground plane

Issue: 2034

In the effort to improve our products, we reserve the right to make changes judged to be necessary.

CONFIDENTIAL AND PROPRIETARY INFORMATION

This document contains confidential and proprietary information of Pulse Electronics, Inc. (Pulse) and is protected by copyright, trade secret and other state and federal laws. Its receipt or possession does not convey any rights to reproduce, disclose its contents, or to manufacture, use or sell anything it may describe. Reproduction, disclosure or use without specific written authorization of Pulse is strictly forbidden.

Description: Vehicular Multiband Antenna with Direct Mount

Series: ARMADILLO

PART NUMBER: ARMXXXXDM

CHARTS

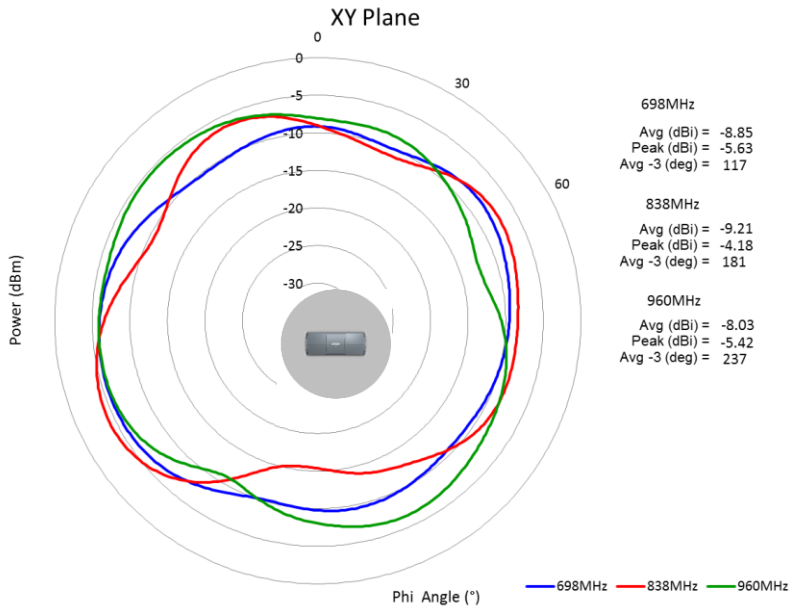

LTE1 XY plane radiation pattern

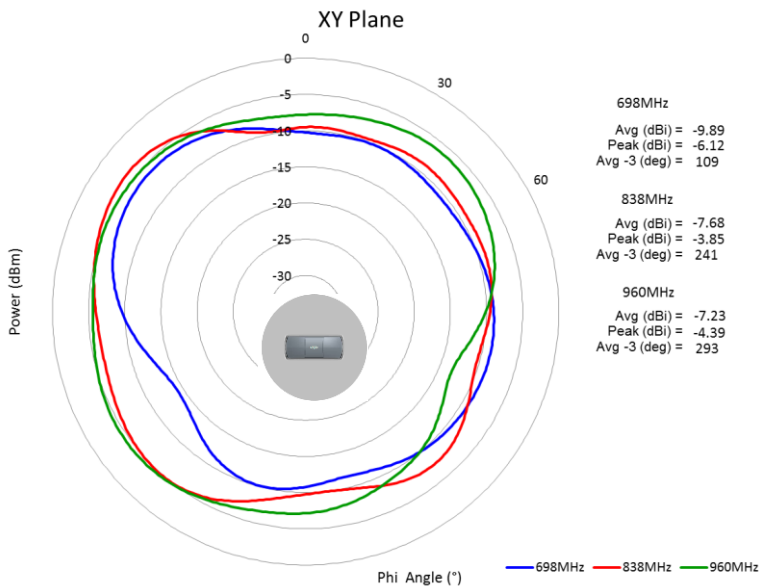

LTE2 XY plane radiation pattern

Issue: 2034

In the effort to improve our products, we reserve the right to make changes judged to be necessary.

CONFIDENTIAL AND PROPRIETARY INFORMATION

This document contains confidential and proprietary information of Pulse Electronics, Inc. (Pulse) and is protected by copyright, trade secret and other state and federal laws. Its receipt or possession does not convey any rights to reproduce, disclose its contents, or to manufacture, use or sell anything it may describe. Reproduction, disclosure or use without specific written authorization of Pulse is strictly forbidden.

Description: Vehicular Multiband Antenna with Direct Mount

Series: ARMADILLO

PART NUMBER: ARMXXXXDM

CHARTS

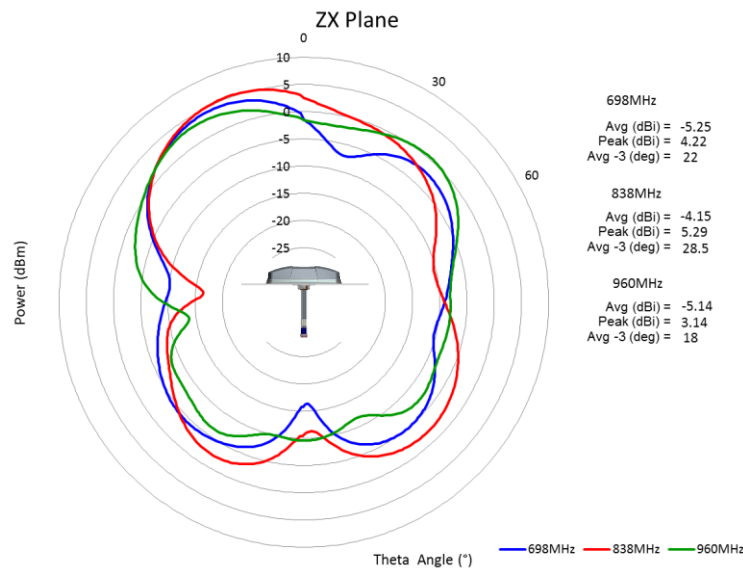

LTE1 ZX plane radiation pattern

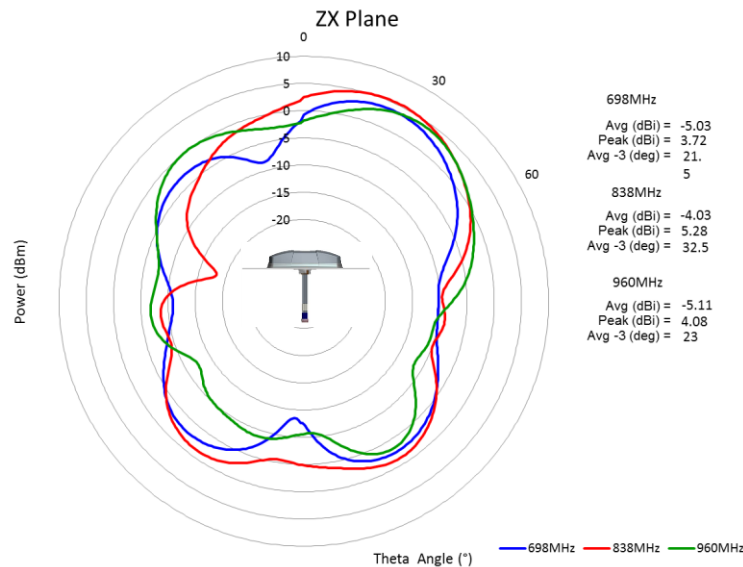

LTE2 ZX plane radiation pattern

Issue: 2034

In the effort to improve our products, we reserve the right to make changes judged to be necessary.

CONFIDENTIAL AND PROPRIETARY INFORMATION

This document contains confidential and proprietary information of Pulse Electronics, Inc. (Pulse) and is protected by copyright, trade secret and other state and federal laws. Its receipt or possession does not convey any rights to reproduce, disclose its contents, or to manufacture, use or sell anything it may describe. Reproduction, disclosure or use without specific written authorization of Pulse is strictly forbidden.

Description: Vehicular Multiband Antenna with Direct Mount

Series: ARMADILLO

PART NUMBER: ARMXXXXDM

CHARTS

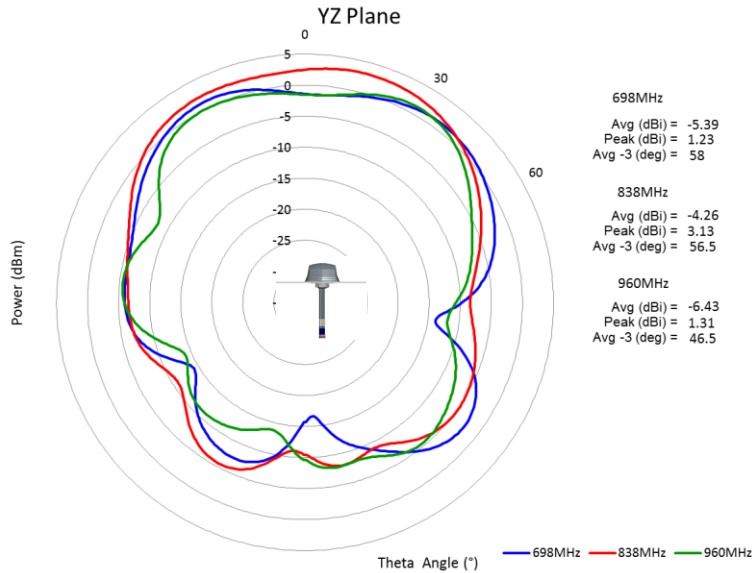

LTE1 YZ plane radiation pattern

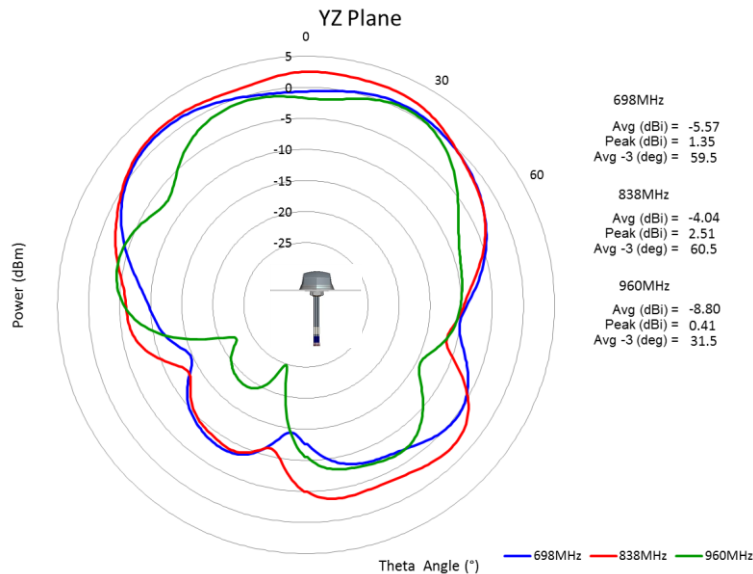

LTE2 YZ plane radiation pattern

Issue: 2034

In the effort to improve our products, we reserve the right to make changes judged to be necessary.

CONFIDENTIAL AND PROPRIETARY INFORMATION

This document contains confidential and proprietary information of Pulse Electronics, Inc. (Pulse) and is protected by copyright, trade secret and other state and federal laws. Its receipt or possession does not convey any rights to reproduce, disclose its contents, or to manufacture, use or sell anything it may describe. Reproduction, disclosure or use without specific written authorization of Pulse is strictly forbidden.

Description: Vehicular Multiband Antenna with Direct Mount

Series: ARMADILLO

PART NUMBER: ARMXXXXDM

CHARTS

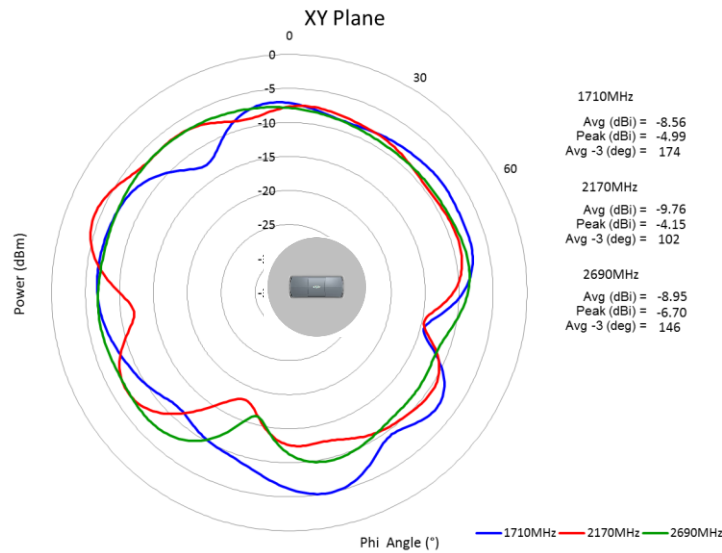

LTE1 XY plane radiation pattern

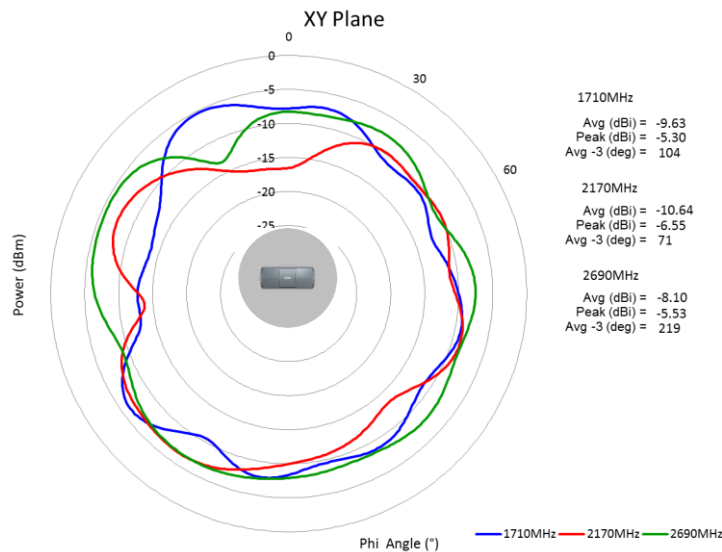

LTE2 XY plane radiation pattern

Issue: 2034

In the effort to improve our products, we reserve the right to make changes judged to be necessary.

CONFIDENTIAL AND PROPRIETARY INFORMATION

This document contains confidential and proprietary information of Pulse Electronics, Inc. (Pulse) and is protected by copyright, trade secret and other state and federal laws. Its receipt or possession does not convey any rights to reproduce, disclose its contents, or to manufacture, use or sell anything it may describe. Reproduction, disclosure or use without specific written authorization of Pulse is strictly forbidden.

Description: Vehicular Multiband Antenna with Direct Mount

Series: ARMADILLO

PART NUMBER: ARMXXXXDM

CHARTS

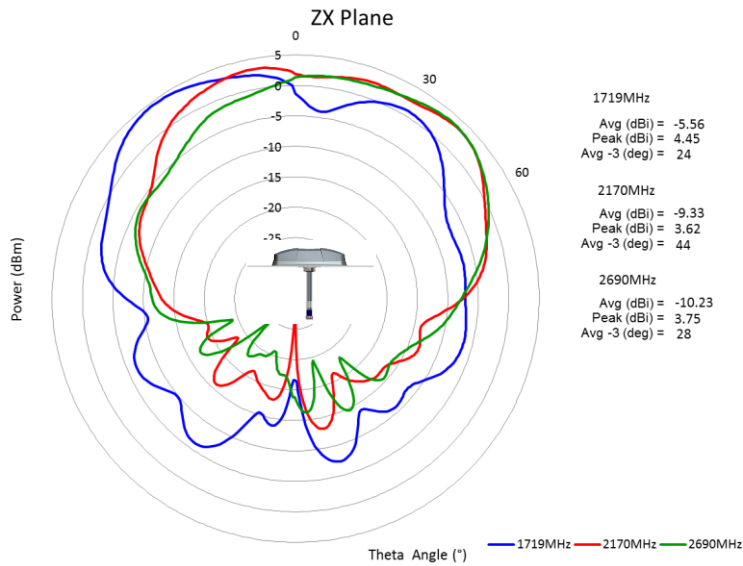

LTE1 ZX plane radiation pattern

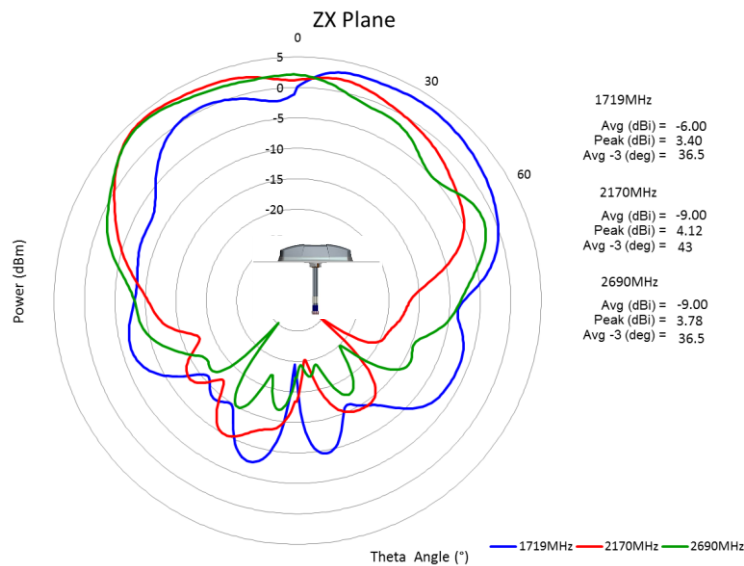

LTE2 ZX plane radiation pattern

Issue: 2034

In the effort to improve our products, we reserve the right to make changes judged to be necessary.

CONFIDENTIAL AND PROPRIETARY INFORMATION

This document contains confidential and proprietary information of Pulse Electronics, Inc. (Pulse) and is protected by copyright, trade secret and other state and federal laws. Its receipt or possession does not convey any rights to reproduce, disclose its contents, or to manufacture, use or sell anything it may describe. Reproduction, disclosure or use without specific written authorization of Pulse is strictly forbidden.

Description: Vehicular Multiband Antenna with Direct Mount

Series: ARMADILLO

PART NUMBER: ARMXXXXDM

CHARTS

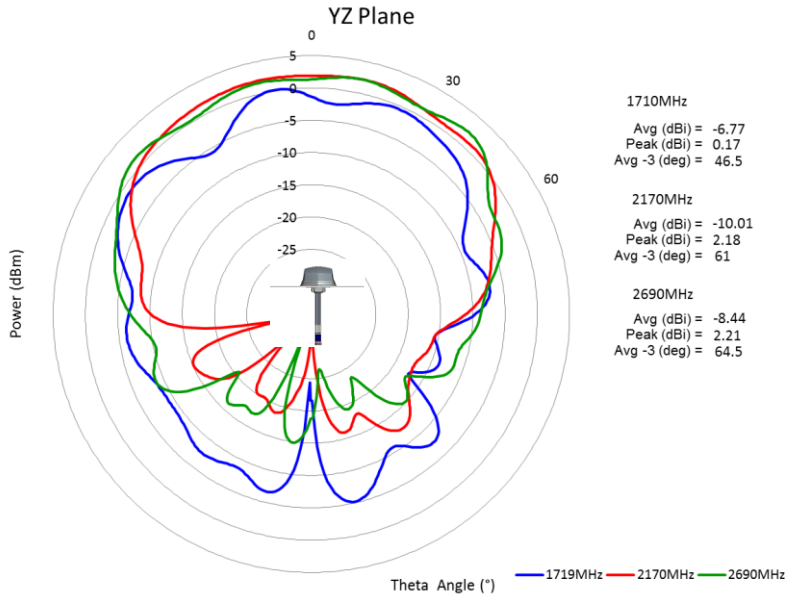

LTE1 YZ plane radiation pattern

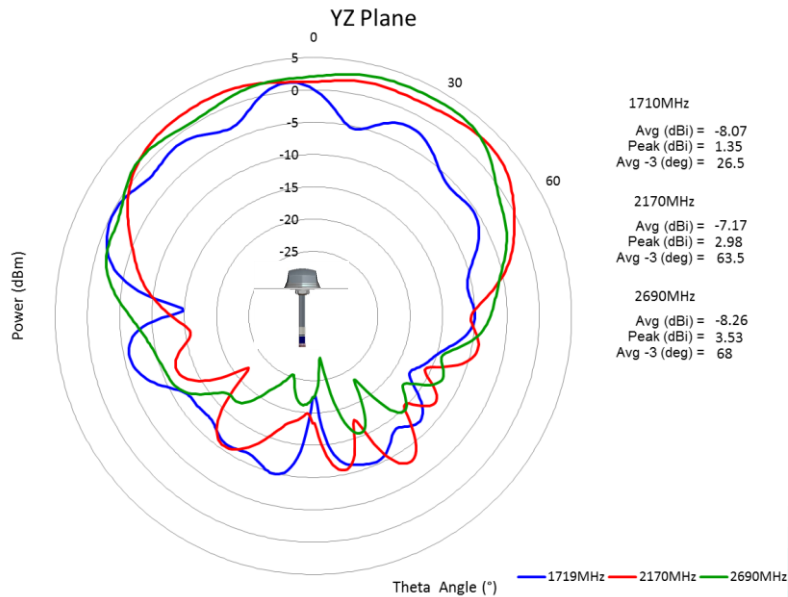

LTE2 YZ plane radiation pattern

Issue: 2034

In the effort to improve our products, we reserve the right to make changes judged to be necessary.

CONFIDENTIAL AND PROPRIETARY INFORMATION

This document contains confidential and proprietary information of Pulse Electronics, Inc. (Pulse) and is protected by copyright, trade secret and other state and federal laws. Its receipt or possession does not convey any rights to reproduce, disclose its contents, or to manufacture, use or sell anything it may describe. Reproduction, disclosure or use without specific written authorization of Pulse is strictly forbidden.

Description: Vehicular Multiband Antenna with Direct Mount

Series: ARMADILLO

PART NUMBER: ARMXXXXDM

CHARTS

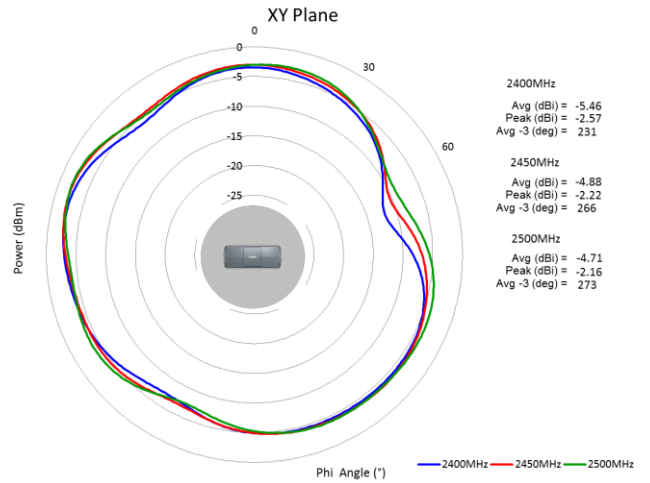
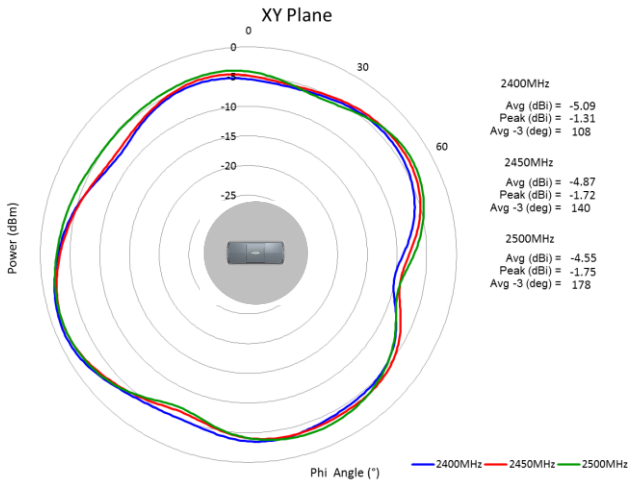

WiFi1 XY plane radiation pattern

WiFi2 XY plane radiation pattern

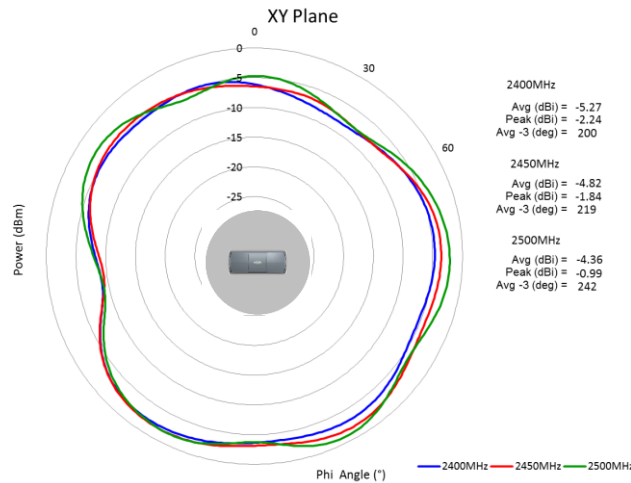

WiFi3 XY plane radiation pattern

Issue: 2034

In the effort to improve our products, we reserve the right to make changes judged to be necessary.

CONFIDENTIAL AND PROPRIETARY INFORMATION

This document contains confidential and proprietary information of Pulse Electronics, Inc. (Pulse) and is protected by copyright, trade secret and other state and federal laws. Its receipt or possession does not convey any rights to reproduce, disclose its contents, or to manufacture, use or sell anything it may describe. Reproduction, disclosure or use without specific written authorization of Pulse is strictly forbidden.

Description: Vehicular Multiband Antenna with Direct Mount

Series: ARMADILLO

PART NUMBER: ARMXXXXDM

CHARTS

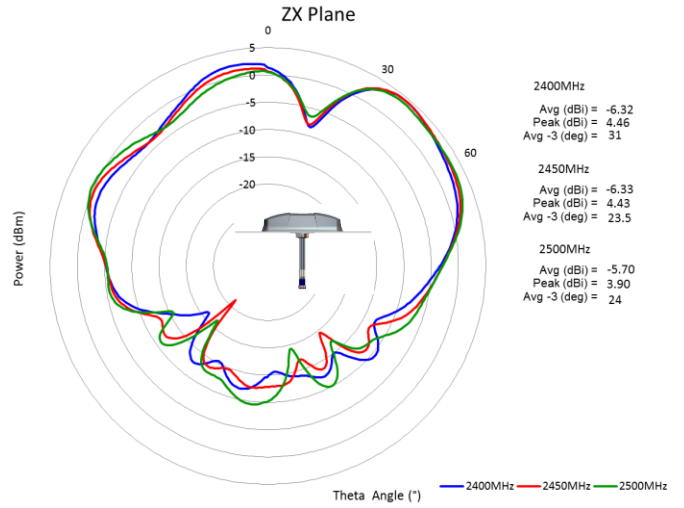
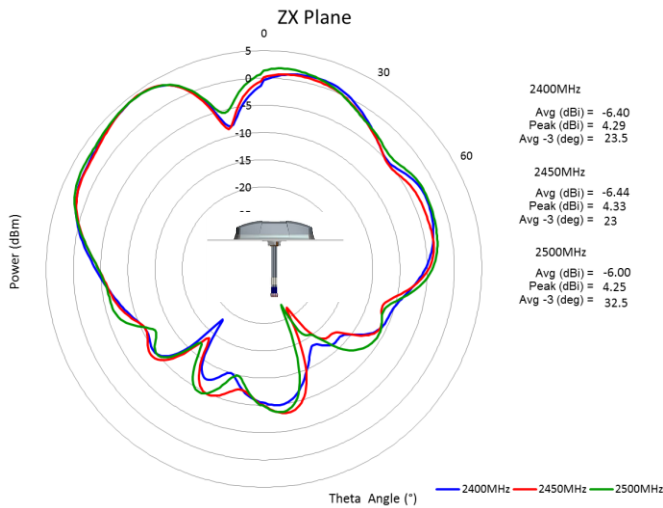

WiFi1 ZX plane radiation pattern

WiFi2 ZX plane radiation pattern

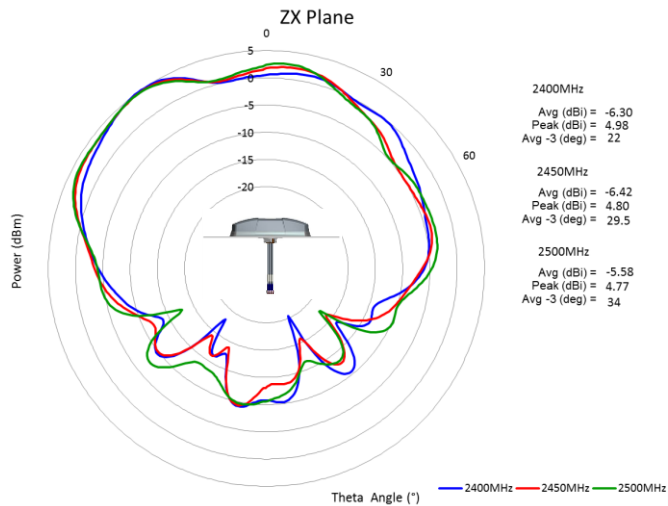

WiFi3 ZX plane radiation pattern

Issue: 2034

In the effort to improve our products, we reserve the right to make changes judged to be necessary.

CONFIDENTIAL AND PROPRIETARY INFORMATION

This document contains confidential and proprietary information of Pulse Electronics, Inc. (Pulse) and is protected by copyright, trade secret and other state and federal laws. Its receipt or possession does not convey any rights to reproduce, disclose its contents, or to manufacture, use or sell anything it may describe. Reproduction, disclosure or use without specific written authorization of Pulse is strictly forbidden.

Description: Vehicular Multiband Antenna with Direct Mount

Series: ARMADILLO

PART NUMBER: ARMXXXXDM

CHARTS

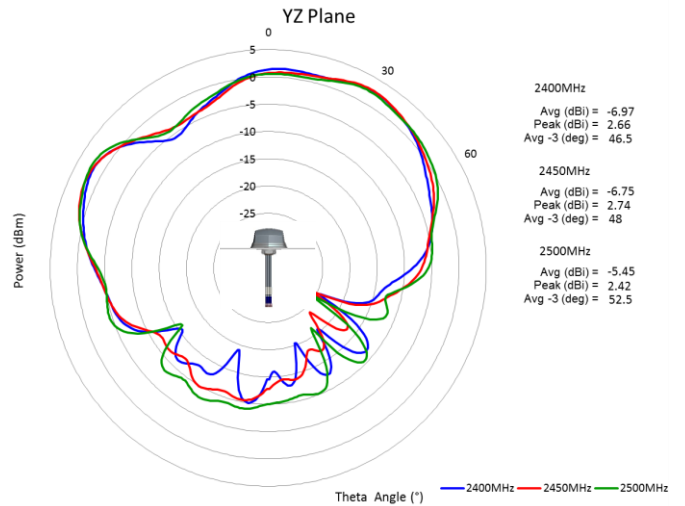
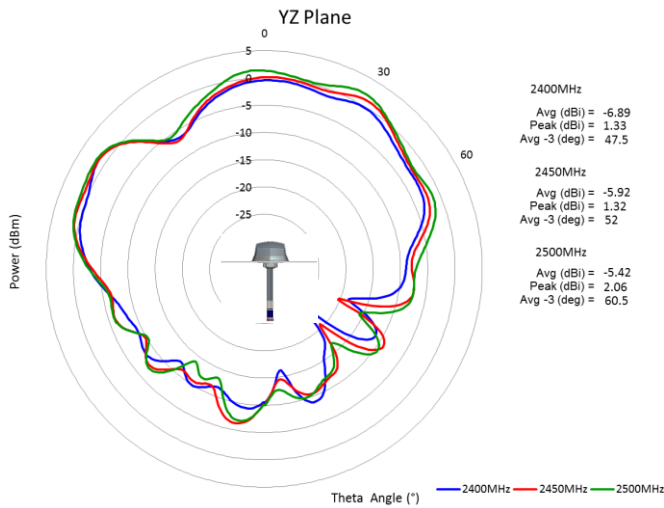

WiFi1 YZ plane radiation pattern

WiFi2 YZ plane radiation pattern

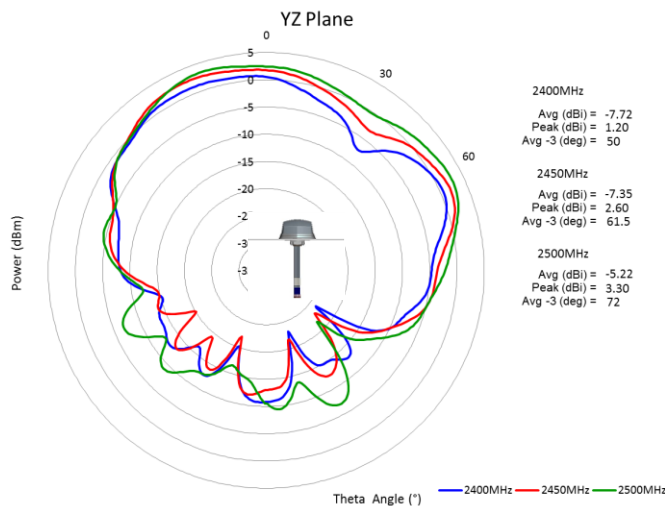

WiFi3 YZ plane radiation pattern

Issue: 2034

In the effort to improve our products, we reserve the right to make changes judged to be necessary.

CONFIDENTIAL AND PROPRIETARY INFORMATION

This document contains confidential and proprietary information of Pulse Electronics, Inc. (Pulse) and is protected by copyright, trade secret and other state and federal laws. Its receipt or possession does not convey any rights to reproduce, disclose its contents, or to manufacture, use or sell anything it may describe. Reproduction, disclosure or use without specific written authorization of Pulse is strictly forbidden.

Description: Vehicular Multiband Antenna with Direct Mount

Series: ARMADILLO

PART NUMBER: ARMXXXXDM

CHARTS

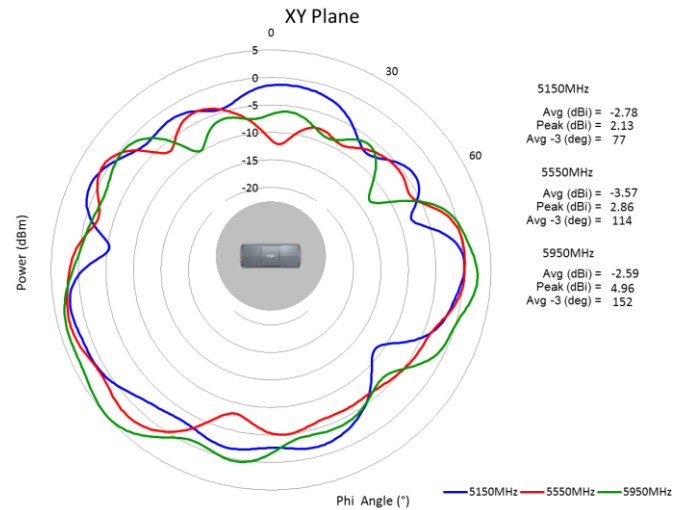
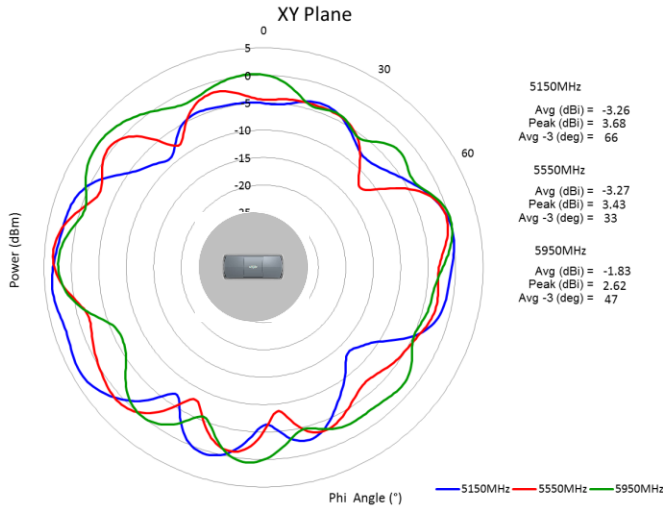

WiFi1 XY plane radiation pattern

WiFi2 XY plane radiation pattern

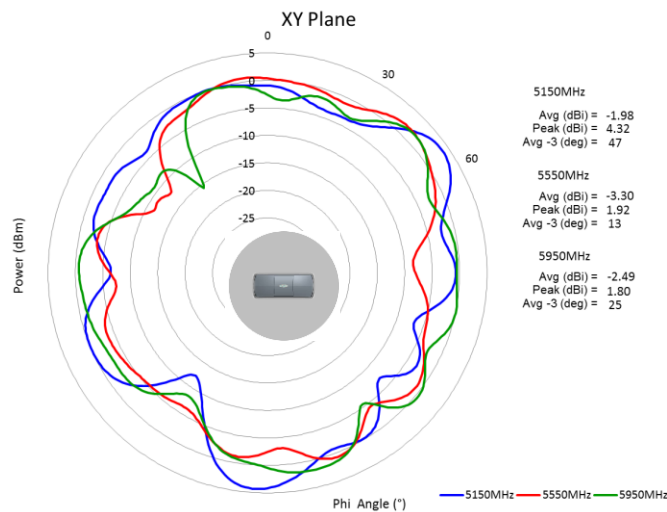

WiFi3 XY plane radiation pattern

Issue: 2034

In the effort to improve our products, we reserve the right to make changes judged to be necessary.

CONFIDENTIAL AND PROPRIETARY INFORMATION

This document contains confidential and proprietary information of Pulse Electronics, Inc. (Pulse) and is protected by copyright, trade secret and other state and federal laws. Its receipt or possession does not convey any rights to reproduce, disclose its contents, or to manufacture, use or sell anything it may describe. Reproduction, disclosure or use without specific written authorization of Pulse is strictly forbidden.

Description: Vehicular Multiband Antenna with Direct Mount

Series: ARMADILLO

PART NUMBER: ARMXXXXDM

CHARTS

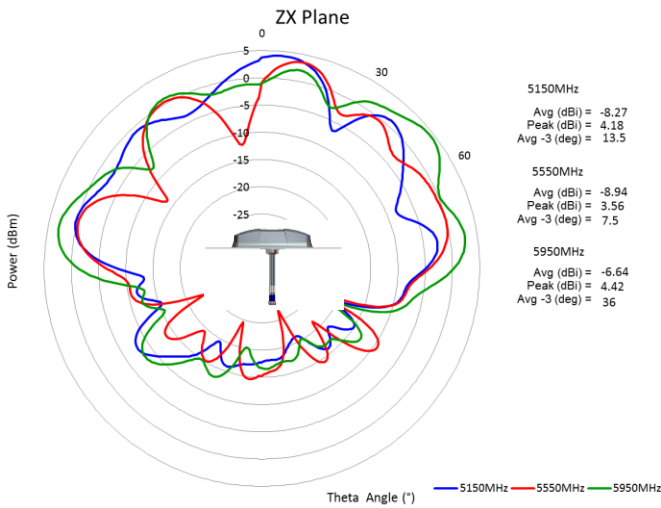

WiFi1 ZX plane radiation pattern

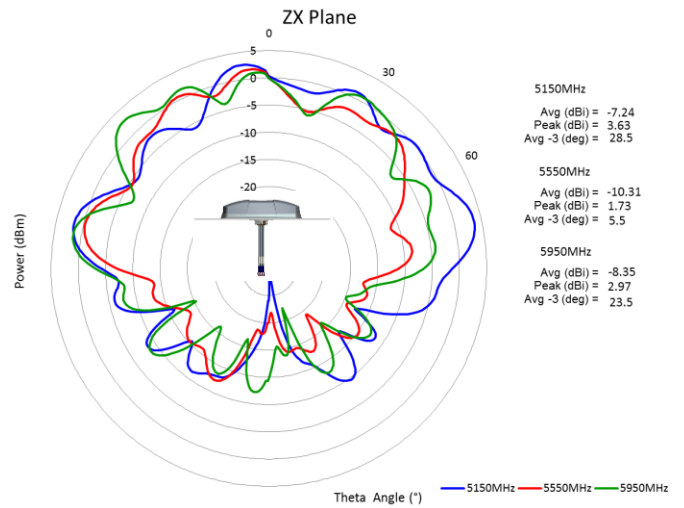

WiFi2 ZX plane radiation pattern

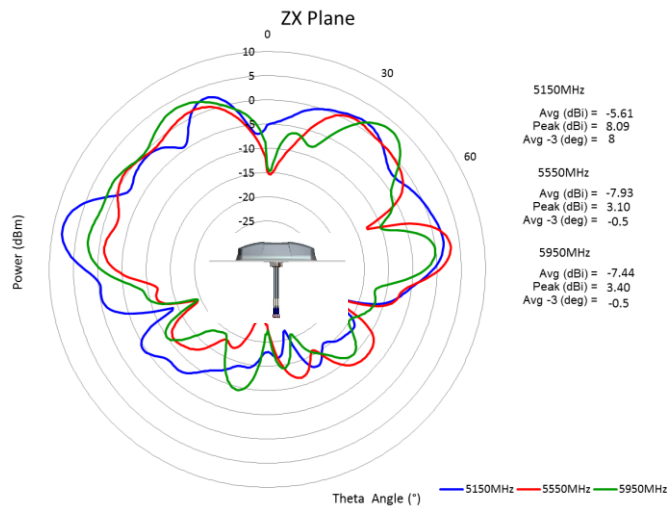

WiFi3 ZX plane radiation pattern

Issue: 2034

In the effort to improve our products, we reserve the right to make changes judged to be necessary.

CONFIDENTIAL AND PROPRIETARY INFORMATION

This document contains confidential and proprietary information of Pulse Electronics, Inc. (Pulse) and is protected by copyright, trade secret and other state and federal laws. Its receipt or possession does not convey any rights to reproduce, disclose its contents, or to manufacture, use or sell anything it may describe. Reproduction, disclosure or use without specific written authorization of Pulse is strictly forbidden.

Description: Vehicular Multiband Antenna with Direct Mount

Series: ARMADILLO

PART NUMBER: ARMXXXXDM

CHARTS

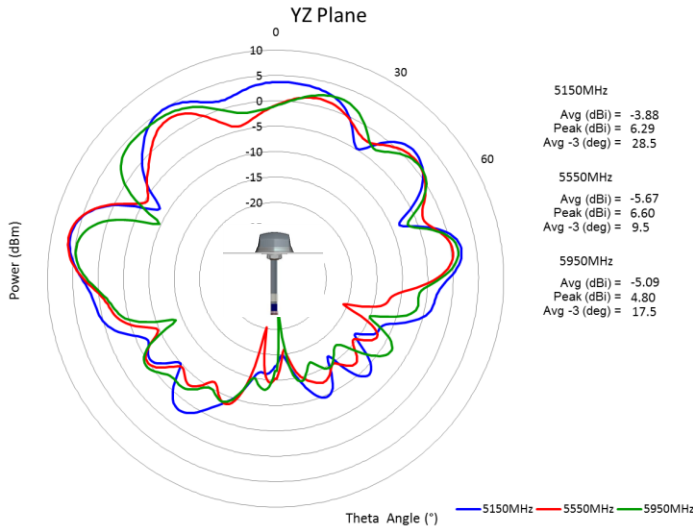

WiFi1 YZ plane radiation pattern

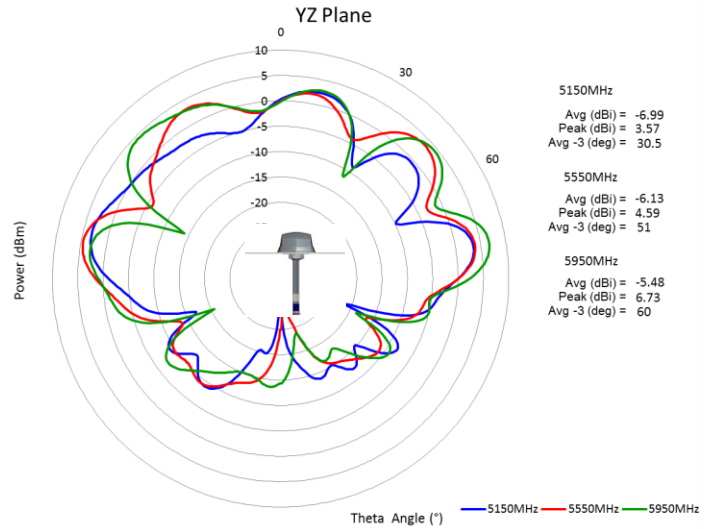

WiFi2 YZ plane radiation pattern

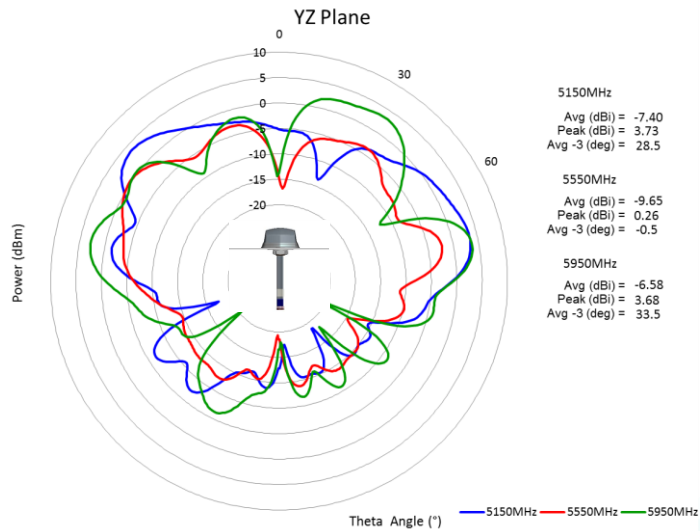

WiFi3 YZ plane radiation pattern

Issue: 2034

In the effort to improve our products, we reserve the right to make changes judged to be necessary.

CONFIDENTIAL AND PROPRIETARY INFORMATION

This document contains confidential and proprietary information of Pulse Electronics, Inc. (Pulse) and is protected by copyright, trade secret and other state and federal laws. Its receipt or possession does not convey any rights to reproduce, disclose its contents, or to manufacture, use or sell anything it may describe. Reproduction, disclosure or use without specific written authorization of Pulse is strictly forbidden.

Series: ARMADILLO

Description: Vehicular Multiband Antenna with Direct Mount

PART NUMBER: ARMXXXXDM

PACKAGING

Each antennas packed in Bubble Bag

6 bags of antennas (Total 6pcs) packed in a cardboard box

1 label on each box with quantity, part number, date code.

Mouser Electronics

Authorized Distributor

Click to View Pricing, Inventory, Delivery & Lifecycle Information:

Pulse:

[ARM21011DM](#) [ARM42111DM](#) [ARM21012DM](#) [ARM32012DM](#) [ARM42112DM](#) [ARM52212DM](#) [ARM62311DM](#)
[ARM32011DM](#) [ARM62312DM](#) [ARM52211DM](#) [ARM22001DM](#)