

AST-01532MR-R 15mm Speaker



3541 Stop Eight Road • Dayton, Ohio 45414

Product Overview

- 15mm diameter speaker with Neodymium magnet for 87 dB sensitivity
- 0.3W continuous, 0.5W maximum power handling and 32Ω impedance
- Mylar cone for wide frequency response
- Thru hole design and wave solderable for PCB mount

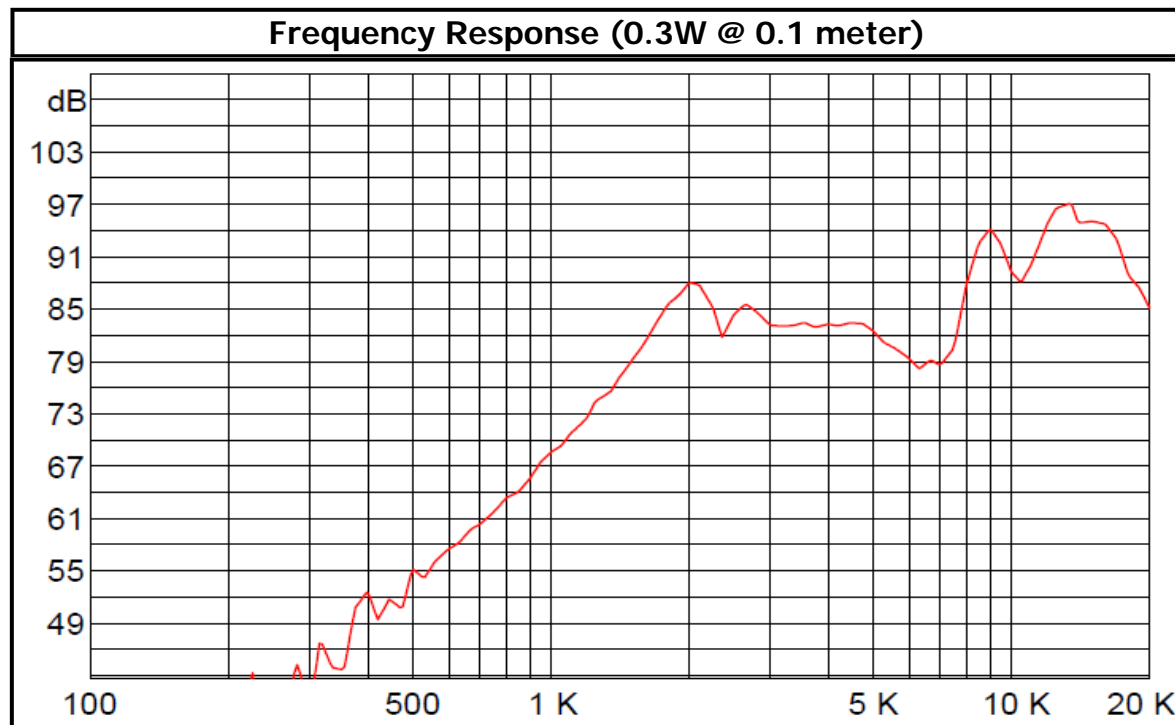

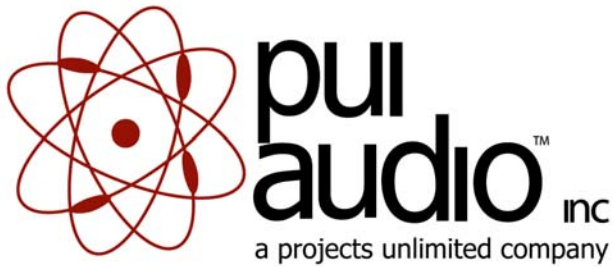

AST-01532MR-R 15mm Speaker

Mechanical and Environment Testing	
Test Description	Test Condition
High Temperature	55°C with random humidity for 96 hours
Low Temperature	-20°C with random humidity for 96 hours
Humidity	40°C with 90% to 95% relative humidity for 96 hours
Vibration	1.5 mm movement modulated at 10 to 55 Hz for 2 hours
Drop Test	75 cm free fall onto 40 mm thick board, 10 cycles
Temperature Cycle Test	-20°C to 55°C, 5 cycles (refer to Temperature Cycle Test Graph)

After tests, speaker shall rest for 1 hours. SPL shall not deviate ± 3 dB from pre-test measurement.

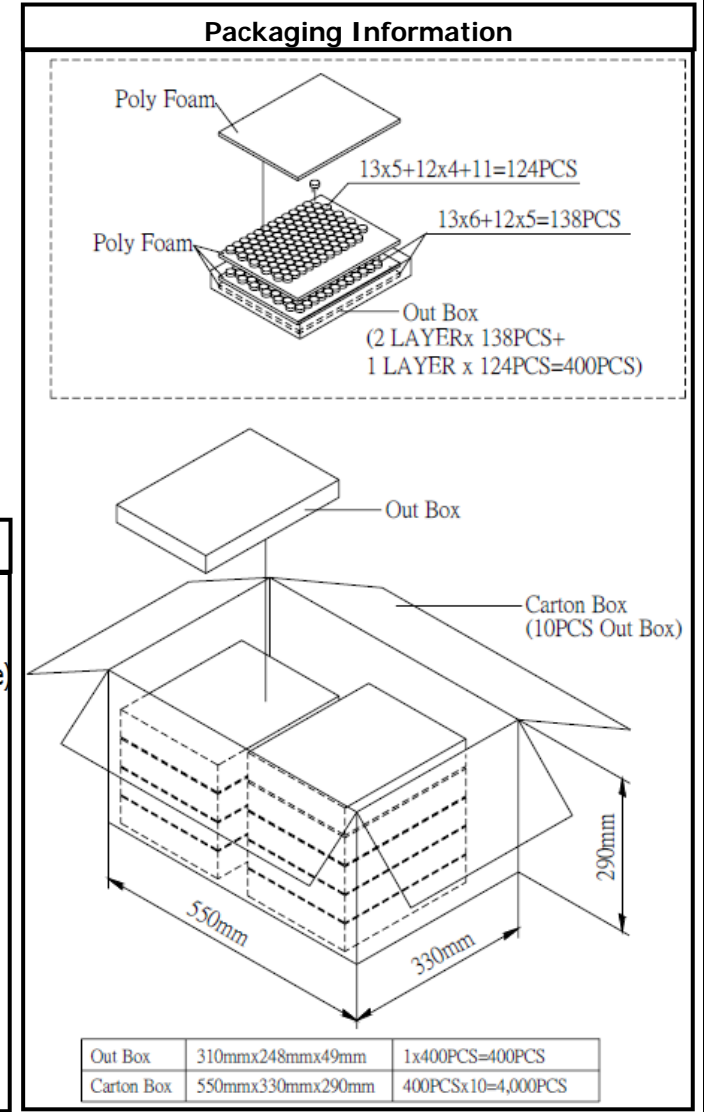
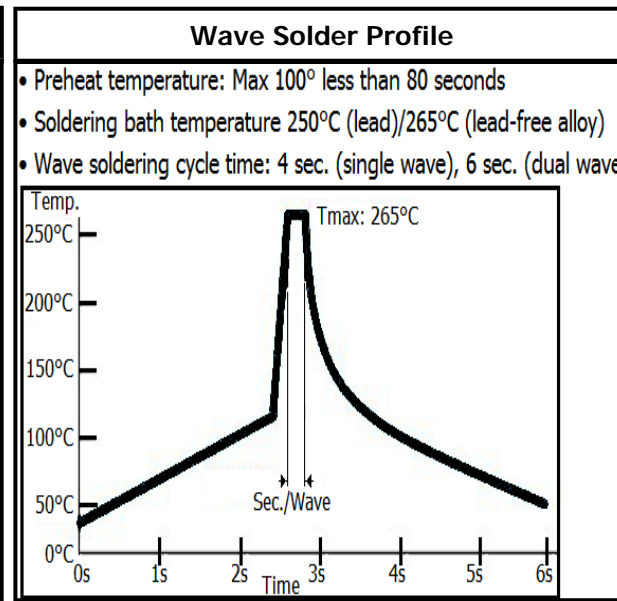
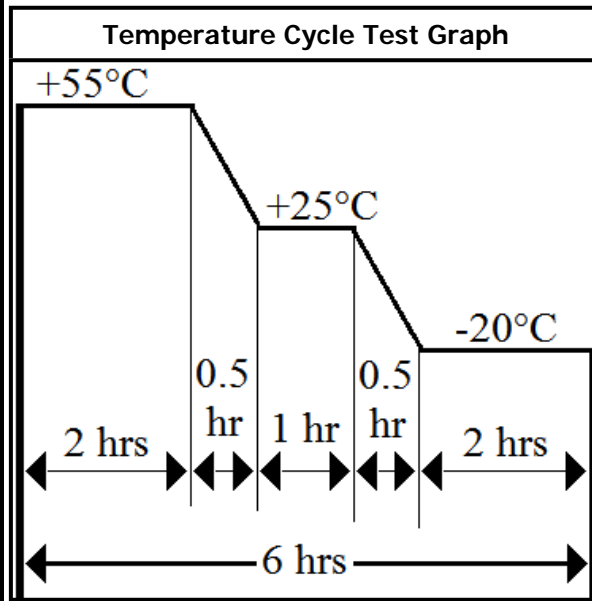

SPECIFICATIONS

PARAMETERS	VALUES	UNITS
RATED INPUT POWER	0.3	W
MAX INPUT POWER	0.5	W
IMPEDANCE	32 ± 15%	OHM
OUTPUT SPL @ 0.3W/0.1M (AT 2.0, 2.5, 3.0, 4.0 kHz)	87 ± 3	dB
DISTORTION (MAX.)	10%	-
RESONANT FREQUENCY	2,100 ± 20%	Hz
FREQUENCY RANGE	2,100 ~ 20,000	Hz
HOUSING MATERIAL	PBT	-
CONE MATERIAL	MYLAR	-
MAGNET MATERIAL	Nd-Fe-B	-
OPERATING TEMPERATURE	-20 ~ +55	°C
WEIGHT	2	grams

THIS DOCUMENT CONTAINS DATA PROPRIETARY TO PROJECTS UNLIMITED, INC. ANY USE OR REPRODUCTION, IN ANY FORM, WITHOUT PRIOR WRITTEN PERMISSION OF PROJECTS UNLIMITED, INC. IS PROHIBITED.
©2003, Projects Unlimited Inc.

REVISION HISTORY

LTR	DESCRIPTION	DATE	APPROVED
-	RELEASED FROM ENGINEERING	5/9/2006	
A	REVISED TO INVENTOR 3-D DRAWING TEMPLATE	6/26/2008	B.R.

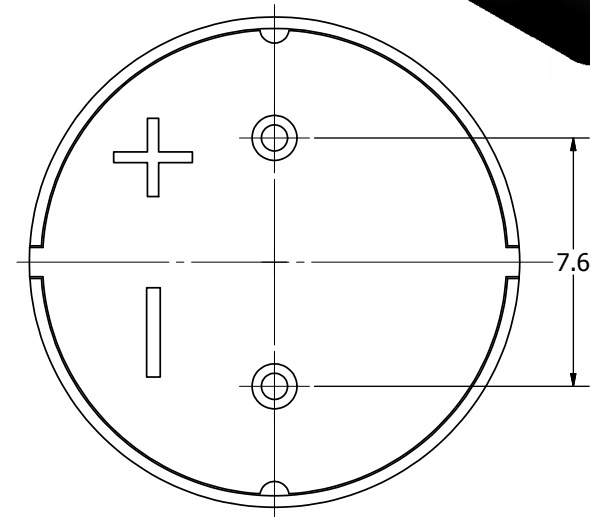
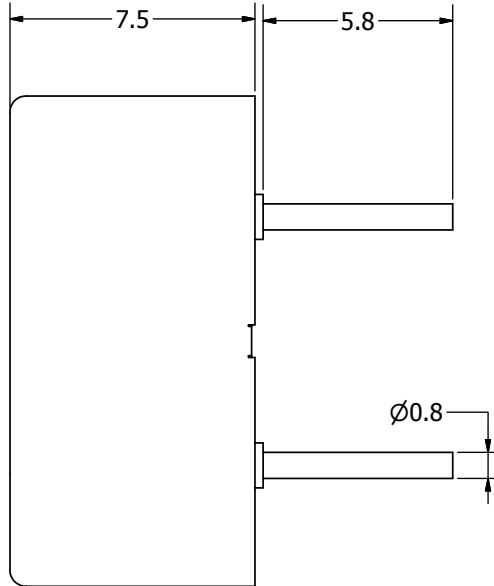
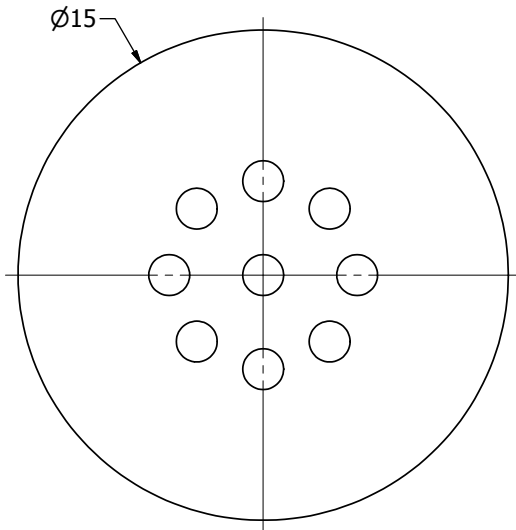

NOTES:

1. ALL DIMENSIONS ARE IN MILLIMETERS.
2. SPECIFICATIONS SUBJECT TO CHANGE OR WITHDRAWAL WITHOUT NOTICE.
3. THIS PART IS RoHS 2002/95/EC COMPLIANT.

UNLESS OTHERWISE SPECIFIED: DIMENSIONS ARE IN MILLIMETERS, TOLERANCES ARE ±0.5 AND ANGLES ARE ±3°.	SIZE	Designed by	Date	Checked by	Date	Approved by	Date	Drawn Date
	A3	J.D.	5/8/2006	E.P.	5/8/2006	B.R.	5/8/2006	6/26/2008
AST-01532MR-R.idw			AST-01532MR-R			Speaker	Edition	Sheet
						-	1 / 1	

Mouser Electronics

Authorized Distributor

Click to View Pricing, Inventory, Delivery & Lifecycle Information:

[PUI Audio:](#)

[AST-01532MR-R](#)