

Sealed Nickel Cadmium Batteries

Model: PS-C

Specifications

Nominal Voltage		1.2 Volt
Rated Capacity		2000 mAh
Dimensions	Diameter in. (mm)	1.00 (25.3)
	Height in. (mm)	1.93 (49.0)
	Height with solder tabs	1.97 (50.0)
	Weight Approx.	68 gm
	Internal Resistance	< 20 mΩ
	Standard Charge (0.1C)	200 mA
	Trickle Charge	(0.03C)~(0.05C)
	Fast Charge ΔV	600 mA
Recommended Operating Temperature Range	Std/Trickle Charge	20±5°C
	Fast Charge	20±5°C
	Discharge	20±5°C
	Storage	-20°C to 45°C
Standard Discharge (0.2C) Cut Off Voltage		1.0V per cell
High Rate Discharge (1 C) Cut Off Voltage		1.0V per cell

Dimensions

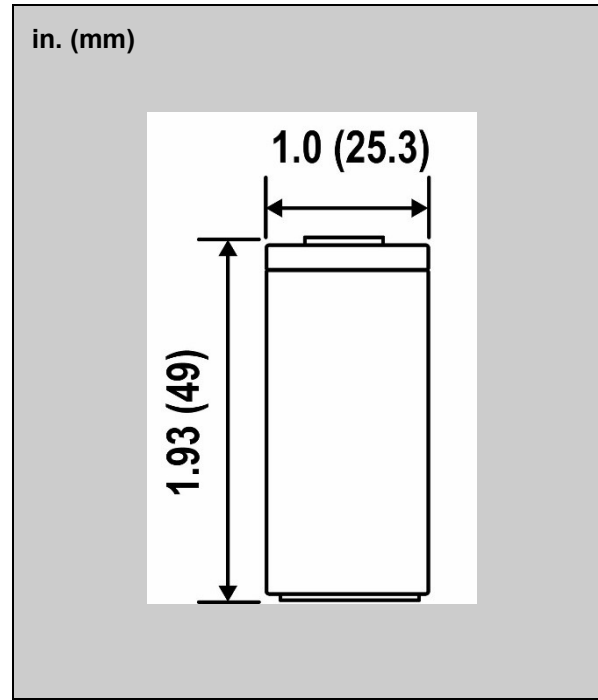

Charging and Discharging Characteristics

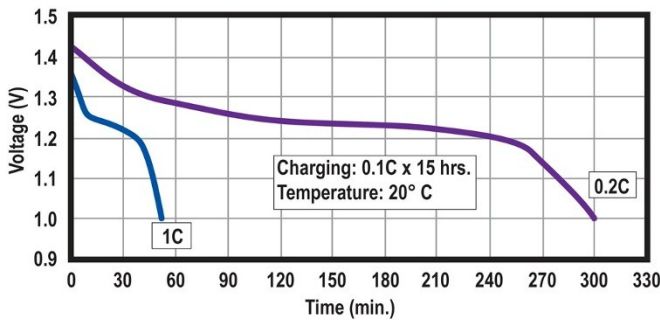

Discharge

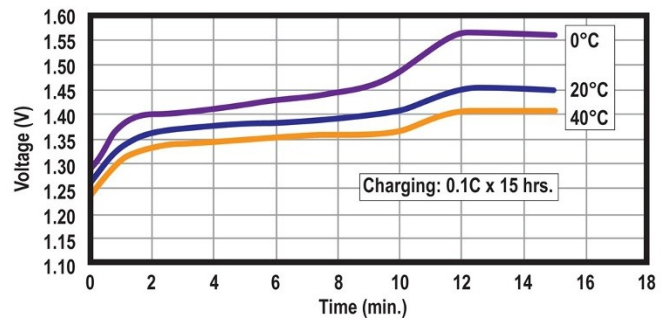

Standard Charge

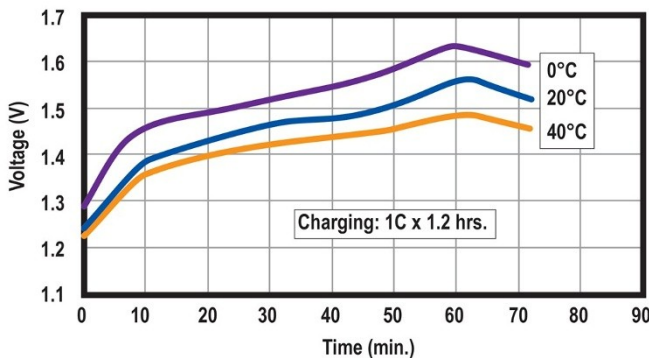

Fast Charge

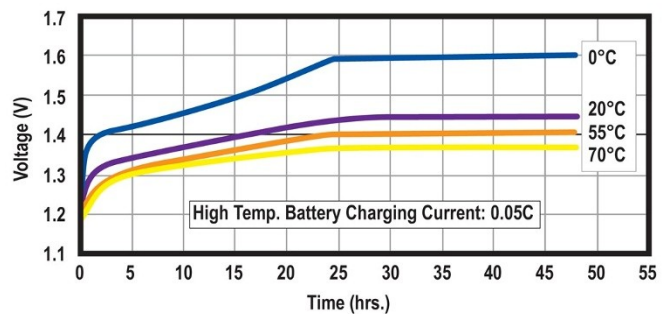

Trickle Charge

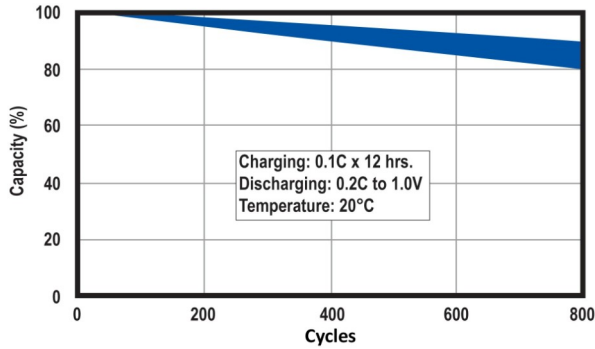

▲ Standard Battery Cycle Life ▲

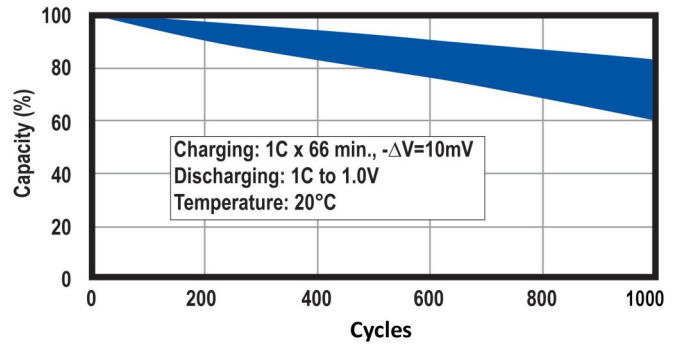

▲ Fast Charging Cycle Life ▲

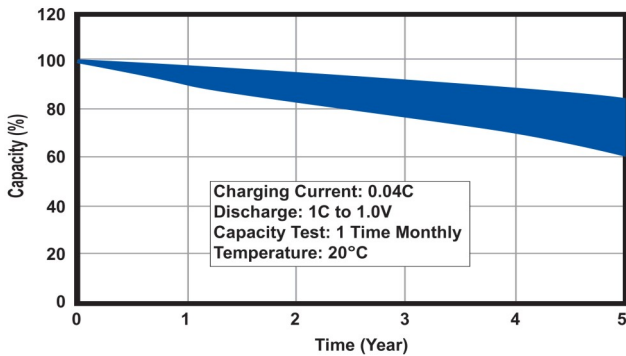

▲ Cycle Life Using Trickle Charging ▲

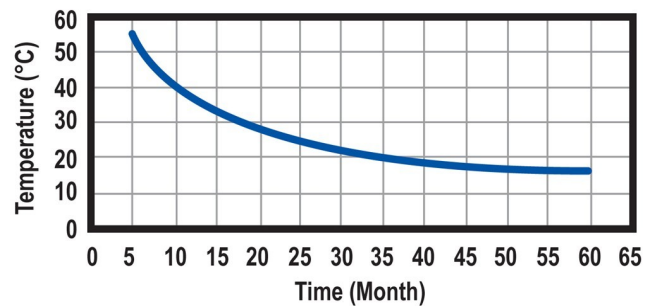

▲ Stand-by Battery Life ▲

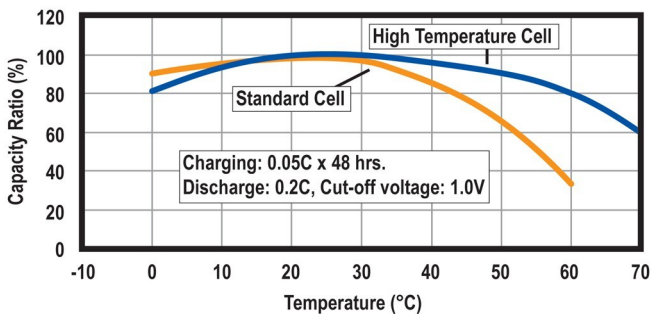

▲ Capacity vs. Temperature ▲

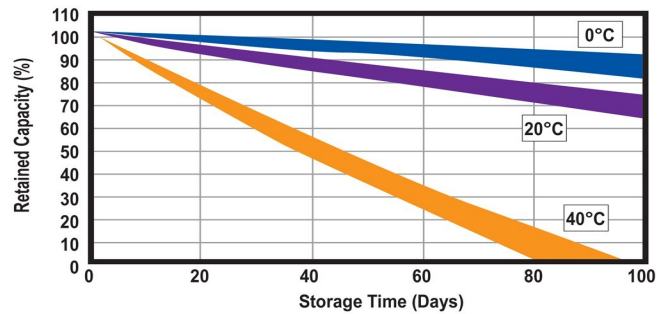

▲ Retained Capacity In Storage ▲

Corporate Headquarters and Domestic Sales
 Power-Sonic Corporation • 7550 Panasonic Way • San Diego, CA 92154 • U.S.A.
 Phone: (619) 661-2020 • Fax: (619) 661.3650
 Email Sales: national-sales@power-sonic.com
 Email Customer Service: customer-service@power-sonic.com
 E-mail Technical Support: technical-support@power-sonic.com

International Sales
 Power-Sonic Corporation • P.O. Box 5242 • Redwood City, CA 94063 • U.S.A.
 Phone: (650) 364-5001 • Fax: (650) 366-3662
 Email Sales: international-sales.com@power-sonic.com

www.power-sonic.com

Mouser Electronics

Authorized Distributor

Click to View Pricing, Inventory, Delivery & Lifecycle Information:

[Power-Sonic:](#)

[PS-C](#) [PS-C-T](#)