

Magnetic rotary angle and position sensor-control.

Contactless sensor. MTS-360

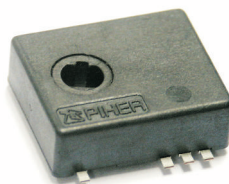

The MTS-360 provides a true breakthrough in contactless sensor technology by combining a through-shaft design with 360° absolute position feedback in an ultra miniature size. The result is the smallest fully featured rotary sensor on the market with reliability up to 50 million cycles.

With its tiny size of only 6mm x 17mm x 18mm (HxWxL), engineers can now integrate a fully featured rotary sensor directly on their PCB without the packaging issues that typically accompany encoders or other absolute position devices. The exceptionally low profile fits easily in places that were previously too small for pre-packaged rotary sensors.

This ultra-miniature MTS-360 Rotary Position Sensor is ideal in optical imaging stabilization and precision biomedical devices, optical zoom devices, consumer electronics, instrumentation, HVAC systems, automotive control systems, marine controls, fork lift trucks, farm equipment, cranes, low speed motor feedback, valve position sensors and robotic and automation feedback system.

Mechanical specifications

Rotational life (depends on application and mounting)	up to 50.000.000 cycles.
Operating temperature ¹	up to -40°C to +125°C
Sealing ¹	IP50

Electrical specifications

Linearity ¹	±1% absolute (±0.5% check availability).
Angular range	Programmable from 15 to 360 degrees (without dead band).
Output	Analog (Ratiometric), PWM, Serial Protocol.
Switch output	Yes, programmable.
Angular Resolution (depends on electrical angle and rotational speed)	Analog & PWM: up to 12 bits. Serial Protocol (SPI): up to 14 bits.
Operating temperature	-40°C to +85°C (-13°F to + 158°F)
Supply voltage ¹	5V ±10%
Supply current	Typ 8.5mA for single version Typ 17mA for redundant version

¹ Others check availability.

Piher Sensors & Controls SA

Our product competencies and services:
Potentiometers | **Position / angle sensors** | Rotary switches | Incremental encoders
Printed circuit resistors | Mechatronics | Value added assemblies

Key features

- Simple & Robust Magnetic Design.
- Multiturn.
- Programmable switch output.
- Programmable Linear Transfer Characteristic: (some positive slopes & one negative slope can be programmed in the same transfer characteristic; up to 4 programmable points; see last page)
- Self-Diagnostic features
- Over voltage protection and reverse voltage protection.

Also upon request:

- True full redundant version.

Applications

- Non-Contacting long life angle/position sensor.
- Absolute rotary position sensor
- Pedal position Sensor.
- Turn counter.
- Throttle/EGR valve and gear position sensor.
- Height & suspension sensor.
- Non-contacting potentiometer.
- Float-level sensor.
- Motor-shaft position sensor.
- Precision robotics, material handling, industrial equipment, HVAC monitoring & control, etc.



Magnetic rotary angle and position sensor-control.

Contactless sensor. MTS-360

How to order.

Simple output (analog / PWM)

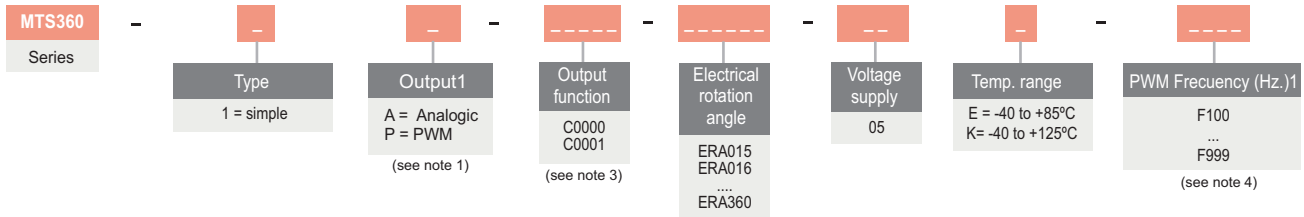

Simple output (SPI)

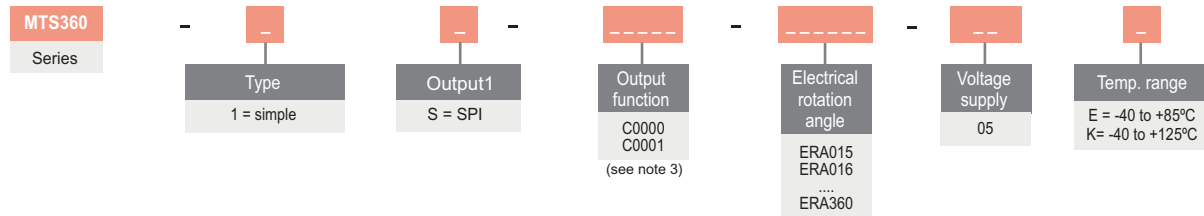

Redundant output (analog / PWM)

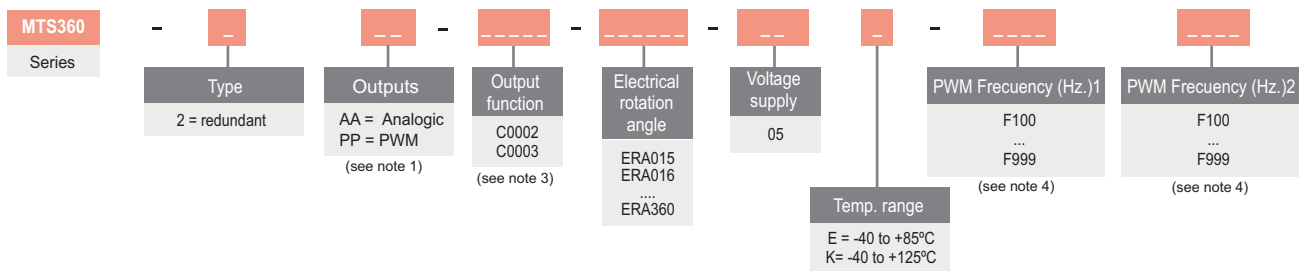

Redundant output (SPI)

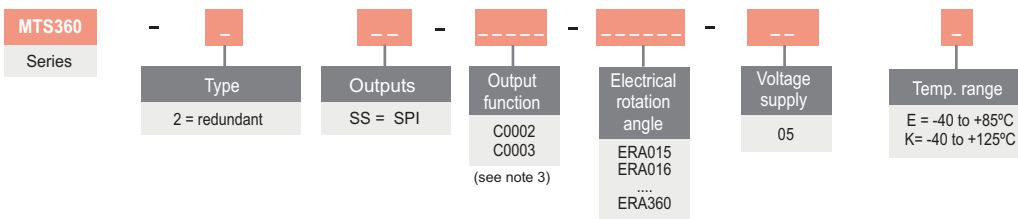

Other product configurations will be studied case by case.

(1) The analog output is a ratiometric output, proportional to input supply voltage.

(2) Leave empty if no applicable.

Switch function diagram:



(3) Other output functions available check availability. In the How To Order reference, enter **CXXXX** meanwhile the new output function reference is not defined.

(4) Leave empty if no applicable. Default frequency is 200 Hz

Notes

Piher Sensors & Controls SA

Our product competencies and services:
Potentiometers | Position / angle sensors | Rotary switches | Incremental encoders
Printed circuit resistors | Mechatronics | Value added assemblies

MEGGITT
smart engineering for
extreme environments

Magnetic rotary angle and position sensor-control.

Contactless sensor. MTS-360

Options.

- Special outputs slopes and protocols.
- Full redundant version with switches.
- Energy harvesting versions.
- Fast versions.
- Connectors.
- IP sealing.
- Shaft interfaces.
- Contact the factory for other options.

Dimensions.

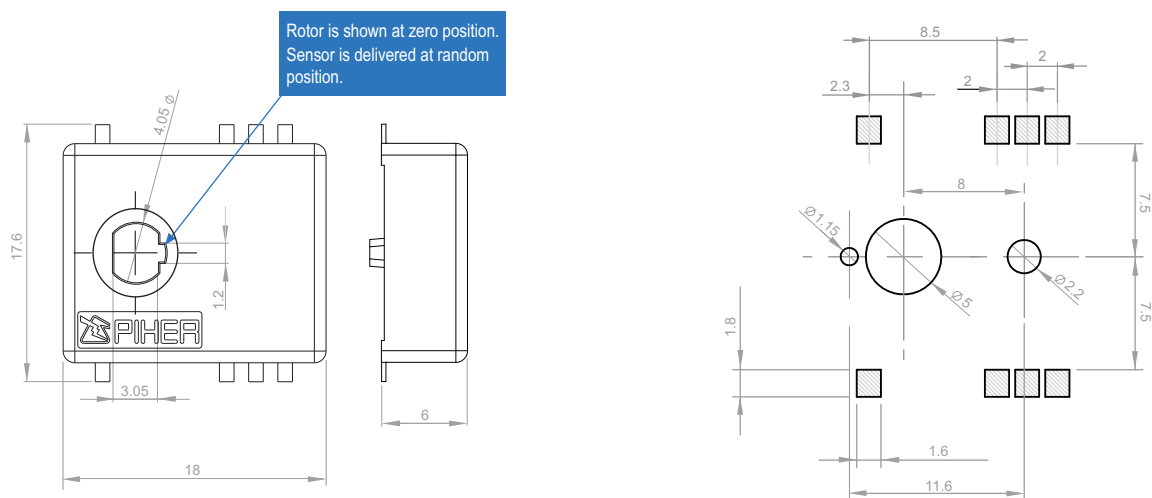

Recommended shaft.

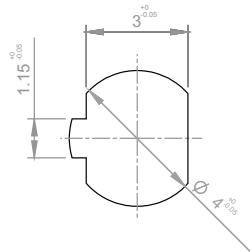

Piher Sensors & Controls SA

Our product competencies and services:
Potentiometers | Position / angle sensors | Rotary switches | Incremental encoders
Printed circuit resistors | Mechatronics | Value added assemblies

MEGGITT
smart engineering for
extreme environments



Magnetic rotary angle and position sensor-control.

Contactless sensor. MTS-360

Mounting instructions.



Electronic semiconductor products are sensitive to Electro Static Discharge (ESD).
Always observe Electro Static Discharge control procedures whenever handling semiconductor products.

Recommended reflow profile.

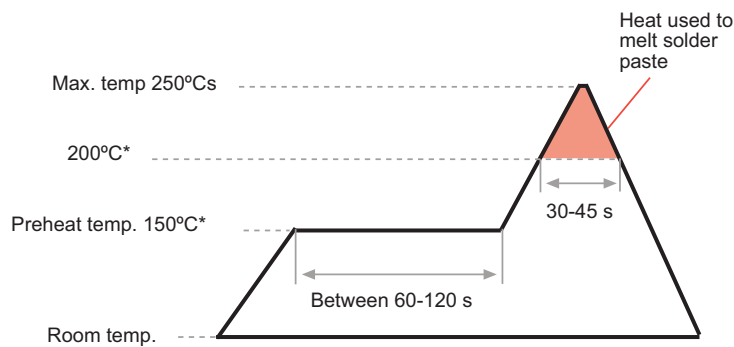

* Melting point temp. depends on solder properties

The recommended reflow profile is provided as a guideline. Optimal profile may differ due to oven type, assembly layout or other design or process variables. Customers should verify actual device performance in their specific application and reflow process. Please contact Piher if you require additional support.

Connections scheme.

Simple analog output version connection scheme.

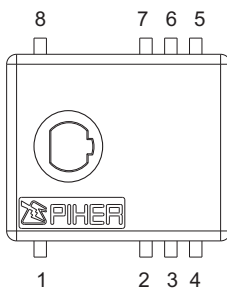

Pin	Description
1	Supply voltage
2	Supply voltage
3	Switch output*
4	Switch output*
5	Signal output**
6	Signal output**
7	Ground
8	Ground

* If the feature is not used in the application, please connect to ground

** Piher can supply the recommended wiring diagram

Piher Sensors & Controls SA

Our product competencies and services:
Potentiometers | Position / angle sensors | Rotary switches | Incremental encoders
Printed circuit resistors | Mechatronics | Value added assemblies



Magnetic rotary angle and position sensor-control.

Contactless sensor. MTS-360

Output.

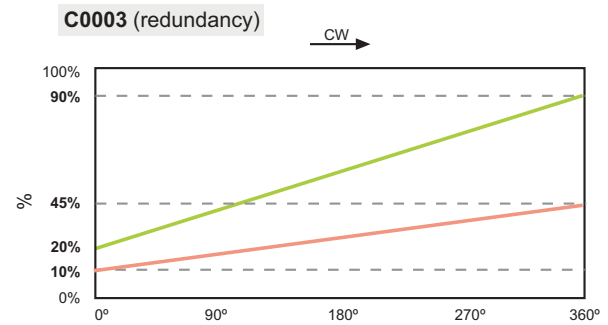
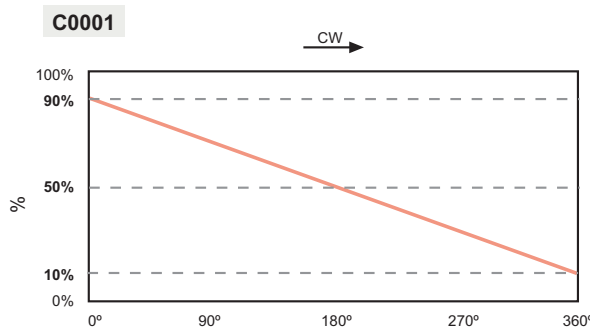
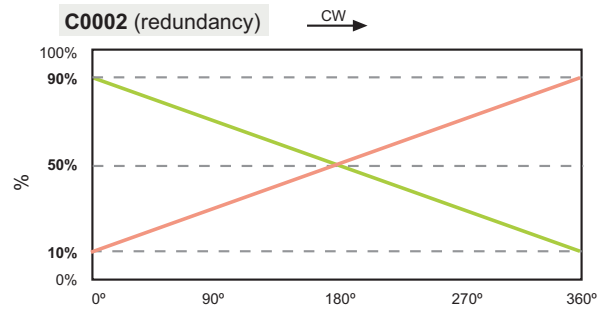
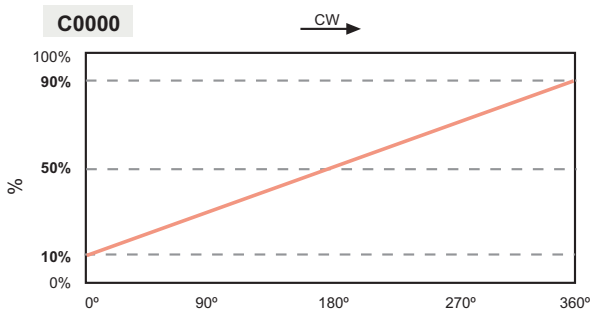

Disclaimer

The product information in this catalogue is for reference purposes. Please consult for the most up to date and accurate design information.

Piher Sensors & Controls S.A., its affiliates, agents, and employees, and all persons acting on its or their behalf (collectively, "Piher"), disclaim any and all liability for any errors, inaccuracies or incompleteness contained herein or in any other disclosure relating to any product described herein.

Piher disclaims any and all liability arising out of the use or application of any product described herein or of any information provided herein to the maximum extent permitted by law. The product specifications do not expand or otherwise modify Piher's terms and conditions of sale, including but not limited to the warranty expressed therein, which apply to these products.

No licence, express or implied, by estoppel or otherwise, to any intellectual property rights is granted by this document or by any conduct of Piher.

The products shown herein are not designed for use in medical, life-saving, or life-sustaining applications unless otherwise expressly indicated. Customers using or selling Piher products not expressly indicated for use in such applications do so entirely at their own risk and agree to fully indemnify Piher for any damages arising or resulting from such use or sale. Please contact authorised Piher personnel to obtain written terms and conditions regarding products designed for such applications.

Product names and markings noted herein may be trademarks of their respective owners.

Information contained in and/or attached to this catalogue may be subject to export control regulations of the European Community, USA, or other countries. Each recipient of this document is responsible to ensure that usage and/or transfer of any information contained in this document complies with all relevant export control regulations. If you are in any doubt about the export control restrictions that apply to this information, please contact the sender immediately. For any Piher International Corp. Exports, Note: All products / technologies are EAR99 Classified commodities. Exports from the United States are in accordance with the Export Administration Regulations. Diversion contrary to US law is prohibited.



Note: All Piher products can be adapted to meet customer's requirements.
Due to continuous process improvement, specifications are subject to change without notice.
Please always use the datasheets published at our website www.piher.net for the most up-to-date information.

v080716

Piher Sensors & Controls SA

Our product competencies and services:
Potentiometers | Position / angle sensors | Rotary switches | Incremental encoders
Printed circuit resistors | Mechatronics | Value added assemblies

Contact

piher.sales@meggitt.com

www.piher.net
www.meggitt.com

MEGGITT
smart engineering for
extreme environments

Mouser Electronics

Authorized Distributor

Click to View Pricing, Inventory, Delivery & Lifecycle Information:

[Piher:](#)

[MTS360-1A-W-360-0000-E](#) [MTS-360-1S-C0006-ERA360-05E](#) [MTS-360-1A-C0006-ERA060-05E](#) [MTS-360-1A-C0000-ERA360-05E](#) [MTS-360-1S-C0006-ERA060-05E](#)