

# Propeller™ P8X32A Datasheet

## 8-Cog Multiprocessor Microcontroller

### 1.0 PRODUCT OVERVIEW

#### 1.1. Introduction

The Propeller chip is designed to provide high-speed processing for embedded systems while maintaining low current consumption and a small physical footprint. In addition to being fast, the Propeller chip provides flexibility and power through its eight processors, called cogs, that can perform simultaneous tasks independently or cooperatively, all while maintaining a relatively simple architecture that is easy to learn and utilize. Two programming languages are available: Spin (a high-level object-based language) and Propeller Assembly. Both include custom commands to easily manage the Propeller chip's unique features.

Figure 1: Propeller P8X32A Block Diagram

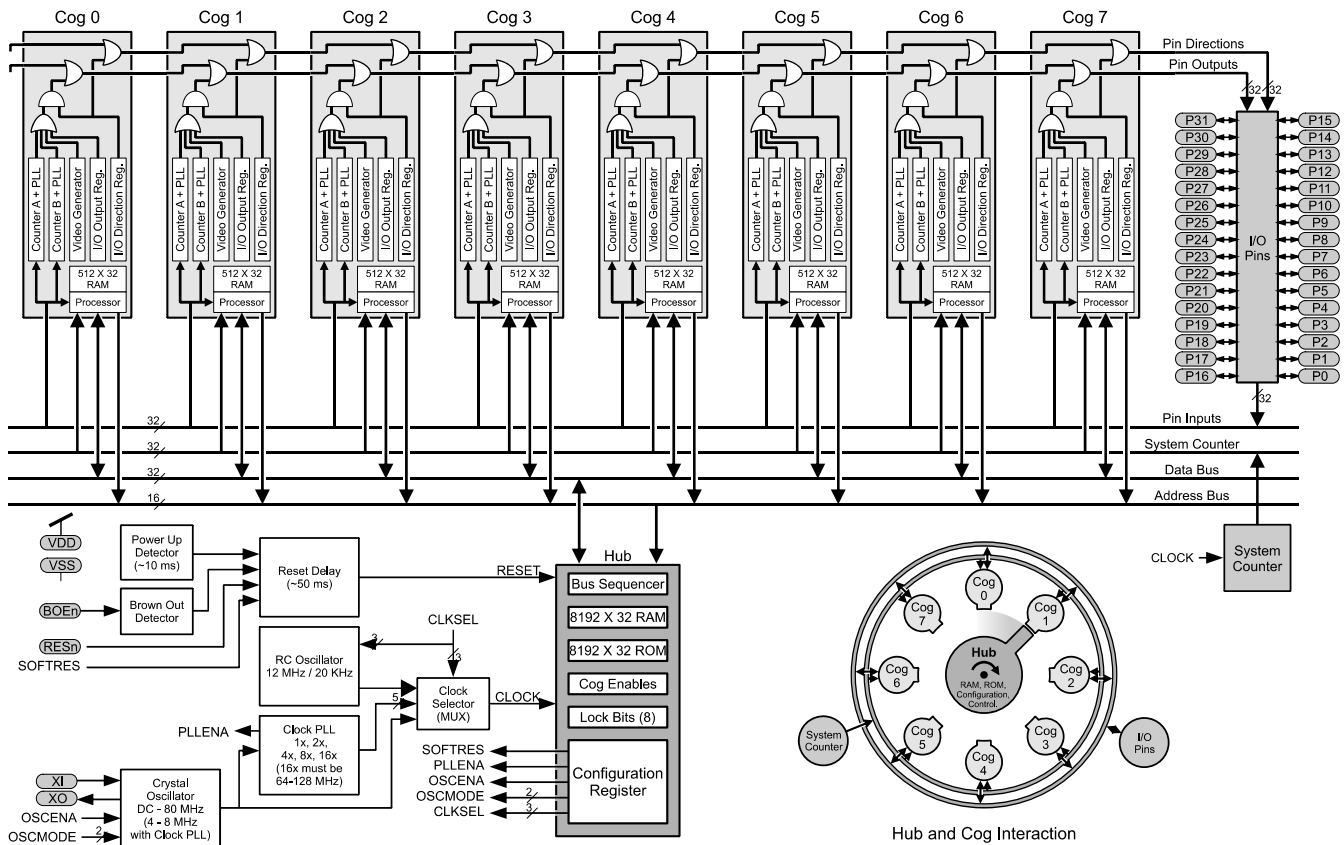

#### 1.2. Stock Codes

Table 1: Propeller Chip Stock Codes

Device Stock #	Package Type	I/O Pins	Power Requirements	External Clock Speed	Internal RC Oscillator	Internal Execution Speed	Global ROM/RAM	Cog RAM
P8X32A-D40	40-pin DIP	32 CMOS	3.3 volts DC	DC to 80 MHz	12 MHz or 20 kHz*	0 to 160 MIPS (20 MIPS/cog)	64 K bytes; 32768 bytes ROM / 32768 bytes RAM	512 x 32 bits per cog
P8X32A-Q44	44-pin LQFP							
P8X32A-M44	44-pin QFN							

\*Approximate; may range from 8 MHz – 20 MHz, or 13 kHz – 33 kHz, respectively.

**Table of Contents**

<b>1.0</b>	<b>Product Overview</b> .....	<b>1</b>	5.2.	Cog RAM.....	16
1.1.	Introduction.....	1	<b>6.0</b>	<b>Programming Languages</b> .....	<b>17</b>
1.2.	Stock Codes.....	1	6.1.	Reserved Word List.....	17
1.3.	Key Features and Benefits.....	3	6.1.1.	Words Reserved for Future Use.....	17
1.3.1.	32-bit Multicore Architecture.....	3	6.2.	Math and Logic Operators.....	18
1.3.2.	Clock System and Wait Instructions.....	3	6.3.	Spin Language Summary Table.....	19
1.3.3.	Programming Languages and Resources.....	3	6.3.1.	Constants.....	21
1.3.4.	Flexible I/O and Peripheral Interface.....	3	6.4.	Propeller Assembly Instruction Table.....	22
1.4.	Applications.....	3	6.4.1.	Assembly Conditions.....	24
1.4.1.	Corporate and Community Support.....	3	6.4.2.	Assembly Directives.....	24
<b>2.0</b>	<b>Connection Diagrams</b> .....	<b>4</b>	6.4.3.	Assembly Effects.....	24
2.1.	Pin Assignments.....	4	6.4.4.	Assembly Operators.....	24
2.2.	Pin Descriptions.....	4	<b>7.0</b>	<b>Electrical Characteristics</b> .....	<b>25</b>
2.3.	Typical Connection Diagrams.....	5	7.1.	Absolute Maximum Ratings.....	25
2.3.1.	Propeller Clip or Propeller Plug Connection - Recommended.....	5	7.2.	DC Characteristics.....	25
2.3.2.	Alternative Serial Port Connection.....	5	7.3.	AC Characteristics.....	25
<b>3.0</b>	<b>Operating Procedures</b> .....	<b>6</b>	<b>8.0</b>	<b>Current Consumption Characteristics</b> .....	<b>26</b>
3.1.	Boot-Up Procedure.....	6	8.1.	Typical Current Consumption of 8 Cogs.....	26
3.2.	Run-Time Procedure.....	6	8.2.	Typical Current of a Cog vs. Operating Frequency.....	27
3.3.	Shutdown Procedure.....	6	8.3.	Typical PLL Current vs. VCO Frequency.....	27
<b>4.0</b>	<b>System Organization</b> .....	<b>6</b>	8.4.	Typical Crystal Drive Current.....	28
4.1.	Shared Resources.....	6	8.5.	Cog and I/O Pin Relationship.....	28
4.2.	System Clock.....	6	8.6.	Current Profile at Various Startup Conditions.....	29
4.3.	Cogs (processors).....	7	<b>9.0</b>	<b>Temperature Characteristics</b> .....	<b>30</b>
4.4.	Hub.....	7	9.1.	Internal Oscillator Frequency as a Function of Temperature.....	30
4.5.	I/O Pins.....	8	9.2.	Fastest Operating Frequency as a Function of Temperature... ..	31
4.6.	System Counter.....	8	9.3.	Current Consumption as a Function of Temperature.....	32
4.7.	Locks.....	8	<b>10.0</b>	<b>Package Dimensions</b> .....	<b>33</b>
4.8.	Assembly Instruction Execution Stages.....	9	10.1.	P8X32A-D40 (40-pin DIP).....	33
4.9.	Cog Counters.....	10	10.2.	P8X32A-Q44 (44-pin LQFP).....	34
4.9.1.	CTRA / CTRB – Control register.....	10	10.3.	P8X32A-M44 (44-pin QFN).....	35
4.9.2.	FRQA / FRQB – Frequency register.....	10	<b>11.0</b>	<b>Manufacturing Info</b> .....	<b>36</b>
4.9.3.	PHSA / PHSB – Phase register.....	10	11.1.	Reflow Peak Temperature.....	36
4.10.	Video Generator.....	11	11.2.	Green/RoHS Compliance.....	36
4.10.1.	VCFG – Video Configuration Register.....	11	<b>12.0</b>	<b>Revision History</b> .....	<b>36</b>
4.10.2.	VSCL – Video Scale Register.....	12	12.1.1.	Changes for Version 1.1:.....	36
4.10.3.	WAITVID Command/Instruction.....	12	12.1.2.	Changes for Version 1.2:.....	36
4.11.	CLK Register.....	14	12.1.3.	Changes for Version 1.3:.....	36
<b>5.0</b>	<b>Memory Organization</b> .....	<b>15</b>	12.1.4.	Changes for Version 1.4.....	36
5.1.	Main Memory.....	15			
5.1.1.	Main RAM.....	15			
5.1.2.	Main ROM.....	15			
5.1.3.	Character Definitions.....	15			
5.1.4.	Math Function Tables.....	16			

### 1.3. Key Features and Benefits

The P8X32A design frees developers from common complexities of embedded systems programming.

#### 1.3.1. 32-bit Multicore Architecture

- True parallel processing with eight symmetric 32-bit processors (cogs) in one microcontroller
- Multi-cog run-time management (run/wait/stop) easily solves event-handling problems and eliminates the need for interrupts. This greatly simplifies programming for asynchronous and synchronous events, resulting in a responsive and easily maintained application.
- 20 MIPS per cog, 160 MIPS total with all cogs running
- Solves mixed-bandwidth needs common to embedded applications
- Multi-purpose design lowers part count while increasing system capabilities
- Developer-driven cog assignments bring flexible response and deterministic timing to embedded applications

#### 1.3.2. Clock System and Wait Instructions

- Flexible Clock Modes
  - Two internal, one external, plus optional 1x–16x PLL; up to 80 MHz system clock
  - Switchable in code at run-time; low frequency for low-power periods, high frequency for high-bandwidth moments
- Shared System Clock facilitates synchronization between cogs
- WAIT Instructions
  - Deliver powerful synchronous / asynchronous event management
  - Set dedicated event cogs to an "always ready," very low power state

#### 1.3.3. Programming Languages and Resources

- Spin (object-based, high-level) and Assembly (PASM; low-level); used together for thorough development, i.e. fast development in Spin plus fast execution with prewritten high-speed PASM drivers
- Third-party support: C, BASIC, and more
- Enhanced Assembly Language
  - Conditional execution for individual instructions; enables jitter-free signal generation and event handling
  - Optional flag and result writing for individual instructions
- Open-source Objects
  - Objects are shared freely via the Propeller Object Exchange and Propeller Tool libraries
  - Select objects that fit a need, easily integrate them into a Propeller application

#### 1.3.4. Flexible I/O and Peripheral Interface

- 32 I/O Pins
  - All general-purpose I/O after boot-up; accessible by every cog simultaneously
  - Single-instruction access to any individual I/O pin or any contiguous I/O pin group
  - Easily move designed functions between pins for simple system board layout
- Multi-function Counters
  - Configurable state machines generate or sense repetitive signals per clock cycle
  - Measure frequency, detect edges, count cycles, D/A or A/D conversion, and more
  - Operate autonomously with optional run-time monitoring and adjusting
  - Two counters per cog
- Video Generators
  - RGB: VGA; 8 I/O pins
  - Composite: NTSC, PAL; 1-pin (B/W), 3-pin (typical), or 4-pin (optional)
  - One generator per cog
- Software Peripherals
  - Peripheral interfaces built with software and inexpensive passive components; not single-function on-chip hardware
  - Software-based interfaces are flexible; enhance as peripheral needs arise — no need to redesign with a chip variant

### 1.4. Applications

The P8X32A is particularly useful in projects that can be vastly simplified with simultaneous processing, including:

- Industrial control systems
- Sensor integration, signal processing, and data acquisition
- Handheld portable human-interface terminals
- Motor and actuator control
- User interfaces requiring NTSC, PAL, or VGA output, with PS/2 keyboard and mouse input
- Low-cost video game systems
- Industrial, educational or personal-use robotics
- Wireless video transmission (NTSC or PAL)

#### 1.4.1. Corporate and Community Support

- Sales or technical support: (916) 632-4664
- Email sales: [sales@parallaxsemiconductor.com](mailto:sales@parallaxsemiconductor.com)
- Email support: [support@parallaxsemiconductor.com](mailto:support@parallaxsemiconductor.com)
- Engineer-moderated Parallax Semiconductor sub-forum is available from <http://forums.parallax.com>
- Parallax-hosted Propeller Object Exchange library: <http://obex.parallax.com>

## 2.0 CONNECTION DIAGRAMS

### 2.1. Pin Assignments

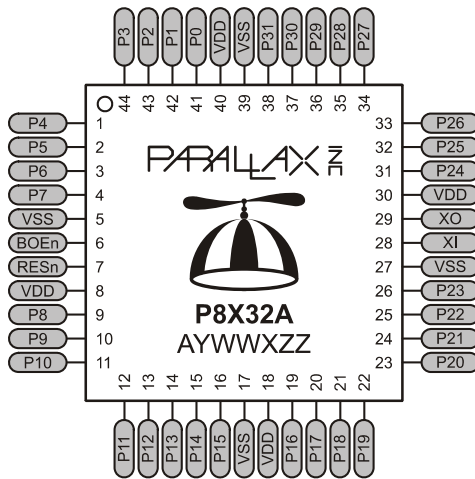

LQFP and QFN Packages

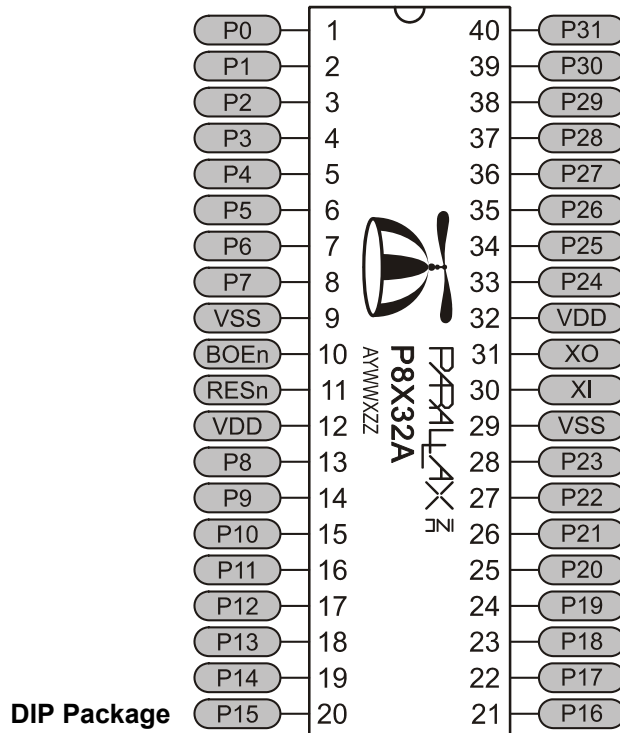

DIP Package

### 2.2. Pin Descriptions

Table 2: Pin Descriptions		
Pin Name	Direction	Description
P0 – P31	I/O	General purpose I/O Port A. Can source/sink 40 mA each at 3.3 VDC. CMOS level logic with threshold of $\approx \frac{1}{2}$ VDD or 1.6 VDC @ 3.3 VDC.  The pins shown below have a special purpose upon power-up/reset but are general purpose I/O afterwards. P28 - I2C SCL connection to optional, external EEPROM. P29 - I2C SDA connection to optional, external EEPROM. P30 - Serial Tx to host. P31 - Serial Rx from host.
VDD	---	3.3 volt power (2.7 – 3.6 VDC)
VSS	---	Ground
BOEn	I	Brown Out Enable (active low). Must be connected to either VDD or VSS. If low, RESn becomes a weak output (delivering VDD through 5 kΩ) for monitoring purposes but can still be driven low to cause reset. If high, RESn is CMOS input with Schmitt Trigger.
RESn	I/O	Reset (active low). When low, resets the Propeller chip: all cogs disabled and I/O pins floating. Propeller restarts 50 ms after RESn transitions from low to high.
XI	I	Crystal Input. Can be connected to output of crystal/oscillator pack (with XO left disconnected), or to one leg of crystal (with XO connected to other leg of crystal or resonator) depending on CLK Register settings. No external resistors or capacitors are required.
XO	O	Crystal Output. Provides feedback for an external crystal, or may be left disconnected depending on CLK Register settings. No external resistors or capacitors are required.

### 2.3. Typical Connection Diagrams

#### 2.3.1. Propeller Clip or Propeller Plug Connection - Recommended

Note that the connections to the external oscillator and EEPROM, which are enclosed in dashed lines, are optional.

Propeller Clip, Stock #32200; Propeller Plug, Stock #32201. The Propeller Clip/Plug schematic is available for download from [www.parallax.com](http://www.parallax.com).

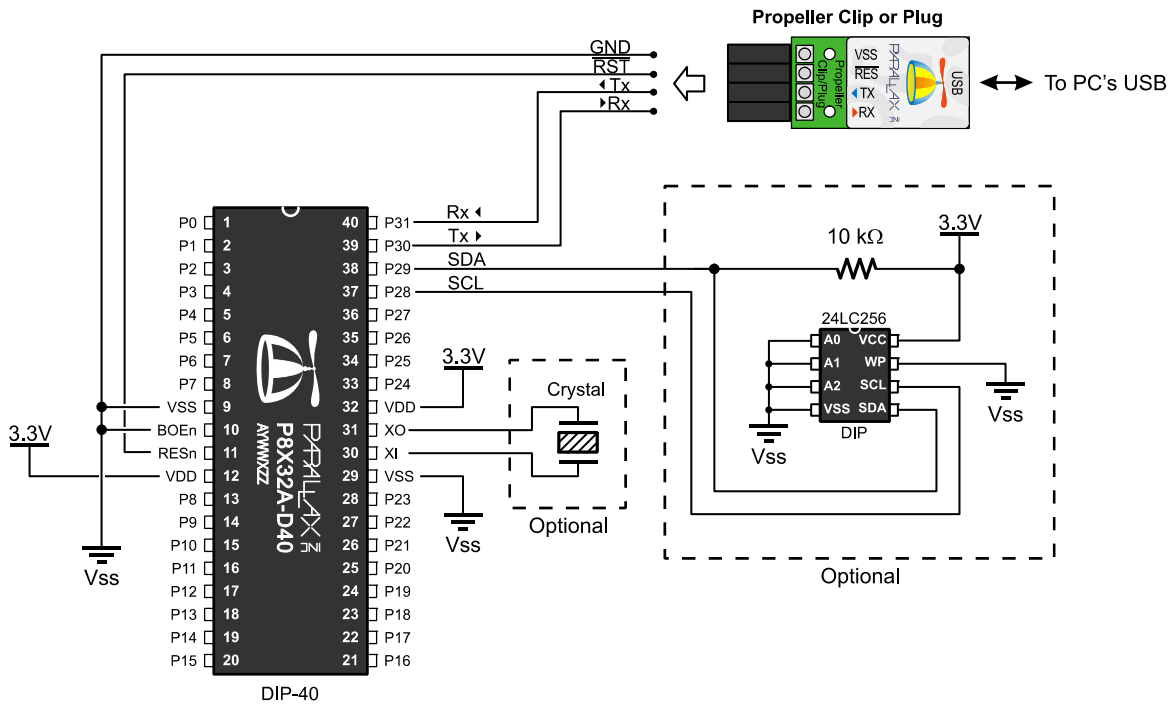

#### 2.3.2. Alternative Serial Port Connection

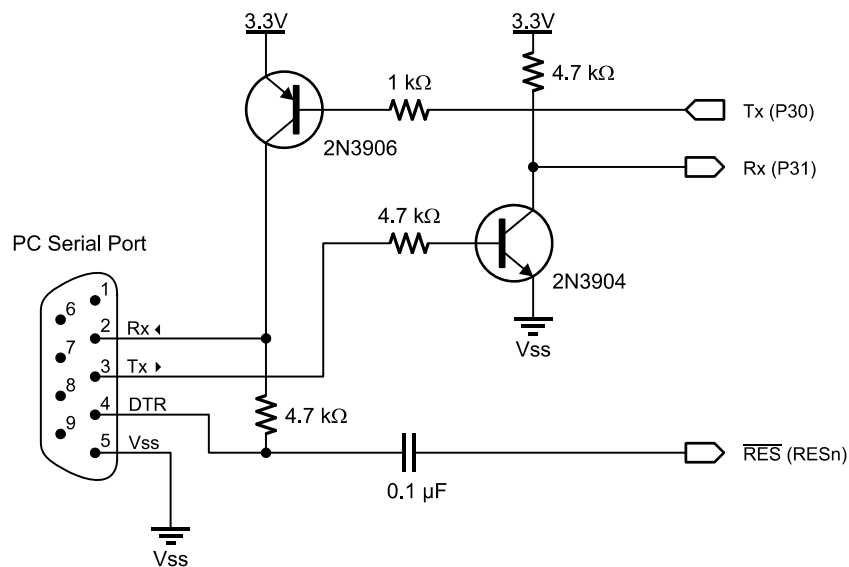

## 3.0 OPERATING PROCEDURES

### 3.1 Boot-Up Procedure

Upon power-up, or reset:

1. The Propeller chip's internal RC oscillator begins running at 20 kHz, then after a 50 ms reset delay, switches to 12 MHz. Then the first processor (Cog 0) loads and runs the built-in Boot Loader program.
2. The Boot Loader performs one or more of the following tasks, in order:
  - a. Detects communication from a host, such as a PC, on pins P30 and P31. If communication from a host is detected, the Boot Loader converses with the host to identify the Propeller chip and possibly download a program into global RAM and optionally into an external 32 KB EEPROM.
  - b. If no host communication was detected, the Boot Loader looks for an external 32 KB EEPROM on pins P28 and P29. If an EEPROM is detected, the entire 32 KB data image is loaded into the Propeller chip's global RAM.
  - c. If no EEPROM was detected, the boot loader stops, Cog 0 is terminated, the Propeller chip goes into shutdown mode, and all I/O pins are set to inputs.
3. If either step 2a or 2b was successful in loading a program into the global RAM, and a suspend command was not given by the host, then Cog 0 is reloaded with the built-in Spin Interpreter and the user code is run from global RAM.

### 3.2 Run-Time Procedure

A Propeller Application is a user program compiled into its binary form and downloaded to the Propeller chip's RAM or external EEPROM. The application consists of code written in the Propeller chip's Spin language (high-level code) with optional Propeller Assembly language components (low-level code). Code written in the Spin language is interpreted during run time by a cog running the Spin Interpreter while code written in Propeller Assembly is run in its pure form directly by a cog. Every Propeller Application consists of at least a little Spin code and may actually be written entirely in Spin or with various amounts of Spin and assembly. The Propeller chip's Spin Interpreter is started in Step 3 of the Boot Up Procedure, above, to get the application running.

Once the boot-up procedure is complete and an application is running in Cog 0, all further activity is defined by the application itself. The application has complete control over things like the internal clock speed,

I/O pin usage, configuration registers, and when, what and how many cogs are running at any given time. All of this is variable at run time, as controlled by the application.

### 3.3 Shutdown Procedure

When the Propeller goes into shutdown mode, the internal clock is stopped causing all cogs to halt and all I/O pins are set to input direction (high impedance). Shutdown mode is triggered by one of the three following events:

1. VDD falling below the brown-out threshold (~2.7 VDC), when the brown out circuit is enabled,
2. the RESn pin going low, or
3. the application requests a reboot (see the **REBOOT** command in the Propeller Manual).

Shutdown mode is discontinued when the voltage level rises above the brown-out threshold and the RESn pin is high.

## 4.0 SYSTEM ORGANIZATION

### 4.1 Shared Resources

There are two types of shared resources in the Propeller: 1) common, and 2) mutually-exclusive. Common resources can be accessed at any time by any number of cogs. Mutually-exclusive resources can also be accessed by any number of cogs, but only by one cog at a time. The common resources are the I/O pins and the System Counter. All other shared resources are mutually-exclusive by nature and access to them is controlled by the Hub. See Section 4.4 on page 7.

### 4.2 System Clock

The System Clock (shown as "CLOCK" in Figure 1, page 1) is the central clock source for nearly every component of the Propeller chip. The System Clock's signal comes from one of three possible sources:

- The internal RC oscillator (~12 MHz or ~20 kHz)
- The XI input pin (either functioning as a high-impedance input or a crystal oscillator in conjunction with the XO pin)
- The Clock PLL (phase-locked loop) fed by the XI input

The source is determined by the CLK register's settings, which is selectable at compile time and reselectable at run time. The Hub and internal Bus operate at half the System Clock speed.

### 4.3. Cogs (processors)

The Propeller contains eight (8) identical, independent processors, called cogs, numbered 0 to 7. Each cog contains a Processor block, local 2 KB RAM configured as 512 longs (512 x 32 bits), two advanced counter modules with PLLs, a Video Generator, I/O Output Register, I/O Direction Register, and other registers not shown in the Block Diagram.

All eight cogs are driven from the System Clock; they each maintain the same time reference and all active cogs execute instructions simultaneously. They also all have access to the same shared resources.

Cogs can be started and stopped at run time and can be programmed to perform tasks simultaneously, either independently or with coordination from other cogs through Main RAM. Each cog has its own RAM, called Cog RAM, which contains 512 registers of 32 bits each. The Cog RAM is all general purpose RAM except for the last 16 registers, which are special purpose registers, as described in Table 15 on page 16.

### 4.4. Hub

To maintain system integrity, mutually-exclusive resources must not be accessed by more than one cog at a time. The Hub controls access to mutually-exclusive resources by giving each cog a turn in a “round robin” fashion from Cog 0 through Cog 7 and back to Cog 0 again. The Hub and its bus run at half the System Clock rate, giving a cog access to mutually-exclusive resources once every 16 System Clock cycles. Hub instructions, the Propeller Assembly instructions that access mutually-exclusive resources, require 8 cycles to execute but they first need to be synchronized to the start of the Hub Access Window.

It takes up to 15 cycles (16 minus 1, if we just missed it) to synchronize to the Hub Access Window plus 8 cycles to execute the hub instruction, so hub instructions take from 8 to 23 cycles to complete.

Figure 2 and Figure 3 show examples where Cog 0 has a hub instruction to execute. Figure 2 shows the best-case scenario; the hub instruction was ready right at the start of that cog’s access window. The hub instruction executes immediately (8 cycles) leaving an additional 8 cycles for other instructions before the next Hub Access Window arrives.

Figure 3 shows the worst-case scenario; the hub instruction was ready on the cycle right after the start of Cog 0’s access window; it just barely missed it. The cog waits until the next Hub Access Window (15 cycles later) then the hub instruction executes (8 cycles) for a total of 23 cycles for that hub instruction. Again, there are 8 additional cycles after the hub instruction for other instructions to execute before the next Hub Access Window arrives. To get the most efficiency out of Propeller Assembly routines that have to frequently access mutually-exclusive resources, it can be beneficial to interleave non-hub instructions with hub instructions to lessen the number of cycles waiting for the next Hub Access Window. Since most Propeller Assembly instructions take 4 clock cycles, two such instructions can be executed in between otherwise contiguous hub instructions.

Keep in mind that a particular cog’s hub instructions do not, in any way, interfere with other cogs’ instructions because of the Hub mechanism. Cog 1, for example, may start a hub instruction during System Clock cycle 2, in both of these examples, possibly overlapping its execution with that of Cog 0 without any ill effects. Meanwhile, all other cogs can continue executing non-hub instructions, or awaiting their individual hub access windows regardless of what the others are doing.

**Figure 2: Cog-Hub Interaction – Best Case Scenario**

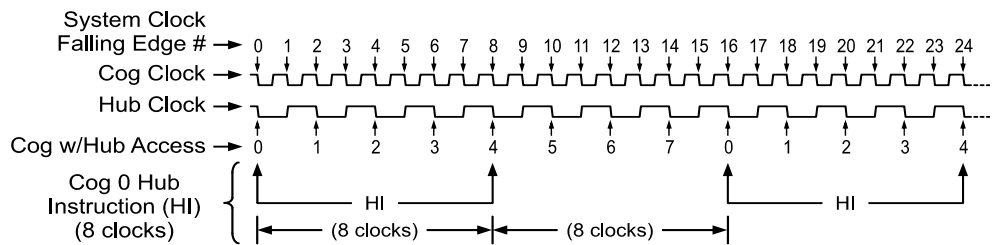

**Figure 3: Cog-Hub Interaction – Worst Case Scenario**

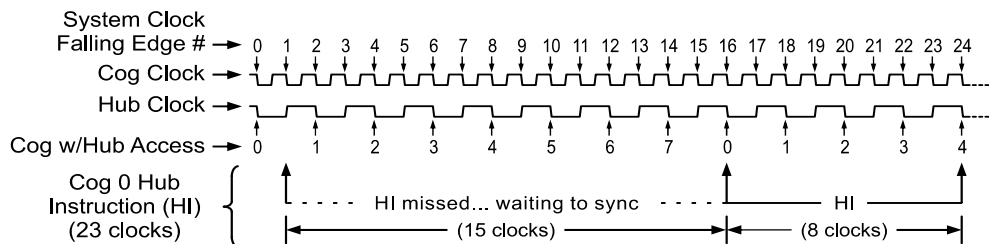

### 4.5. I/O Pins

The Propeller has 32 I/O pins, 28 of which are general purpose. I/O Pins 28 - 31 have a special purpose at boot up and are available for general purpose use afterwards; see section 2.2, page 4. After boot up, any I/O pins can be used by any cogs at any time. It is up to the application developer to ensure that no two cogs try to use the same I/O pin for different purposes during run time.

Refer to Figure 1, page 1. Each cog has its own 32-bit I/O Direction Register and 32-bit I/O Output Register to influence the states of the Propeller chip's corresponding 32 I/O pins. A cog's desired I/O directions and output states is communicated through the entire cog collective to become "Pin Directions" and "Pin Outputs."

Pin Directions are the result of OR'ing the Direction Registers of the cogs together. Pin Outputs are the result of OR'ing the output states of the cogs together. A cog's output state consists of the bits of its I/O modules (the Counters, the Video Generator, and the I/O Output Register) OR'd together then AND'd with the bits of its Direction Register. All cogs can still access and influence the I/O pins simultaneously, without electrical contention,

as described by these rules:

- A. A pin is an input only if no active cog sets it to an output.
- B. A pin outputs low only if all active cogs that set it to output also set it to low.
- C. A pin outputs high if any active cog sets it to an output and also sets it high.

Table 3 demonstrates a few possible combinations of the collective cogs' influence on a particular I/O pin, P12 in this example. For simplification, these examples assume that bit 12 of each cog's I/O hardware, other than its I/O Output Register, is cleared to zero (0).

Any cog that is shut down has its Direction Register and output states cleared to zero, effectively removing it from influencing the final state of the I/O pins that the remaining active cogs are controlling.

Each cog also has its own 32-bit Input Register. This input register is really a pseudo-register; every time it is read, the actual states of the I/O pins are read, regardless of their input or output direction.

**Table 3: I/O Sharing Examples**

Cog ID	Bit 12 of Cogs' I/O Direction Register	Bit 12 of Cogs' I/O Output Register	State of I/O Pin P12	Rule Followed
	0 1 2 3 4 5 6 7	0 1 2 3 4 5 6 7		
Example 1	0 0 0 0 0 0 0 0	0 0 0 0 0 0 0 0	Input	A
Example 2	1 0 0 0 0 0 0 0	0 0 0 0 0 0 0 0	Output Low	B
Example 3	1 0 0 0 0 0 0 0	1 0 0 0 0 0 0 0	Output High	C
Example 4	1 0 0 0 0 0 0 0	0 1 0 0 0 0 0 0	Output Low	B
Example 5	1 1 0 0 0 0 0 0	0 1 0 0 0 0 0 0	Output High	C
Example 6	1 1 1 1 1 1 1 1	0 1 0 1 0 0 0 0	Output High	C
Example 7	1 1 1 1 1 1 1 1	0 0 0 1 0 0 0 0	Output High	C
Example 8	1 1 1 0 1 1 1 1	0 0 0 1 0 0 0 0	Output Low	B

**Note:** For the I/O Direction Register, a 1 in a bit location sets the corresponding I/O pin to the output direction; a 0 sets it to an input direction.

### 4.6. System Counter

The System Counter is a global, read-only, 32-bit counter that increments once every System Clock cycle. Cogs can read the System Counter (via their CNT registers, see Table 15 on page 16) to perform timing calculations and can use the WAITCNT command (see section 6.3 on page 19 and section 6.4 on page 22) to create effective delays within their processes. The System Counter is a common resource which every cog can read simultaneously. The System Counter is not cleared upon startup since its practical use is for differential timing. If a cog needs to keep track of time from a specific, fixed moment in time, it simply needs to read and save the initial counter value at that moment in time, and compare subsequent counter values against that initial value.

### 4.7. Locks

There are eight lock bits (semaphores) available to facilitate exclusive access to user-defined resources among multiple cogs. If a block of memory is to be used by two or more cogs at once and that block consists of more than one long (four bytes), the cogs will each have to perform multiple reads and writes to retrieve or update that memory block. This leads to the likely possibility of read/write contention on that memory block where one cog may be writing while another is reading, resulting in misreads and/or miswrites.

The locks are global bits accessed through the Hub via LOCKNEW, LOCKRET, LOCKSET, and LOCKCLR. Because locks are accessed only through the Hub, only one cog at a time can affect them, making this an effective control mechanism. The Hub maintains an inventory of which locks are in use and their current states; cogs can check out, return, set, and clear locks as needed during run time.



### 4.8. Assembly Instruction Execution Stages

Figure 4: Assembly Instruction Execution Stages

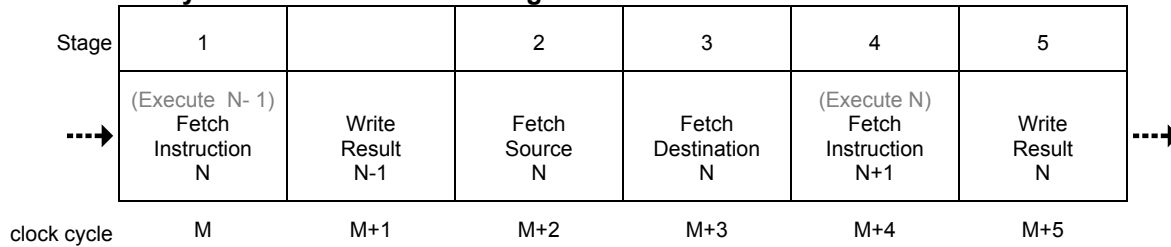

The Propeller executes assembly instructions in five stages. While an entire instruction takes six cycles to execute, two of those clock cycles are dedicated to the two adjacent instructions. This results in an overall throughput of four clock cycles per instruction.

accessed by instruction N. To speed up the throughput of program execution, the next instruction to be executed is fetched from cog memory while the current instruction is executed in the ALU.

Finally at clock cycle M+5 the result of the current instruction N is written back to cog memory, completing Stage 5.

The partial interleaving of instructions has a couple implications to program flow. First, when code modification occurs through **MOVI**, **MOVS**, **MOVD** or any operations which modifies an assembly instruction, there must be at least one instruction executed before the modified instruction is executed. If the modification is done on the immediately following instruction (N+1), the unmodified version of instruction N+1 will be loaded a clock cycle before the modified version of instruction N+1 is written to cog memory.

Figure 5  
Cog Memory

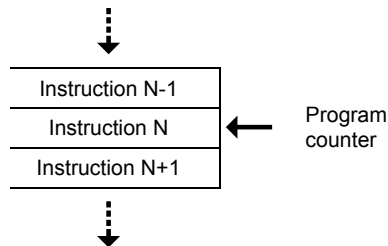

In Stage 1, instruction N, pointed to by the Program Counter, is fetched from cog memory during clock cycle M. During cycle M+1 the result from the previous instruction is written to memory. The reason the previous instruction result is written after the current instruction is fetched will be explained shortly.

Second, conditional jumps do not know for certain if they will jump until the end of clock cycle M+4. Since the next instruction has already been fetched, only one of the two possible branches can be predicted. In the Propeller, conditional branches are always predicted to take the jump. For loops using **DJNZ** where the jump is taken every time except the final loop, a tighter execution time of the loop is achieved.

During Stage 2, if the immediate flag of Instruction N is set, the 9 bit source field is saved as the source value. If the value is not immediate, the location specified by the source field is fetched from cog memory during clock cycle M+2. During clock cycle M+3 the location specified in the destination field is fetched from cog memory (Stage 3).

In the event the jump is not taken, the cog takes no action until the next instruction is fetched. This is equivalent to a **NOP** being inserted before the next instruction is executed. Unconditional jumps always take four clock cycles to execute since the Propeller can always accurately predict what address needs to be loaded into the Program Counter for the next instruction to execute. Examples of unconditional jumps include **JMP**, **JMPRET**, **CALL** and **RET**.

At this point in time (Stage 4) the Arithmetic Logic Unit (ALU) has all the information needed to execute the instruction. Executing the instruction takes some amount of time before the result is available. The amount of time required for execution is dictated by the slowest operation the ALU performs. To provide enough time for the ALU to execute the instruction, a full clock cycle (M+4) is provided to the ALU for the result to settle into its final state. During this execution, the cog memory is not

If an instruction needs to access any Hub resource, Stage 4 is extended until the Hub becomes available, increasing execution time to at least 8 and potentially up to 23 clock cycles. See Section 4.4: Hub on page 7.

## 4.9. Cog Counters

Each cog has two counter modules: **CTRA** and **CTRB**. Each counter module can control or monitor up to two I/O pins and perform conditional 32-bit accumulation of its FRQ register into its PHS register on every clock cycle.

Each counter module also has its own phase-locked loop (PLL) which can be used to synthesize frequencies up to 128 MHz.

With a little setup or oversight from the cog, a counter can be used for:

- frequency synthesis
- frequency measurement
- pulse counting
- pulse measurement
- multi-pin state measurement
- pulse-width modulation
- duty-cycle measurement
- digital-to-analog conversion
- analog-to-digital conversion

For some of these operations, the cog can be set up and left in a free-running mode. For others, it may use **WAITCNT** to time-align counter reads and writes within a loop, creating the effect of a more complex state machine.

Note that for a cog clock frequency of 80 MHz, the counter update period is a mere 12.5 ns. This high speed, combined with 32-bit precision, allows for very dynamic signal generation and measurement.

The design goal for the counter was to create a simple and flexible subsystem which could perform some repetitive task on every clock cycle, thereby freeing the cog to perform some computationally richer super-task. While the counters have only 32 basic operating modes, there is no limit to how they might be used dynamically through software. Integral to this concept is the use of the **WAITPEQ**, **WAITPNE**, and **WAITCNT** instructions, which can event-align or time-align a cog with its counters.

Each counter has three registers:

### 4.9.1. CTRA / CTRB – Control register

The CTR (CTRA and CTRB) register selects the counter's operating mode. As soon as this register is written, the new operating mode goes into effect. Writing a zero to CTR will immediately disable the counter, stopping all pin output and PHS accumulation.

31	30..26	25..23	22..15	14..9	8..6	5..0
-	CTRMODE	PLLDIV	-	BPIN	-	APIN

The CTRMODE field selects one of 32 operating modes for the counter, conveniently written (along with PLLDIV) using the **MOVI** instruction. These modes of operation are listed in Table 6 on page 11.

PLLDIV	%000	%001	%010	%011	%100	%101	%110	%111
Output	VCO 128	VCO 64	VCO 32	VCO 16	VCO 8	VCO 4	VCO 2	VCO 1

PLLDIV selects a PLL output tap and may be ignored if not used.

The PLL modes (%0001 to %0011) cause FRQ-to-PHS accumulation to occur every clock cycle. This creates a numerically-controlled oscillator (NCO) in PHS[31], which feeds the counter PLL's reference input. The PLL will multiply this frequency by 16 using its voltage-controlled oscillator (VCO). For stable operation, it is recommended that the VCO frequency be kept within 64 MHz to 128 MHz. This translates to an NCO frequency of 4 MHz to 8 MHz.

The PLLDIV field of the CTR register selects which power-of-two division of the VCO frequency will be used as the final PLL output. This affords a PLL range of 500 kHz to 128 MHz.

BPIN selects a pin to be the secondary I/O. It may be ignored if not used and may be written using the **MOVD** instruction.

APIN selects a pin to be the primary I/O. It may be ignored if not used and may be written using the **MOVS** instruction.

### 4.9.2. FRQA / FRQB – Frequency register

FRQ (FRQA and FRQB) holds the value that will be accumulated into the PHS register. For some applications, FRQ may be written once, and then ignored. For others, it may be rapidly modulated.

### 4.9.3. PHSA / PHSB – Phase register

The PHS (PHSA and PHSB) register can be written and read via cog instructions, but it also functions as a free-running accumulator, summing the FRQ register into itself on potentially every clock cycle. Any instruction writing to PHS will override any accumulation for that clock cycle. PHS can only be read through the source operand (same as PAR, CNT, INA, and INB). Beware that doing a read-modify-write instruction on PHS, like "ADD PHSA, #1", will cause the last-written value to be used as the destination operand input, rather than the current accumulation.

Table 6: Counter Modes (CTRMODE Field Values)				
CTRMODE	Description	Accumulate FRQx to PHSx	APIN Output*	BPIN Output*
%00000	Counter disabled (off)	0 (never)	0 (none)	0 (none)
%00001	PLL internal (video mode)	1 (always)	0	0
%00010	PLL single-ended	1	PLLx	0
%00011	PLL differential	1	PLLx	!PLLx
%00100	NCO single-ended	1	PHSx[31]	0
%00101	NCO differential	1	PHSx[31]	!PHSx[31]
%00110	DUTY single-ended	1	PHSx-Carry	0
%00111	DUTY differential	1	PHSx-Carry	!PHSx-Carry
%01000	POS detector	A <sup>1</sup>	0	0
%01001	POS detector with feedback	A <sup>1</sup>	0	!A1
%01010	POSEDGE detector	A <sup>1</sup> & !A <sup>2</sup>	0	0
%01011	POSEDGE detector w/ feedback	A <sup>1</sup> & !A <sup>2</sup>	0	!A1
%01100	NEG detector	!A <sup>1</sup>	0	0
%01101	NEG detector with feedback	!A <sup>1</sup>	0	!A1
%01110	NEGEDGE detector	!A <sup>1</sup> & A <sup>2</sup>	0	0
%01111	NEGEDGE detector w/ feedback	!A <sup>1</sup> & A <sup>2</sup>	0	!A1
%10000	LOGIC never	0	0	0
%10001	LOGIC !A & !B	!A <sup>1</sup> & !B <sup>1</sup>	0	0
%10010	LOGIC A & !B	A <sup>1</sup> & !B <sup>1</sup>	0	0
%10011	LOGIC !B	!B <sup>1</sup>	0	0
%10100	LOGIC !A & B	!A <sup>1</sup> & B <sup>1</sup>	0	0
%10101	LOGIC !A	!A <sup>1</sup>	0	0
%10110	LOGIC A <> B	A <sup>1</sup> <> B <sup>1</sup>	0	0
%10111	LOGIC !A   !B	!A <sup>1</sup>   !B <sup>1</sup>	0	0
%11000	LOGIC A & B	A <sup>1</sup> & B <sup>1</sup>	0	0
%11001	LOGIC A == B	A <sup>1</sup> == B <sup>1</sup>	0	0
%11010	LOGIC A	A <sup>1</sup>	0	0
%11011	LOGIC A   !B	A <sup>1</sup>   !B <sup>1</sup>	0	0
%11100	LOGIC B	B <sup>1</sup>	0	0
%11101	LOGIC !A   B	!A <sup>1</sup>   B <sup>1</sup>	0	0
%11110	LOGIC A   B	A <sup>1</sup>   B <sup>1</sup>	0	0
%11111	LOGIC always	1	0	0

\*Must set corresponding DIR bit to affect pin. A1 = APIN input delayed by 1 clock. A2 = APIN input delayed by 2 clocks. B1 = BPIN input delayed by 1 clock.

### 4.10. Video Generator

Each cog has a video generator module that facilitates transmitting video image data at a constant rate. There are two registers and one instruction which provide control and access to the video generator. Counter A of the cog must be running in a PLL mode and is used to generate the timing signal for the Video Generator. The Video Scale Register specifies the number of Counter A PLL (PLLA) clock cycles for each pixel and number of clock cycles before fetching another frame of data provided by the WAITVID instruction which is executed within the cog. The Video Configuration Register establishes the mode the Video Generator should operate, and can generate VGA or composite video (NTSC or PAL).

The Video Generator should be initialized by first starting Counter A, setting the Video Scale Register, setting the

Video Configuration Register, then finally providing data via the WAITVID instruction. Failure to properly initialize the Video Generator by first starting PLLA will cause the cog to indefinitely hang when the WAITVID instruction is executed.

#### 4.10.1. VCFG – Video Configuration Register

The Video Configuration Register contains the configuration settings of the video generator and is shown in Table 7.

In Propeller Assembly, the VMode through AuralSub fields can conveniently be written using the MOVI instruction, the VGroup field can be written with the MOVD instruction, and the VPins field can be written with the MOVS instruction.

Table 7: VCFG Register									
31	30..29	28	27	26	25..23	22..12	11..9	8	7..0
-	VMode	CMode	Chroma1	Chroma0	AuralSub	-	VGroup	-	VPins

The 2-bit VMode (video mode) field selects the type and orientation of video output, if any, according to Table 8.

Table 8: The Video Mode Field	
VMode	Video Mode
00	Disabled, no video generated.
01	VGA mode; 8-bit parallel output on VPins 7:0
10	Composite Mode 1; broadcast on VPins 7:4, baseband on VPins 3:0
11	Composite Mode 2; baseband on VPins 7:4, broadcast on VPins 3:0

The CMode (color mode) field selects two or four color mode. 0 = two-color mode; pixel data is 32 bits by 1 bit and only colors 0 or 1 are used. 1 = four-color mode; pixel data is 16 bits by 2 bits, and colors 0 through 3 are used.

The Chromal (broadcast chroma) bit enables or disables chroma (color) on the broadcast signal. 0 = disabled, 1 = enabled.

The Chroma0 (baseband chroma) bit enables or disables chroma (color) on the baseband signal. 0 = disabled, 1 = enabled.

The AuralSub (aural sub-carrier) field selects the source of the FM aural (audio) sub-carrier frequency to be modulated on. The source is the PLLA of one of the cogs, identified by AuralSub's value. This audio must already be modulated onto the 4.5 MHz sub-carrier by the source PLLA.

Table 9: The AuralSub Field	
AuralSub	Sub-Carrier Frequency Source
000	Cog 0's PLLA
001	Cog 1's PLLA
010	Cog 2's PLLA
011	Cog 3's PLLA
100	Cog 4's PLLA
101	Cog 5's PLLA
110	Cog 6's PLLA
111	Cog 7's PLLA

The VGroup (video output pin group) field selects which group of 8 I/O pins to output video on.

Table 10: The VGroup Field	
VGroup	Pin Group
000	Group 0: P7..P0
001	Group 1: P15..P8
010	Group 2: P23..P16
011	Group 3: P31..P24
100-111	<reserved for future use>

The VPins (video output pins) field is a mask applied to the pins of VGroup that indicates which pins to output video signals on.

Table 11: The VPins Field	
VPins	Effect
00001111	Drive Video on lower 4 pins only; composite
11110000	Drive Video on upper 4 pins only; composite
11111111	Drive video on all 8 pins; VGA
xxxxxxx	Any value is valid for this field; the above values are the most common.

#### 4.10.2. VSCL – Video Scale Register

The Video Scale Register sets the rate at which video data is generated, and is shown in Table 12.

Table 12: VSCL Register		
VSCL Bits		
31..20	19..12	11..0
-	PixelClocks	FrameClocks

The 8-bit PixelClocks field indicates the number of clocks per pixel; the number of clocks that should elapse before each pixel is shifted out by the video generator module. These clocks are the PLLA clocks, not the System Clock. A value of 0 for this field is interpreted as 256.

The 12-bit FrameClocks field indicates the number of clocks per frame; the number of clocks that will elapse before each frame is shifted out by the video generator module. These clocks are the PLLA clocks, not the System Clock. A frame is one long of pixel data (delivered via the WAITVID command). Since the pixel data is either 16 bits by 2 bits, or 32 bits by 1 bit (meaning 16 pixels wide with 4 colors, or 32 pixels wide with 2 colors, respectively), the FrameClocks is typically 16 or 32 times that of the PixelClocks value. A value of 0 for this field is interpreted as 4096.

#### 4.10.3. WAITVID Command/Instruction

The WAITVID instruction is the delivery mechanism for data to the cog's Video Generator hardware. Since the Video Generator works independently from the cog itself, the two must synchronize each time data is needed for the display device. The frequency at which this occurs is dictated by the frequency of PLLA and the Video Scale Register. The cog must have new data available before the moment the Video Generator needs it. The cog uses WAITVID to wait for the right time and then "hand off" this data to the Video Generator.

Two longs of data are passed to the Video Generator by with the syntax WAITVID Colors, Pixels.

The Colors parameter is a 32-bit value containing either four 8-bit color values (for 4 color mode) or two 8-bit color values in the lower 16 bits (for 2 color mode). For

VGA mode, each 8-bit color value is written to the pins specified by the VGroup and VPins field. For VGA typically the 8 bits are grouped into 2 bits per primary color and Horizontal and Vertical Sync control lines, but this is up to the software and application of how these bits are used. For composite video each 8-bit color value is composed of 3 fields. Bits 0-2 are the luminance value of the generated signal. Bit 3 is the modulation bit which dictates whether the chroma information will be generated and bits 4-7 indicate the phase angle of the chroma value. When the modulation bit is set to 0, the chroma information is ignored and only the luminance value is output to pins. When the modulation bit is set to 1 the luminance value is modulated  $\pm 1$  with a phase angle set by bits 4-7. In order to achieve the full resolution of the chroma value, PLLA should be set to 16 times the modulation frequency (in composite video this is called the color-burst frequency). The PLLB of the cog is used to generate the broadcast frequency; whether this is generated depends on if PLLB is running and the values of VMode and VPins.

The *Pixels* parameter describes the pixel pattern to display, either 16 pixels or 32 pixels depending on the color depth configuration of the Video Generator. When four-color mode is specified, *Pixels* is a 16x2 bit pattern where each 2-bit pixel is an index into *Colors* on which data pattern should be presented to the pins. When two-color mode is specified, *Pixels* is a 32x1 bit pattern where each bit specifies which of the two color patterns in the lower 16 bits of *Colors* should be output to the pins. The Pixel data is shifted out least significant bits (LSB) first.

When the FrameClocks value is greater than 16 times the PixelClocks value and 4-color mode is specified, the two most significant bits are repeated until FrameClocks PLLA cycles have occurred. When FrameClocks value is greater than 32 times PixelClocks value and 2-color mode is specified, the most significant bit is repeated until FrameClocks PLLA cycles have occurred. When FrameClocks cycles occur and the cog is not in a WAITVID instruction, whatever data is on the source and destination busses at the time will be fetched and used. So it is important to be in a WAITVID instruction before this occurs.

While the Video Generator was created to display video signals, its potential applications are much more diverse. The Composite Video mode can be used to generate phase-shift keying communications of a granularity of 16 or less and the VGA mode can be used to generate any bit pattern with a fully settable and predictable rate.

Figure 6 is a block diagram of how the VGA mode is organized. The two inverted triangles are the load mechanism for *Pixels* and *Colors*; *n* is 1 or 2 bits depending on the value of CMode. The inverted trapezoid is a 4-way 8-bit multiplexer that chooses which byte of *Colors* to output. When in composite video mode the Modulator transforms the byte into the luminance and chroma signal and outputs the broadcast signal. VGroup steers the 8 bits to a block of output pins and outputs to those pins which are set to 1 in VPins; this combined functionality is represented by the hexagon.

Figure 6: Video Generator

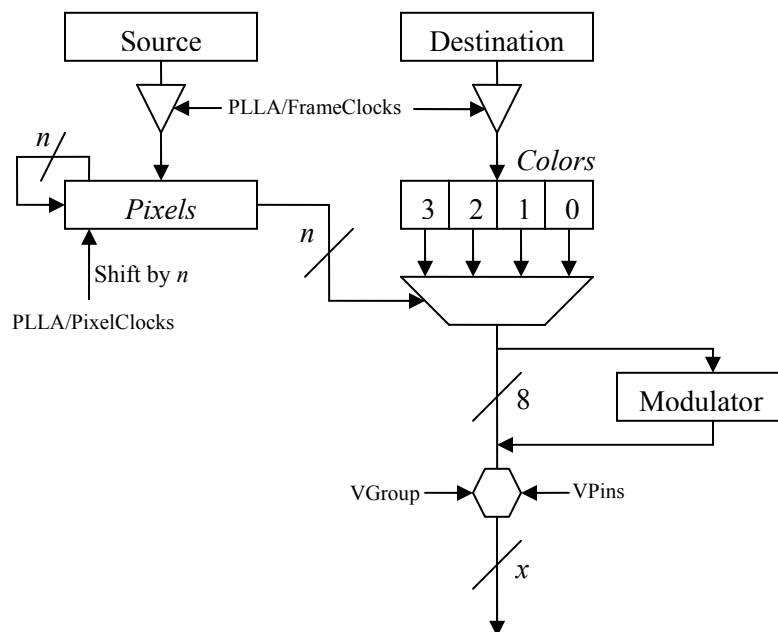

### 4.11. CLK Register

The CLK register is the System Clock configuration control; it determines the source and characteristics of the System Clock. It configures the RC Oscillator, Clock PLL, Crystal Oscillator, and Clock Selector circuits (See the Block Diagram, page 1). It is configured at compile time by the `_CLKMODE` declaration and is writable at run time through the `CLKSET` command. Whenever the CLK register is written, a global delay of ~75 μs occurs as the clock source transitions.

Whenever this register is changed, a copy of the value written should be placed in the Clock Mode value location (which is `BYTE[4]` in Main RAM) and the resulting master clock frequency should be written to the Clock Frequency value location (which is `LONG[0]` in Main RAM) so that objects which reference this data will have current information for their timing calculations.

Use Spin's `CLKSET` command when possible (see sections 6.3 and 6.4) since it automatically updates all the above-mentioned locations with the proper information.

Valid Expression	CLK Reg. Value	Valid Expression	CLK Reg. Value
RCFAST	0_0_0_00_000	XTAL1 + PLL1X	0_1_1_01_011
RCSLOW	0_0_0_00_001	XTAL1 + PLL2X	0_1_1_01_100
		XTAL1 + PLL4X	0_1_1_01_101
XINPUT	0_0_1_00_010	XTAL1 + PLL8X	0_1_1_01_110
		XTAL1 + PLL16X	0_1_1_01_111
XTAL1	0_0_1_01_010	XTAL2 + PLL1X	0_1_1_10_011
		XTAL2 + PLL2X	0_1_1_10_100
XTAL2	0_0_1_10_010	XTAL2 + PLL4X	0_1_1_10_101
		XTAL2 + PLL8X	0_1_1_10_110
XTAL3	0_0_1_11_010	XTAL2 + PLL16X	0_1_1_10_111
		XTAL3 + PLL1X	0_1_1_11_011
XINPUT + PLL1X	0_1_1_00_011	XTAL3 + PLL2X	0_1_1_11_100
XINPUT + PLL2X	0_1_1_00_100	XTAL3 + PLL4X	0_1_1_11_101
XINPUT + PLL4X	0_1_1_00_101	XTAL3 + PLL8X	0_1_1_11_110
XINPUT + PLL8X	0_1_1_00_110	XTAL3 + PLL16X	0_1_1_11_111
XINPUT + PLL16X	0_1_1_00_111		

Bit	7	6	5	4	3	2	1	0
<b>Name</b>	RESET	PLLENA	OSCENA	OSCM1	OSCM2	CLKSEL2	CLKSEL1	CLKSELO
<b>RESET</b>	<b>Effect</b>							
<b>0</b>	Always write '0' here unless you intend to reset the chip.							
<b>1</b>	Same as a hardware reset – reboots the chip.							
<b>PLLENA</b>	<b>Effect</b>							
<b>0</b>	Disables the PLL circuit.							
<b>1</b>	Enables the PLL circuit. The PLL internally multiplies the XIN pin frequency by 16. OSCENA must be '1' to propagate the XIN signal to the PLL. The PLL's internal frequency must be kept within 64 MHz to 128 MHz – this translates to an XIN frequency range of 4 MHz to 8 MHz. Allow 100 μs for the PLL to stabilize before switching to one of its outputs via the CLKSEL bits. Once the OSC and PLL circuits are enabled and stabilized, you can switch freely among all clock sources by changing the CLKSEL bits.							
<b>OSCENA</b>	<b>Effect</b>							
<b>0</b>	Disables the OSC circuit							
<b>1</b>	Enables the OSC circuit so that a clock signal can be input to XIN, or so that XIN and XOUT can function together as a feedback oscillator. The OSCM bits select the operating mode of the OSC circuit. Note that no external resistors or capacitors are required for crystals and resonators. Allow a crystal or resonator 10 ms to stabilize before switching to an OSC or PLL output via the CLKSEL bits. When enabling the OSC circuit, the PLL may be enabled at the same time so that they can share the stabilization period.							
<b>OSCM1</b>	<b>OSCM2</b>	<b>XOUT Resistance</b>		<b>XIN and XOUT Capacitance</b>		<b>Frequency Range</b>		
<b>0</b>	<b>0</b>	Infinite		6 pF (pad only)		DC to 80 MHz Input		
<b>0</b>	<b>1</b>	2000 Ω		36 pF		4 MHz to 16 MHz Crystal/Resonator		
<b>1</b>	<b>0</b>	1000 Ω		26 pF		8 MHz to 32 MHz Crystal/Resonator		
<b>1</b>	<b>1</b>	500 Ω		16 pF		20 MHz to 60 MHz Crystal/Resonator		
<b>CLKSEL2</b>	<b>CLKSEL1</b>	<b>CLKSELO</b>	<b>Master Clock</b>		<b>Source</b>	<b>Notes</b>		
<b>0</b>	<b>0</b>	<b>0</b>	~12 MHz		Internal	No external parts (8 to 20 MHz)		
<b>0</b>	<b>0</b>	<b>1</b>	~20 kHz		Internal	No external parts, very low power (13-33 kHz)		
<b>0</b>	<b>1</b>	<b>0</b>	XIN		OSC	OSCENA must be '1'		
<b>0</b>	<b>1</b>	<b>1</b>	XIN × 1		OSC+PLL	OSCENA and PLLENA must be '1'		
<b>1</b>	<b>0</b>	<b>0</b>	XIN × 2		OSC+PLL	OSCENA and PLLENA must be '1'		
<b>1</b>	<b>0</b>	<b>1</b>	XIN × 4		OSC+PLL	OSCENA and PLLENA must be '1'		
<b>1</b>	<b>1</b>	<b>0</b>	XIN × 8		OSC+PLL	OSCENA and PLLENA must be '1'		
<b>1</b>	<b>1</b>	<b>1</b>	XIN × 16		OSC+PLL	OSCENA and PLLENA must be '1'		

## 5.0 MEMORY ORGANIZATION

### 5.1. Main Memory

The Main Memory is a block of 64 K bytes (16 K longs) that is accessible by all cogs as a mutually-exclusive resource through the Hub. It consists of 32 KB of RAM and 32 KB of ROM. Main memory is byte, word and long addressable. Words and longs are stored in little endian format; least-significant byte first.

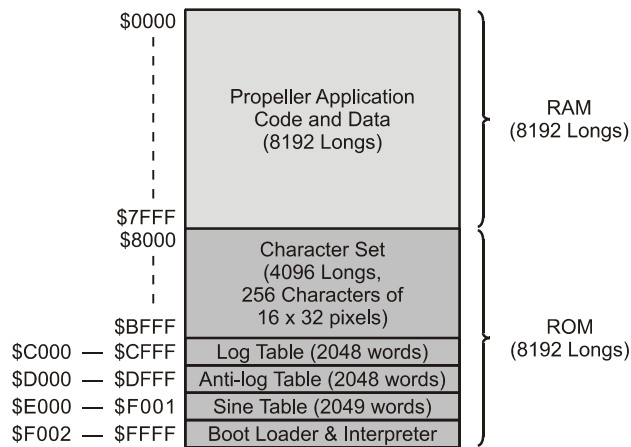

#### 5.1.1. Main RAM

The 32 KB of Main RAM is general purpose and is the destination of a Propeller Application either downloaded from a host or from the external 32 KB EEPROM.

#### 5.1.2. Main ROM

The 32 KB of Main ROM contains all the code and data resources vital to the Propeller chip's function: character definitions, log, anti-log and sine tables, and the Boot Loader and Spin Interpreter.

#### 5.1.3. Character Definitions

The first half of ROM is dedicated to a set of 256 character definitions. Each character definition is 16 pixels wide by 32 pixels tall. These character definitions can be used for video generation, graphical LCD's, printing, etc.

The character set is based on a North American / Western European layout, with many specialized characters added and inserted. There are connecting waveform and schematic building-block characters, Greek characters commonly used in electronics, and several arrows and bullets. (A corresponding Parallax True-Type Font is installed with and used by the Propeller Tool software, and is available to other Windows applications.)

The character definitions are numbered 0 to 255 from left-to-right, then top-to-bottom, per Figure 7 below. They are arranged as follows: Each pair of adjacent even-odd characters is merged together to form 32 longs. The first character pair is located in \$8000-\$807F. The second pair occupies \$8080-\$80FF, and so on, until the last pair fills \$BF80-\$BFFF.

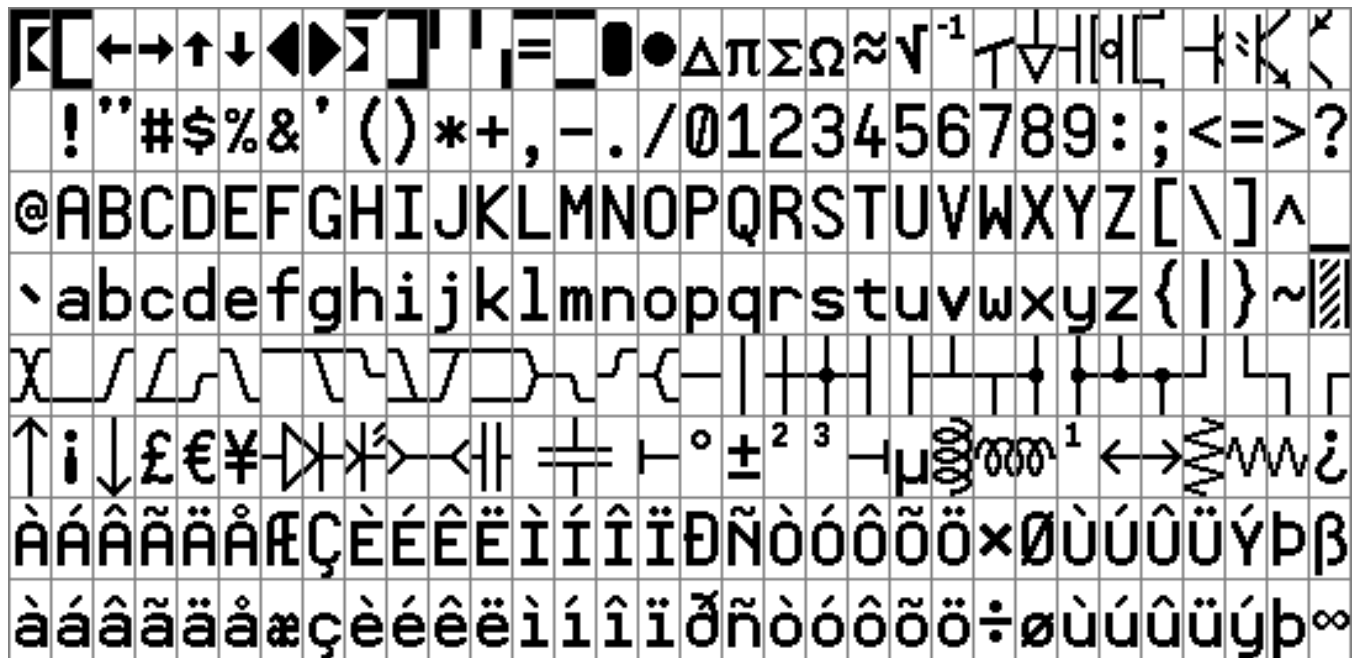

Figure 7: Propeller Font Character Set





## 6.0 PROGRAMMING LANGUAGES

The Propeller chip is programmed using two languages designed specifically for it: 1) Spin, a high-level object-based language, and 2) Propeller Assembly, a low-level, highly-optimized assembly language. There are many hardware-based commands in Propeller Assembly that have direct equivalents in the Spin language.

The Spin language is compiled by the Propeller Tool software into tokens that are interpreted at run time by the Propeller chip's built-in Spin Interpreter. The Propeller Assembly language is assembled into pure machine code by the Propeller Tool and is executed in its pure form at run time.

Propeller Objects can be written entirely in Spin or can use various combinations of Spin and Propeller Assembly. It is often advantageous to write objects almost entirely in Propeller Assembly, but at least two lines of Spin code are required to launch the final application.

### 6.1. Reserved Word List

All words listed are always reserved, whether programming in Spin or in Propeller Assembly. **As of Propeller Tool v1.05:**

Table 16: Reserved Word List						
_CLKFREQ <sup>s</sup>	COGINIT <sup>d</sup>	IF_C_AND_NZ <sup>a</sup>	LOCKNEW <sup>d</sup>	NOP <sup>a</sup>	REPEAT <sup>s</sup>	TRUE <sup>d</sup>
_CLKMODE <sup>s</sup>	COGNEW <sup>s</sup>	IF_C_AND_Z <sup>a</sup>	LOCKRET <sup>d</sup>	NOT <sup>s</sup>	RES <sup>a</sup>	TRUNC <sup>s</sup>
_FREE <sup>s</sup>	COGSTOP <sup>d</sup>	IF_C_EQ_Z <sup>a</sup>	LOCKSET <sup>d</sup>	NR <sup>a</sup>	RESULT <sup>s</sup>	UNTIL <sup>s</sup>
_STACK <sup>s</sup>	CON <sup>s</sup>	IF_C_NE_Z <sup>a</sup>	LONG <sup>s</sup>	OBJ <sup>s</sup>	RET <sup>a</sup>	VAR <sup>s</sup>
_XINFREQ <sup>s</sup>	CONSTANT <sup>s</sup>	IF_C_OR_NZ <sup>a</sup>	LONGFILL <sup>s</sup>	ONES <sup>a#</sup>	RETURN <sup>s</sup>	VCFG <sup>d</sup>
ABORT <sup>s</sup>	CTRA <sup>d</sup>	IF_C_OR_Z <sup>a</sup>	LONGMOVE <sup>s</sup>	OR <sup>d</sup>	REV <sup>a</sup>	VSCL <sup>d</sup>
ABS <sup>a</sup>	CTRB <sup>d</sup>	IF_E <sup>a</sup>	LOOKDOWN <sup>s</sup>	ORG <sup>a</sup>	ROL <sup>a</sup>	WAITCNT <sup>d</sup>
ABSNEG <sup>a</sup>	DAT <sup>s</sup>	IF_NC <sup>a</sup>	LOOKDOWNZ <sup>s</sup>	OTHER <sup>s</sup>	ROR <sup>a</sup>	WAITPEQ <sup>d</sup>
ADD <sup>a</sup>	DIRA <sup>d</sup>	IF_NC_AND_NZ <sup>a</sup>	LOOKUP <sup>s</sup>	OUTA <sup>d</sup>	ROUND <sup>s</sup>	WAITPNE <sup>d</sup>
ADDABS <sup>a</sup>	DIRB <sup>d#</sup>	IF_NC_AND_Z <sup>a</sup>	LOOKUPZ <sup>s</sup>	OUTB <sup>d#</sup>	SAR <sup>a</sup>	WAITVID <sup>d</sup>
ADDS <sup>a</sup>	DJNZ <sup>a</sup>	IF_NC_OR_NZ <sup>a</sup>	MAX <sup>a</sup>	PAR <sup>d</sup>	SHL <sup>a</sup>	WC <sup>a</sup>
ADDSX <sup>a</sup>	ELSE <sup>s</sup>	IF_NC_OR_Z <sup>a</sup>	MAXS <sup>a</sup>	PHSA <sup>d</sup>	SHR <sup>a</sup>	WHILE <sup>s</sup>
ADDX <sup>a</sup>	ELSEIF <sup>s</sup>	IF_NE <sup>a</sup>	MIN <sup>a</sup>	PHSB <sup>d</sup>	SPR <sup>s</sup>	WORD <sup>s</sup>
AND <sup>d</sup>	ELSEIFNOT <sup>s</sup>	IF_NEVER <sup>a</sup>	MINS <sup>a</sup>	PI <sup>d</sup>	STEP <sup>s</sup>	WORDFILL <sup>s</sup>
ANDN <sup>a</sup>	ENC <sup>a#</sup>	IF_NZ <sup>a</sup>	MOV <sup>a</sup>	PLL1X <sup>s</sup>	STRCOMP <sup>s</sup>	WORDMOVE <sup>s</sup>
BYTE <sup>s</sup>	FALSE <sup>d</sup>	IF_NZ_AND_C <sup>a</sup>	MOVD <sup>a</sup>	PLL2X <sup>s</sup>	STRING <sup>s</sup>	WR <sup>a</sup>
BYTEFILL <sup>s</sup>	FILE <sup>s</sup>	IF_NZ_AND_NC <sup>a</sup>	MOVI <sup>a</sup>	PLL4X <sup>s</sup>	STRSIZE <sup>s</sup>	WRBYTE <sup>a</sup>
BYTEMOVE <sup>s</sup>	FIT <sup>a</sup>	IF_NZ_OR_C <sup>a</sup>	MOV <sup>s</sup>	PLL8X <sup>s</sup>	SUB <sup>a</sup>	WRLONG <sup>a</sup>
CALL <sup>a</sup>	FLOAT <sup>s</sup>	IF_NZ_OR_NC <sup>a</sup>	MUL <sup>a#</sup>	PLL16X <sup>s</sup>	SUBABS <sup>a</sup>	WRWORD <sup>a</sup>
CASE <sup>s</sup>	FROM <sup>s</sup>	IF_Z <sup>a</sup>	MULS <sup>a#</sup>	POSX <sup>d</sup>	SUBS <sup>a</sup>	WZ <sup>a</sup>
CHIPVER <sup>s</sup>	FRQA <sup>d</sup>	IF_Z_AND_C <sup>a</sup>	MUXC <sup>a</sup>	PRI <sup>s</sup>	SUBSX <sup>a</sup>	XINPUT <sup>s</sup>
CLKFREQ <sup>s</sup>	FRQB <sup>d</sup>	IF_Z_AND_NC <sup>a</sup>	MUXNC <sup>a</sup>	PUB <sup>s</sup>	SUBX <sup>a</sup>	XOR <sup>a</sup>
CLKMODE <sup>s</sup>	HUBOP <sup>a</sup>	IF_Z_EQ_C <sup>a</sup>	MUXNZ <sup>a</sup>	QUIT <sup>s</sup>	SUMC <sup>a</sup>	XTAL1 <sup>s</sup>
CLKSET <sup>d</sup>	IF <sup>s</sup>	IF_Z_NE_C <sup>a</sup>	MUXZ <sup>a</sup>	RCFAST <sup>s</sup>	SUMNC <sup>a</sup>	XTAL2 <sup>s</sup>
CMP <sup>a</sup>	IFNOT <sup>s</sup>	IF_Z_OR_C <sup>a</sup>	NEG <sup>a</sup>	RCL <sup>a</sup>	SUMNZ <sup>a</sup>	XTAL3 <sup>s</sup>
CMPS <sup>a</sup>	IF_A <sup>a</sup>	IF_Z_OR_NC <sup>a</sup>	NEGC <sup>a</sup>	RCR <sup>a</sup>	SUMZ <sup>a</sup>	
CMPSUB <sup>a</sup>	IF_AE <sup>a</sup>	INA <sup>d</sup>	NEGNC <sup>a</sup>	RCLOW <sup>s</sup>	TEST <sup>a</sup>	
CMPSX <sup>a</sup>	IF_ALWAYS <sup>a</sup>	INB <sup>d#</sup>	NEGNZ <sup>a</sup>	RDBYTE <sup>a</sup>	TESTN <sup>a</sup>	
CMPX <sup>a</sup>	IF_B <sup>a</sup>	JMP <sup>a</sup>	NEGXD <sup>d</sup>	RDLONG <sup>a</sup>	TJNZ <sup>a</sup>	
CNT <sup>d</sup>	IF_BE <sup>a</sup>	JMPRET <sup>a</sup>	NEGZ <sup>a</sup>	RDWORD <sup>a</sup>	TJZ <sup>a</sup>	
COGID <sup>d</sup>	IF_C <sup>a</sup>	LOCKCLR <sup>d</sup>	NEXT <sup>s</sup>	REBOOT <sup>s</sup>	TO <sup>s</sup>	

**a = Assembly element; s = Spin element; d = dual (available in both languages); # = reserved for future use**

#### 6.1.1. Words Reserved for Future Use

- **DIRB, INB, and OUTB:** Reserved for future use with a possible 64 I/O pin model. When used with the P8X32A, these labels can be used to access Cog RAM at those locations for general-purpose use.
- **ENC, MUL, MULS, ONES:** Use with the current P8X32A architecture yields indeterminate results.

## 6.2. Math and Logic Operators

Table 17: Math and Logic Operators

Level <sup>1</sup>	Operator		Constant Expressions <sup>3</sup>		Is Unary	Description
	Normal	Assign <sup>2</sup>	Integer	Float		
Highest (0)	--	always			✓	Pre-decrement (--X) or post-decrement (X--).
	++	always			✓	Pre-increment (++X) or post-increment (X++).
	~	always			✓	Sign-extend bit 7 (~X) or post-clear to 0 (X~).
	~~	always			✓	Sign-extend bit 15 (~~X) or post-set to -1 (X~~).
	?	always			✓	Random number forward (?X) or reverse (X?).
	e	never	✓		✓	Symbol address.
	ee	never			✓	Object address plus symbol.
1	+	never	✓	✓	✓	Positive (+X); unary form of Add.
	-	if solo	✓	✓	✓	Negate (-X); unary form of Subtract.
	^^	if solo	✓	✓	✓	Square root.
		if solo	✓	✓	✓	Absolute value.
	<	if solo	✓		✓	Bitwise: Decode 0 – 31 to long w/single-high-bit.
	>	if solo	✓		✓	Bitwise: Encode long to 0 – 32; high-bit priority.
	!	if solo	✓		✓	Bitwise: NOT.
2	<-	<-=	✓			Bitwise: Rotate left.
	->	->=	✓			Bitwise: Rotate right.
	<<	<<=	✓			Bitwise: Shift left.
	>>	>>=	✓			Bitwise: Shift right.
	~>	~>=	✓			Shift arithmetic right.
	><	><=	✓			Bitwise: Reverse.
3	&	&=	✓			Bitwise: AND.
4		=	✓			Bitwise: OR.
	^	^=	✓			Bitwise: XOR.
5	*	*=	✓	✓		Multiply and return lower 32 bits (signed).
	**	**=	✓			Multiply and return upper 32 bits (signed).
	/	/=	✓	✓		Divide (signed).
	//	//=	✓			Modulus (signed).
6	+	+=	✓	✓		Add.
	-	-=	✓	✓		Subtract.
7	#>	#>=	✓	✓		Limit minimum (signed).
	<#	<#=	✓	✓		Limit maximum (signed).
8	<	<=	✓	✓		Boolean: Is less than (signed).
	>	>=	✓	✓		Boolean: Is greater than (signed).
	<>	<>=	✓	✓		Boolean: Is not equal.
	==	===	✓	✓		Boolean: Is equal.
	=<	=<=	✓	✓		Boolean: Is equal or less (signed).
	=>	=>=	✓	✓		Boolean: Is equal or greater (signed).
9	NOT	if solo	✓	✓	✓	Boolean: NOT (promotes non-0 to -1).
10	AND	AND=	✓	✓		Boolean: AND (promotes non-0 to -1).
11	OR	OR=	✓	✓		Boolean: OR (promotes non-0 to -1).
Lowest (12)	=	always	n/a <sup>3</sup>	n/a <sup>3</sup>		Constant assignment (CON blocks).
	:=	always	n/a <sup>3</sup>	n/a <sup>3</sup>		Variable assignment (PUB/PRI blocks).

<sup>1</sup> Precedence level: higher-level operators evaluate before lower-level operators. Operators in same level are commutable; evaluation order does not matter.

<sup>2</sup> Assignment forms of binary (non-unary) operators are in the lowest precedence (level 12).

<sup>3</sup> Assignment forms of operators are not allowed in constant expressions.

### 6.3. Spin Language Summary Table

Spin Command	Returns Value	Description
ABORT <i>&lt;Value&gt;</i>	✓	Exit from PUB/PRI method using abort status with optional return value.
BYTE <i>Symbol</i> <i>&lt;[Count]&gt;</i>		Declare byte-sized symbol in VAR block.
<i>&lt;Symbol&gt;</i> BYTE <i>Data</i> <i>&lt;[Count]&gt;</i>		Declare byte-aligned and/or byte-sized data in DAT block.
BYTE [ <i>BaseAddress</i> ] <i>&lt;[Offset]&gt;</i>	✓	Read/write byte of main memory.
<i>Symbol</i> .BYTE <i>&lt;[Offset]&gt;</i>	✓	Read/write byte-sized component of word/long-sized variable.
BYTEFILL ( <i>StartAddress</i> , <i>Value</i> , <i>Count</i> )		Fill bytes of main memory with a value.
BYTEMOVE ( <i>DestAddress</i> , <i>SrcAddress</i> , <i>Count</i> )		Copy bytes from one region to another in main memory.
CASE <i>CaseExpression</i> → <i> MatchExpression</i> : → <i> Statement(s)</i> <→ <i> MatchExpression</i> : → <i> Statement(s)</i> <→ <i> OTHER</i> : → <i> Statement(s)</i>		Compare expression against matching expression(s), execute code block if match found.  <i>MatchExpression</i> can contain a single expression or multiple comma-delimited expressions. Expressions can be a single value (ex: 10) or a range of values (ex: 10..15).
CHIPVER	✓	Version number of the Propeller chip (Byte at \$FFFF)
CLKFREQ	✓	Current System Clock frequency, in Hz (Long at \$0000)
CLKMODE	✓	Current clock mode setting (Byte at \$0004)
CLKSET ( <i>Mode</i> , <i>Frequency</i> )		Set both clock mode and System Clock frequency at run time.
CNT	✓	Current 32-bit System Counter value.
COGID	✓	Current cog's ID number; 0-7.
COGINIT ( <i>CogID</i> , <i>SpinMethod</i> <i>&lt;(ParameterList)&gt;</i> , <i>StackPointer</i> )		Start or restart cog by ID to run Spin code.
COGINIT ( <i>CogID</i> , <i>AsmAddress</i> , <i>Parameter</i> )		Start or restart cog by ID to run Propeller Assembly code.
COGNEW ( <i>SpinMethod</i> <i>&lt;(ParameterList)&gt;</i> , <i>StackPointer</i> )	✓	Start new cog for Spin code and get cog ID; 0-7 = succeeded, -1 = failed.
COGNEW ( <i>AsmAddress</i> , <i>Parameter</i> )	✓	Start new cog for Propeller Assembly code and get cog ID; 0-7 = succeeded, -1 = failed.
COGSTOP ( <i>CogID</i> )		Stop cog by its ID.
CON <i>Symbol</i> = <i>Expr</i> <i>&lt;((,   ↲)) Symbol = Expr&gt;...</i>		Declare symbolic, global constants.
CON # <i>Expr</i> <i>&lt;((,   ↲)) Symbol &lt;[Offset]&gt; &lt;((,   ↲)) Symbol &lt;[Offset]&gt; ...</i>		Declare global enumerations (incrementing symbolic constants).
CON <i>Symbol &lt;[Offset]&gt; &lt;((,   ↲)) Symbol &lt;[Offset]&gt; ...</i>		Declare global enumerations (incrementing symbolic constants).
CONSTANT ( <i>ConstantExpression</i> )	✓	Declare in-line constant expression to be completely resolved at compile time.
CTRA	✓	Counter A Control register.
CTRB	✓	Counter B Control register.
DAT <i>&lt;Symbol&gt;</i> <i>Alignment</i> <i>&lt;Size&gt;</i> <i>&lt;Data&gt;</i> <i>&lt;[Count]&gt;</i> <i>&lt;, &lt;Size&gt; Data &lt;[Count]&gt;&gt;...</i>		Declare table of data, aligned and sized as specified.
DAT <i>&lt;Symbol&gt;</i> <i>&lt;Condition&gt;</i> <i>Instruction</i> <i>&lt;Effect(s)&gt;</i>		Denote Propeller Assembly instruction.
DIRA <i>&lt;[Pin(s)]&gt;</i>	✓	Direction register for 32-bit port A. Default is 0 (input) upon cog startup.
FILE " <i>FileName</i> "		Import external file as data in DAT block.
FLOAT ( <i>IntegerConstant</i> )	✓	Convert integer constant expression to compile-time floating-point value in any block.
FRQA	✓	Counter A Frequency register.
FRQB	✓	Counter B Frequency register.

Spin Command	Returns Value	Description
<b>((IF   IFNOT))</b> <i>Condition(s)</i> → <i>IfStatement(s)</i> <b>&lt;ELSEIF</b> <i>Condition(s)</i> → <i>ElseIfStatement(s)</i> ... <b>&lt;ELSEIFNOT</b> <i>Condition(s)</i> → <i>ElseIfStatement(s)</i> ... <b>&lt;ELSE</b> → <i>ElseStatement(s)</i>		Test condition(s) and execute block of code if valid.  <b>IF</b> and <b>ELSEIF</b> each test for <b>TRUE</b> . <b>IFNOT</b> and <b>ELSEIFNOT</b> each test for <b>FALSE</b> .
<b>INA</b> <i>&lt;[Pin(s)]&gt;</i>	✓	Input register for 32-bit ports A.
<b>LOCKCLR</b> <i>(ID)</i>	✓	Clear semaphore to false and get its previous state; <b>TRUE</b> or <b>FALSE</b> .
<b>LOCKNEW</b>	✓	Check out new semaphore and get its ID; 0-7, or -1 if none were available.
<b>LOCKRET</b> <i>(ID)</i>		Return semaphore back to semaphore pool, releasing it for future <b>LOCKNEW</b> requests.
<b>LOCKSET</b> <i>(ID)</i>	✓	Set semaphore to true and get its previous state; <b>TRUE</b> or <b>FALSE</b> .
<b>LONG</b> <i>Symbol &lt;[Count]&gt;</i>		Declare long-sized symbol in <b>VAR</b> block.
<i>&lt;Symbol&gt;</i> <b>LONG</b> <i>Data &lt;[Count]&gt;</i>		Declare long-aligned and/or long-sized data in <b>DAT</b> block.
<b>LONG</b> <i>[BaseAddress] &lt;[Offset]&gt;</i>	✓	Read/write long of main memory.
<b>LONGFILL</b> <i>(StartAddress, Value, Count)</i>		Fill longs of main memory with a value.
<b>LONGMOVE</b> <i>(DestAddress, SrcAddress, Count)</i>		Copy longs from one region to another in main memory.
<b>LOOKDOWN</b> <i>(Value: ExpressionList)</i>	✓	Get the one-based index of a value in a list.
<b>LOOKDOWNZ</b> <i>(Value: ExpressionList)</i>	✓	Get the zero-based index of a value in a list.
<b>LOOKUP</b> <i>(Index: ExpressionList)</i>	✓	Get value from a one-based index position of a list.
<b>LOOKUPZ</b> <i>(Index: ExpressionList)</i>	✓	Get value from a zero-based index position of a list.
<b>NEXT</b>		Skip remaining statements of <b>REPEAT</b> loop and continue with the next loop iteration.
<b>OBJ</b> <i>Symbol &lt;[Count]&gt;:"Object" &lt;↳ Symbol &lt;[Count]&gt;:"Object"&gt;...</i>		Declare symbol object references.
<b>OUTA</b> <i>&lt;[Pin(s)]&gt;</i>	✓	Output register for 32-bit port A. Default is 0 (ground) upon cog startup.
<b>PAR</b>	✓	Cog Boot Parameter register.
<b>PHSA</b>	✓	Counter A Phase Lock Loop (PLL) register.
<b>PHSB</b>	✓	Counter B Phase Lock Loop (PLL) register.
<b>PRI</b> <i>Name &lt;{Par &lt;,&gt;Par}&gt; &lt;:RVal&gt; &lt;  LVar &lt;[Cnt]&gt;&gt; &lt;,LVar &lt;[Cnt]&gt;&gt;...</i> <i>SourceCodeStatements</i>		Declare private method with optional parameters, return value and local variables.
<b>PUB</b> <i>Name &lt;{Par &lt;,&gt;Par}&gt; &lt;:RVal&gt; &lt;  LVar &lt;[Cnt]&gt;&gt; &lt;,LVar &lt;[Cnt]&gt;&gt;...</i> <i>SourceCodeStatements</i>		Declare public method with optional parameters, return value and local variables.
<b>QUIT</b>		Exit from <b>REPEAT</b> loop immediately.
<b>REBOOT</b>		Reset the Propeller chip.
<b>REPEAT</b> <i>&lt;Count&gt;</i> → <i>Statement(s)</i>		Execute code block repetitively, either infinitely, or for a finite number of iterations.
<b>REPEAT</b> <i>Variable FROM Start TO Finish &lt;STEP Delta&gt;</i> → <i>Statement(s)</i>		Execute code block repetitively, for finite, counted iterations.
<b>REPEAT</b> <b>((UNTIL   WHILE))</b> <i>Condition(s)</i> → <i>Statement(s)</i>		Execute code block repetitively, zero-to-many conditional iterations.
<b>REPEAT</b> → <i>Statement(s)</i> <b>((UNTIL   WHILE))</b> <i>Condition(s)</i>		Execute code block repetitively, one-to-many conditional iterations.
<b>RESULT</b>	✓	Return value variable for <b>PUB/PRI</b> methods.
<b>RETURN</b> <i>&lt;Value&gt;</i>	✓	Exit from <b>PUB/PRI</b> method with optional return <i>Value</i> .
<b>ROUND</b> <i>(FloatConstant)</i>	✓	Round floating-point constant to the nearest integer at compile-time, in any block.
<b>SPR</b> <i>[Index]</i>	✓	Special Purpose Register array.
<b>STRCOMP</b> <i>(StringAddress1, StringAddress2)</i>	✓	Compare two strings for equality.
<b>STRING</b> <i>(StringExpression)</i>	✓	Declare in-line string constant and get its address.

Spin Command	Returns Value	Description
STRSIZE ( <i>StringAddress</i> )	✓	Get size, in bytes, of zero-terminate string.
TRUNC ( <i>FloatConstant</i> )	✓	Remove fractional portion from floating-point constant at compile-time, in any block.
VAR Size Symbol <[Count]> <((,   ↳ Size)) Symbol <[Count]>>...		Declare symbolic global variables.
VCFG	✓	Video Configuration register.
VSCL	✓	Video Scale register.
WAITCNT ( <i>Value</i> )		Pause cog's execution temporarily.
WAITPEQ ( <i>State, Mask, Port</i> )		Pause cog's execution until I/O pin(s) match designated state(s).
WAITPNE ( <i>State, Mask, Port</i> )		Pause cog's execution until I/O pin(s) do not match designated state(s).
WAITVID ( <i>Colors, Pixels</i> )		Pause cog's execution until its Video Generator is available for pixel data.
WORD Symbol <[Count]>		Declare word-sized symbol in VAR block.
<Symbol> WORD Data <[Count]>		Declare word-aligned and/or word-sized data in DAT block.
WORD [ <i>BaseAddress</i> ] <[Offset]>	✓	Read/write word of main memory.
Symbol.WORD <[Offset]>	✓	Read/write word-sized component of long-sized variable.
WORDFILL ( <i>StartAddress, Value, Count</i> )		Fill words of main memory with a value.
WORDMOVE ( <i>DestAddress, SrcAddress, Count</i> )		Copy words from one region to another in main memory.

### 6.3.1. Constants

Constants (pre-defined)			
Constant <sup>1</sup>	Description		
_CLKFREQ	Settable in Top Object File to specify System Clock frequency.		
_CLKMODE	Settable in Top Object File to specify application's clock mode.		
_XINFREQ	Settable in Top Object File to specify external crystal frequency.		
_FREE	Settable in Top Object File to specify application's free space.		
_STACK	Settable in Top Object File to specify application's stack space.		
TRUE	Logical true:	-1	(\$FFFFFFF)
FALSE	Logical false:	0	(\$0000000)
POSX	Max. positive integer:	2,147,483,647	(\$7FFFFFFF)
NEGX	Max. negative integer:	-2,147,483,648	(\$80000000)
PI	Floating-point PI:	≈ 3.141593	(\$40490FDB)
RCFAST	Internal fast oscillator:	\$00000001	(%000000000001)
RCSLOW	Internal slow oscillator:	\$00000002	(%000000000010)
XINPUT	External clock/oscillator:	\$00000004	(%00000000100)
XTAL1	External low-speed crystal:	\$00000008	(%00000001000)
XTAL2	External medium-speed crystal:	\$00000010	(%00000010000)
XTAL3	External high-speed crystal:	\$00000020	(%00000100000)
PLL1X	External frequency times 1:	\$00000040	(%00001000000)
PLL2X	External frequency times 2:	\$00000080	(%00010000000)
PLL4X	External frequency times 4:	\$00000100	(%00100000000)
PLL8X	External frequency times 8:	\$00000200	(%01000000000)
PLL16X	External frequency times 16:	\$00000400	(%10000000000)

<sup>1</sup> "Settable" constants are defined in Top Object File's CON block. See Valid Clock Modes for \_CLKMODE. Other settable constants use whole numbers.

### 6.4. Propeller Assembly Instruction Table

The Propeller Assembly Instruction Table lists the instruction’s 32-bit opcode, outputs and number of clock cycles. The opcode consists of the instruction bits (iiiiii), the “effect” status for the Z flag, C flag, result and indirect/immediate status (zcri), the conditional execution bits (cccc), and the destination and source bits (dddddddd and ssssssss). The meaning of the Z and C flags, if any, is shown in the **Z Result** and **C Result** fields; indicating the meaning of a 1 in those flags. The Result field (**R**) shows the instruction’s default behavior for writing (1) or not writing (0) the instruction’s result value. The **Clocks** field shows the number of clocks the instruction requires for execution.

- 0 1      Zeros (0) and ones (1) mean binary 0 and 1.
- i        Lower case “i” denotes a bit that is affected by immediate status.
- d s      Lower case “d” and “s” indicate destination and source bits.
- ?        Question marks denote bits that are dynamically set by the compiler.
- Hyphens indicate items that are not applicable or not important.
- ..       Double-periods represent a range of contiguous values.

iiiiii	zcri	cccc	dddddddd	sssssss	Instruction	Description	Z Result	C Result	R	Clocks
000000	000i	1111	dddddddd	sssssss	WRBYTE D, S	Write D[7..0] to main memory byte S[15..0]	-	-	0	8.23 *
000000	001i	1111	dddddddd	sssssss	RDBYTE D, S	Read main memory byte S[15..0] into D (0-extended)	Result = 0	-	1	8.23 *
000001	000i	1111	dddddddd	sssssss	WRWORD D, S	Write D[15..0] to main memory word S[15..1]	-	-	0	8.23 *
000001	001i	1111	dddddddd	sssssss	RDWORD D, S	Read main memory word S[15..1] into D (0-extended)	Result = 0	-	1	8.23 *
000010	000i	1111	dddddddd	sssssss	WRLONG D, S	Write D to main memory long S[15..2]	-	-	0	8.23 *
000010	001i	1111	dddddddd	sssssss	RDLONG D, S	Read main memory long S[15..2] into D	Result = 0	-	1	8.23 *
000011	000i	1111	dddddddd	sssssss	HUBOP D, S	Perform hub operation according to S	Result = 0	-	0	8.23 *
000011	0001	1111	dddddddd	-----000	CLKSET D	Set the global CLK register to D[7..0]	-	-	0	8.23 *
000011	0011	1111	dddddddd	-----001	COGID D	Get this cog number (0..7) into D	ID = 0	0	1	8.23 *
000011	0001	1111	dddddddd	-----010	COGINIT D	Initialize a cog according to D	ID = 0	No cog free	0	8.23 *
000011	0001	1111	dddddddd	-----011	COGSTOP D	Stop cog number D[2..0]	Stopped ID = 0	No Cog Free	0	8.23 *
000011	0011	1111	dddddddd	-----100	LOCKNEW D	Checkout a new LOCK number (0..7) into D	ID = 0	No lock free	1	8.23 *
000011	0001	1111	dddddddd	-----101	LOCKRET D	Return lock number D[2..0]	ID = 0	No lock free	0	8.23 *
000011	0001	1111	dddddddd	-----110	LOCKSET D	Set lock number D[2..0]	ID = 0	Prior lock state	0	8.23 *
000011	0001	1111	dddddddd	-----111	LOCKCLR D	Clear lock number D[2..0]	ID = 0	Prior lock state	0	8.23 *
000100	001i	1111	dddddddd	sssssss	MUL D, S	Multiply unsigned D[15..0] by S[15..0]	Result = 0	-	1	future
000101	001i	1111	dddddddd	sssssss	MULS D, S	Multiply signed D[15..0] by S[15..0]	Result = 0	-	1	future
000110	001i	1111	dddddddd	sssssss	ENC D, S	Encode magnitude of S into D, result = 0..31	Result = 0	-	1	future
000111	001i	1111	dddddddd	sssssss	ONES D, S	Get number of 1's in S into D, result = 0..31	Result = 0	-	1	future
001000	001i	1111	dddddddd	sssssss	ROR D, S	Rotate D right by S[4..0] bits	Result = 0	D[0]	1	4
001001	001i	1111	dddddddd	sssssss	ROL D, S	Rotate D left by S[4..0] bits	Result = 0	D[31]	1	4
001010	001i	1111	dddddddd	sssssss	SHR D, S	Shift D right by S[4..0] bits, set new MSB to 0	Result = 0	D[0]	1	4
001011	001i	1111	dddddddd	sssssss	SHL D, S	Shift D left by S[4..0] bits, set new LSB to 0	Result = 0	D[31]	1	4
001100	001i	1111	dddddddd	sssssss	RCR D, S	Rotate carry right into D by S[4..0] bits	Result = 0	D[0]	1	4
001101	001i	1111	dddddddd	sssssss	RCL D, S	Rotate carry left into D by S[4..0] bits	Result = 0	D[31]	1	4
001110	001i	1111	dddddddd	sssssss	SAR D, S	Shift D arithmetically right by S[4..0] bits	Result = 0	D[0]	1	4
001111	001i	1111	dddddddd	sssssss	REV D, S	Reverse 32-S[4..0] bottom bits in D and 0-extend	Result = 0	D[0]	1	4
010000	001i	1111	dddddddd	sssssss	MINS D, S	Set D to S if signed (D < S)	S = 0	Signed (D < S)	1	4
010001	001i	1111	dddddddd	sssssss	MAXS D, S	Set D to S if signed (D => S)	S = 0	Signed (D < S)	1	4
010010	001i	1111	dddddddd	sssssss	MIN D, S	Set D to S if unsigned (D < S)	S = 0	Unsigned (D < S)	1	4
010011	001i	1111	dddddddd	sssssss	MAX D, S	Set D to S if unsigned (D => S)	S = 0	Unsigned (D < S)	1	4
010100	001i	1111	dddddddd	sssssss	MOV8 D, S	Insert S[8..0] into D[8..0]	Result = 0	-	1	4
010101	001i	1111	dddddddd	sssssss	MOV9 D, S	Insert S[8..0] into D[17..9]	Result = 0	-	1	4
010110	001i	1111	dddddddd	sssssss	MOV23 D, S	Insert S[8..0] into D[31..23]	Result = 0	-	1	4
010111	001i	1111	dddddddd	sssssss	JMPRET D, S	Insert PC+1 into D[8..0] and set PC to S[8..0]	Result = 0	-	1	4
010111	000i	1111	-----	sssssss	JMP S	Set PC to S[8..0]	Result = 0	-	0	4

iiii zcri cccc dddddddd ssssssss	Instruction	Description	Z Result	C Result	R	Clocks
010111 001i 1111 ?????????? ssssssss	CALL #S	Like JMPRET, but assembler handles details	Result = 0	-	1	4
010111 0001 1111 -----	RET	Like JMP, but assembler handles details	Result = 0	-	0	4
011000 000i 1111 dddddddd ssssssss	TEST D, S	AND S with D to affect flags only	D = 0	Parity of Result	0	4
011001 000i 1111 dddddddd ssssssss	TESTN D, S	AND !S into D to affect flags only	Result = 0	Parity of Result	0	4
011000 001i 1111 dddddddd ssssssss	AND D, S	AND S into D	Result = 0	Parity of Result	1	4
011001 001i 1111 dddddddd ssssssss	ANDN D, S	AND !S into D	Result = 0	Parity of Result	1	4
011010 001i 1111 dddddddd ssssssss	OR D, S	OR S into D	Result = 0	Parity of Result	1	4
011011 001i 1111 dddddddd ssssssss	XOR D, S	XOR S into D	Result = 0	Parity of Result	1	4
011100 001i 1111 dddddddd ssssssss	MUXC D, S	Copy C to bits in D using S as mask	Result = 0	Parity of Result	1	4
011101 001i 1111 dddddddd ssssssss	MUXNC D, S	Copy !C to bits in D using S as mask	Result = 0	Parity of Result	1	4
011110 001i 1111 dddddddd ssssssss	MUXZ D, S	Copy Z to bits in D using S as mask	Result = 0	Parity of Result	1	4
011111 001i 1111 dddddddd ssssssss	MUXNZ D, S	Copy !Z to bits in D using S as mask	Result = 0	Parity of Result	1	4
100000 001i 1111 dddddddd ssssssss	ADD D, S	Add S into D	D + S = 0	Unsigned Carry	1	4
100001 001i 1111 dddddddd ssssssss	SUB D, S	Subtract S from D	D - S = 0	Unsigned Borrow	1	4
100001 000i 1111 dddddddd ssssssss	CMP D, S	Compare D to S	D = S	Unsigned (D < S)	0	4
100010 001i 1111 dddddddd ssssssss	ADDABS D, S	Add absolute S into D	D +  S  = 0	Unsigned Carry <sup>1</sup>	1	4
100011 001i 1111 dddddddd ssssssss	SUBABS D, S	Subtract absolute S from D	D -  S  = 0	Unsigned Borrow <sup>2</sup>	1	4
100100 001i 1111 dddddddd ssssssss	SUMC D, S	Sum either -S if C or S if !C into D	D ± S = 0	Signed Overflow	1	4
100101 001i 1111 dddddddd ssssssss	SUMNC D, S	Sum either S if C or -S if !C into D	D ± S = 0	Signed Overflow	1	4
100110 001i 1111 dddddddd ssssssss	SUMZ D, S	Sum either -S if Z or S if !Z into D	D ± S = 0	Signed Overflow	1	4
100111 001i 1111 dddddddd ssssssss	SUMNZ D, S	Sum either S if Z or -S if !Z into D	D ± S = 0	Signed Overflow	1	4
101000 001i 1111 dddddddd ssssssss	MOV D, S	Set D to S	Result = 0	S[31]	1	4
101001 001i 1111 dddddddd ssssssss	NEG D, S	Set D to -S	Result = 0	S[31]	1	4
101010 001i 1111 dddddddd ssssssss	ABS D, S	Set D to absolute S	Result = 0	S[31]	1	4
101011 001i 1111 dddddddd ssssssss	ABSNEG D, S	Set D to -absolute S	Result = 0	S[31]	1	4
101100 001i 1111 dddddddd ssssssss	NEGC D, S	Set D to either -S if C or S if !C	Result = 0	S[31]	1	4
101101 001i 1111 dddddddd ssssssss	NEGNC D, S	Set D to either S if C or -S if !C	Result = 0	S[31]	1	4
101110 001i 1111 dddddddd ssssssss	NEGZ D, S	Set D to either -S if Z or S if !Z	Result = 0	S[31]	1	4
101111 001i 1111 dddddddd ssssssss	NEGNZ D, S	Set D to either S if Z or -S if !Z	Result = 0	S[31]	1	4
110000 000i 1111 dddddddd ssssssss	CMPS D, S	Compare-signed D to S	D = S	Signed (D < S)	0	4
110001 000i 1111 dddddddd ssssssss	CMPSX D, S	Compare-signed-extended D to S+C	Z & (D = S+C)	Signed (D < S+C)	0	4
110010 001i 1111 dddddddd ssssssss	ADDX D, S	Add-extended S+C into D	Z & (D+S+C = 0)	Unsigned Carry	1	4
110011 001i 1111 dddddddd ssssssss	SUBX D, S	Subtract-extended S+C from D	Z & (D-(S+C)=0)	Unsigned Borrow	1	4
110011 000i 1111 dddddddd ssssssss	CMPX D, S	Compare-extended D to S+C	Z & (D = S+C)	Signed (D < S+C)	0	4
110100 001i 1111 dddddddd ssssssss	ADDS D, S	Add-signed S into D	D + S = 0	Signed Overflow	1	4
110101 001i 1111 dddddddd ssssssss	SUBS D, S	Subtract-signed S from D	D - S = 0	Signed Overflow	1	4
110110 001i 1111 dddddddd ssssssss	ADDSX D, S	Add-signed-extended S+C into D	Z & (D+S+C = 0)	Signed Overflow	1	4
110111 001i 1111 dddddddd ssssssss	SUBSX D, S	Subtract-signed-extended S+C from D	Z & (D-(S+C)=0)	Signed Overflow	1	4
111000 001i 1111 dddddddd ssssssss	CMPSUB D, S	Subtract S from D if D => S	D = S	Unsigned (D => S)	1	4
111001 001i 1111 dddddddd ssssssss	DJNZ D, S	Dec D, jump if not zero to S (no jump = 8 clocks)	Result = 0	Unsigned Borrow	1	4 or 8
111010 000i 1111 dddddddd ssssssss	TJNZ D, S	Test D, jump if not zero to S (no jump = 8 clocks)	D = 0	0	0	4 or 8
111011 000i 1111 dddddddd ssssssss	TJZ D, S	Test D, jump if zero to S (no jump = 8 clocks)	D = 0	0	0	4 or 8
111100 000i 1111 dddddddd ssssssss	WAITPEQ D, S	Wait for pins equal - (INA & S) = D	-	-	0	6+
111101 000i 1111 dddddddd ssssssss	WAITPNE D, S	Wait for pins not equal - (INA & S) != D	-	-	0	6+
111110 001i 1111 dddddddd ssssssss	WAITCNT D, S	Wait for CNT = D, then add S into D	-	Unsigned Carry	1	6+
111111 000i 1111 dddddddd ssssssss	WAITVID D, S	Wait for video peripheral to grab D and S	-	-	0	4+ <sup>3</sup>
----- 0000 -----	NOP	No operation, just elapses 4 clocks	-	-	-	4

\* See Hub, section 4.4 on page 7.

1. ADDABS C out: If S is negative, C = the inverse of unsigned borrow (for D-S).
2. SUBABS C out: If S is negative, C = the inverse of unsigned carry (for D+S).
3. WAITVID consumes 4 clocks itself; however, complete data handoff requires 7 clocks (6 at some frequencies) between frames. The combination of CTRA PLL frequency and VSCL FrameClocks must provide an effective 7 (or 6) system clocks.

### 6.4.1. Assembly Conditions

Condition	Instruction Executes
IF_ALWAYS	always
IF_NEVER	never
IF_E	if equal (Z)
IF_NE	if not equal (!Z)
IF_A	if above (!C & !Z)
IF_B	if below (C)
IF_AE	if above/equal (!C)
IF_BE	if below/equal (C   Z)
IF_C	if C set
IF_NC	if C clear
IF_Z	if Z set
IF_NZ	if Z clear
IF_C_EQ_Z	if C equal to Z
IF_C_NE_Z	if C not equal to Z
IF_C_AND_Z	if C set and Z set
IF_C_AND_NZ	if C set and Z clear
IF_NC_AND_Z	if C clear and Z set
IF_NC_AND_NZ	if C clear and Z clear
IF_C_OR_Z	if C set or Z set
IF_C_OR_NZ	if C set or Z clear
IF_NC_OR_Z	if C clear or Z set
IF_NC_OR_NZ	if C clear or Z clear
IF_Z_EQ_C	if Z equal to C
IF_Z_NE_C	if Z not equal to C
IF_Z_AND_C	if Z set and C set
IF_Z_AND_NC	if Z set and C clear
IF_NZ_AND_C	if Z clear and C set
IF_NZ_AND_NC	if Z clear and C clear
IF_Z_OR_C	if Z set or C set
IF_Z_OR_NC	if Z set or C clear
IF_NZ_OR_C	if Z clear or C set
IF_NZ_OR_NC	if Z clear or C clear

### 6.4.2. Assembly Directives

Directive	Description
FIT <Address>	Validate previous instr/data fit below an address.
ORG <Address>	Adjust compile-time cog address pointer.
<Symbol> RES <Count>	Reserve next long(s) for symbol.

### 6.4.3. Assembly Effects

Effect	Results In
WC	C Flag modified
WZ	Z Flag modified
WR	Destination Register modified
NR	Destination Register not modified

### 6.4.4. Assembly Operators

Propeller Assembly code can contain constant expressions, which may use any operators that are allowed in constant expressions. The table (a subset of Table 17) lists the operators allowed in Propeller Assembly.

Operator	Description
+	Add
+	Positive (+X); unary form of Add
-	Subtract
-	Negate (-X); unary form of Subtract
*	Multiply and return lower 32 bits (signed)
**	Multiply and return upper 32 bits (signed)
/	Divide (signed)
//	Modulus (signed)
#>	Limit minimum (signed)
<#	Limit maximum (signed)
^^	Square root; unary
	Absolute value; unary
~>	Shift arithmetic right
<	Bitwise: Decode value (0-31) into single-high-bit long; unary
>	Bitwise: Encode long into value (0 - 32) as high-bit priority; unary
<<	Bitwise: Shift left
>>	Bitwise: Shift right
<-	Bitwise: Rotate left
->	Bitwise: Rotate right
><	Bitwise: Reverse
&	Bitwise: AND
	Bitwise: OR
^	Bitwise: XOR
!	Bitwise: NOT; unary
AND	Boolean: AND (promotes non-0 to -1)
OR	Boolean: OR (promotes non-0 to -1)
NOT	Boolean: NOT (promotes non-0 to -1); unary
==	Boolean: Is equal
<>	Boolean: Is not equal
<	Boolean: Is less than (signed)
>	Boolean: Is greater than (signed)
=<	Boolean: Is equal or less (signed)
=>	Boolean: Is equal or greater (signed)
e	Symbol address; unary



## 7.0 ELECTRICAL CHARACTERISTICS

### 7.1. Absolute Maximum Ratings

Stresses in excess of the absolute maximum ratings can cause permanent damage to the device. These are absolute stress ratings only. Functional operation of the device is not implied at these or any other conditions in excess of those given in the remainder of Section 0. Exposure to absolute maximum ratings for extended periods can adversely affect device reliability.

Table 18: Absolute Maximum Ratings	
Ambient temperature under bias	-55 °C to +125 °C
Storage temperature	-65 °C to +150 °C
Voltage on V <sub>dd</sub> with respect to V <sub>ss</sub>	-0.3 V to +4.0 V
Voltage on all other pins with respect to V <sub>ss</sub> *	-0.3 V to (V <sub>dd</sub> + 0.3 V)
Total power dissipation	1 W
Max. current out of V <sub>ss</sub> pins	300 mA
Max. current into V <sub>dd</sub> pins	300 mA
Max. DC current into an input pin with internal protection diode forward biased	±500 µA
Max. allowable current per I/O pin	40 mA
ESD (Human Body Model) Supply pins	3 kV
ESD (Human Body Model) all non-supply pins	8 kV

\*Note: I/O pin voltages with respect to V<sub>ss</sub> may be exceeded if internal protection diode forward bias current is not exceeded.

### 7.2. DC Characteristics

(Operating temperature range: -55° C < T<sub>a</sub> < +125° C unless otherwise noted)

Symbol	Parameter	Conditions	Min	Typ*	Max	Units
V <sub>dd</sub>	Supply Voltage		2.7	-	3.6	V
V <sub>ih</sub> , V <sub>il</sub>	Logic High Logic Low		0.6 V <sub>dd</sub> V <sub>ss</sub>		V <sub>dd</sub> 0.3 V <sub>dd</sub>	V V
I <sub>il</sub>	Input Leakage Current	V <sub>in</sub> = V <sub>dd</sub> or V <sub>ss</sub>	-1.0		+1.0	µA
V <sub>oh</sub>	Output High Voltage	I <sub>oh</sub> = 10 mA, V <sub>dd</sub> = 3.3 V	2.85			V
V <sub>ol</sub>	Output Low Voltage	I <sub>ol</sub> = 10 mA, V <sub>dd</sub> = 3.3 V			0.4	V
I <sub>Bo</sub>	Brownout Detector Current			3.8		µA
I	Quiescent Current	RESn = 0V, BOEn = V <sub>dd</sub> , P <sub>0</sub> -P <sub>31</sub> =0V		600		nA

\*Note: Data in the Typical ("Typ") column is T<sub>a</sub> = 25 °C unless otherwise stated.

### 7.3. AC Characteristics

(Operating temperature range: -55° C < T<sub>a</sub> < +125° C unless otherwise noted)

Symbol	Parameter	Min	Typ*	Max	Units	Condition
F <sub>osc</sub>	External XI Frequency	DC	-	80	MHz	
	Oscillator Frequency	DC 13 8 4	- 20 12 -	80 33 20 8	MHz kHz MHz MHz	Direct drive (no PLL) RCSLOW RCFAST Crystal using PLL
C <sub>in</sub>	Input Capacitance		6	-	pF	

\*Note: Data in the Typical ("Typ") column is T<sub>a</sub> = 25 °C unless otherwise stated.

## 8.0 CURRENT CONSUMPTION CHARACTERISTICS

### 8.1. Typical Current Consumption of 8 Cogs

This figure shows the typical current consumption of the Propeller under various operating conditions duplicated across all cogs. Brown out circuitry and the Phase-Locked Loop were disabled for the duration of the test. Current consumption is substantially constant over the operational temperature range.

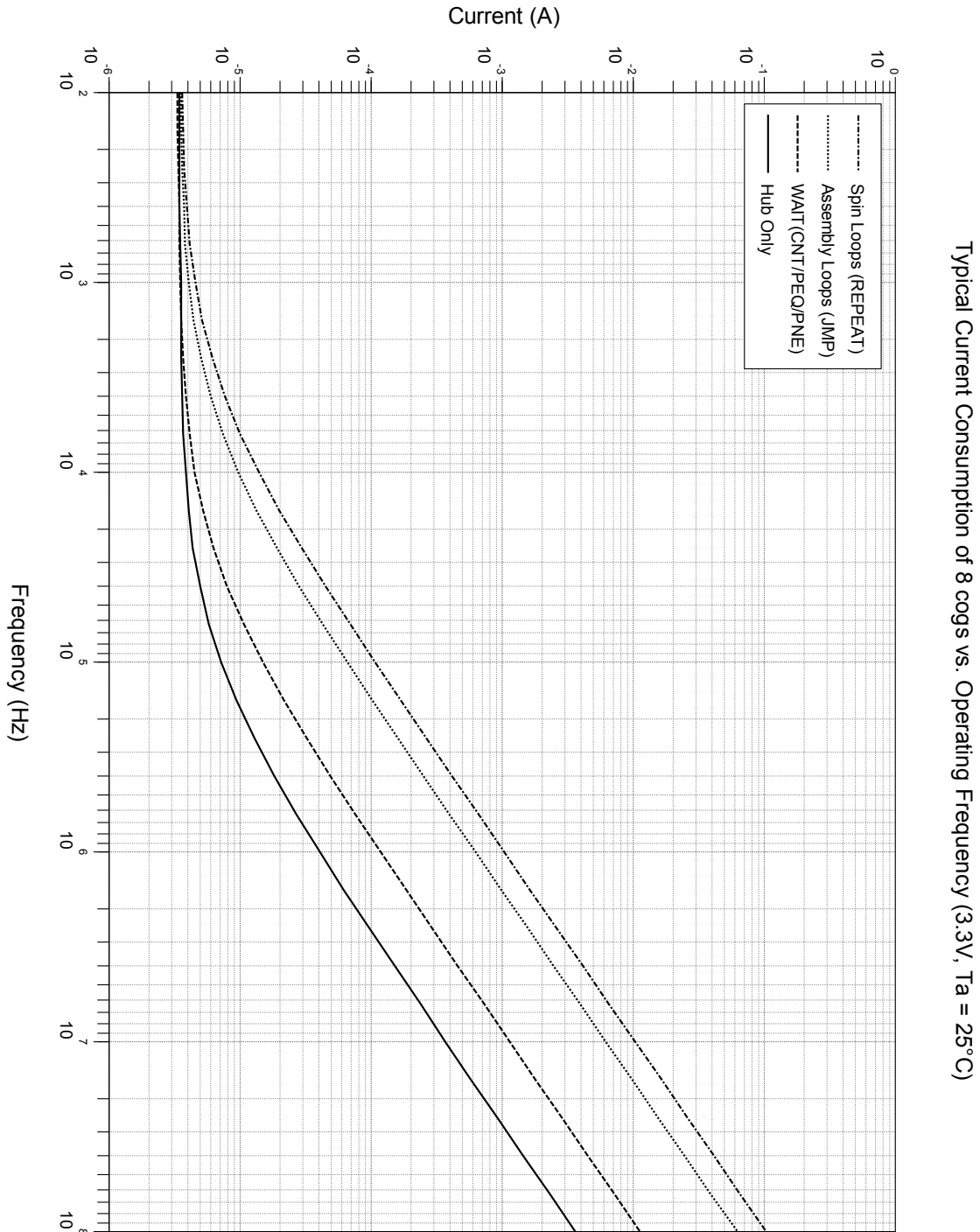

### 8.2. Typical Current of a Cog vs. Operating Frequency

This graph shows a cog’s typical current consumption under various conditions, in isolation of other sources of current within the Propeller chip.

Typical Current of a Cog vs. Operating Frequency (Vdd = 3.3 V, Ta = 25° C)

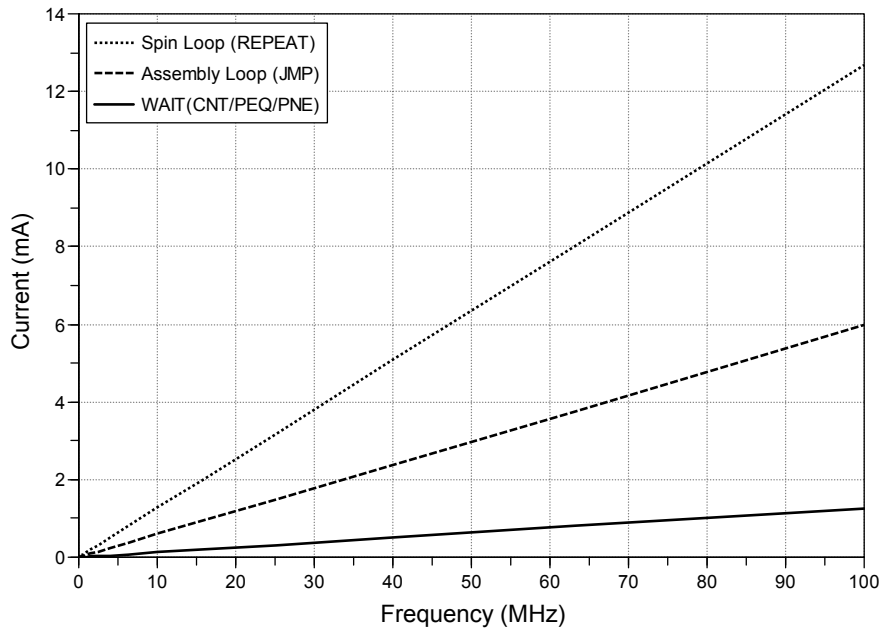

### 8.3. Typical PLL Current vs. VCO Frequency

This graph shows the typical amount of current consumed by a Phase-Locked Loop as a function of the frequency of the Voltage Controlled Oscillator which is 16 times the frequency of the input clock.

Typical PLL Current vs. VCO Frequency (Vdd = 3.3 V, Ta = 25° C)

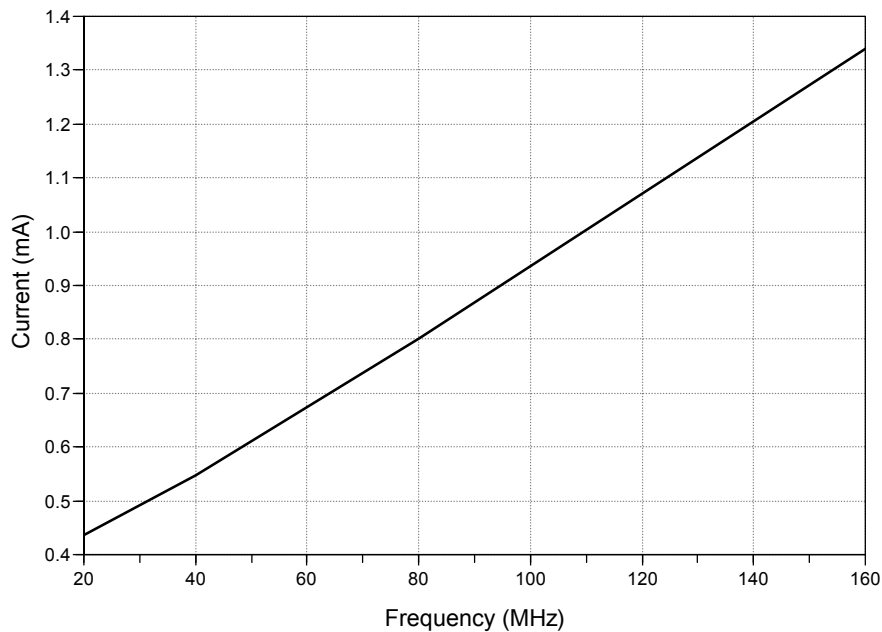

### 8.4. Typical Crystal Drive Current

This graph shows the current consumption of the crystal driver over a range of crystal frequencies and crystal settings, all data points above 25 MHz were obtained by using a resonator since the driver does not perform 3<sup>rd</sup> harmonic overtone driving required for crystals over 25 MHz.

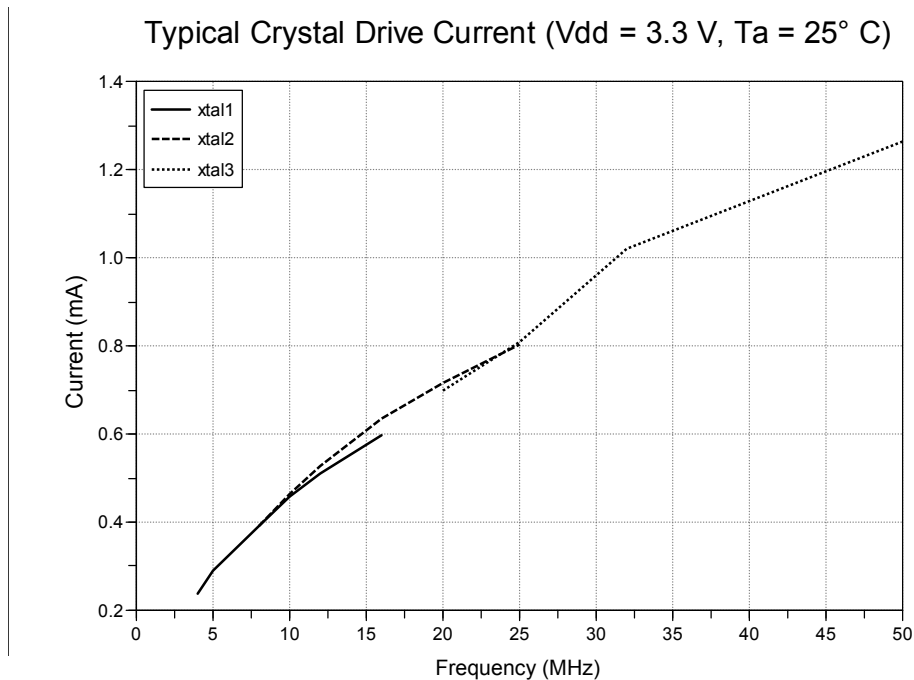

### 8.5. Cog and I/O Pin Relationship

The figure below illustrates the physical relationship between the cogs and I/O pins. While there can be a 1 to 1.5 ns propagation delay in output transitions between the shortest and longest paths, the purpose of the figure is to illustrate the length of leads and their associated parasitic capacitance. This capacitance increases the amount of energy required to transition a pin's state and therefore increases the current draw for toggling a pin. So, the current consumed by Cog 7 toggling P0 at 20 MHz will be greater than Cog 0 toggling P7 at 20 MHz. The amount of current consumed by transitioning a pin's state is dependent on many factors including: temperature, frequency of transitions, external load, and internal load. As mentioned, the internal load is dependent upon which cog and pin are used. Internal load current for room temperature toggling of a pin at 20 MHz for a Propeller in a DIP package varies on the order of 300 μA.

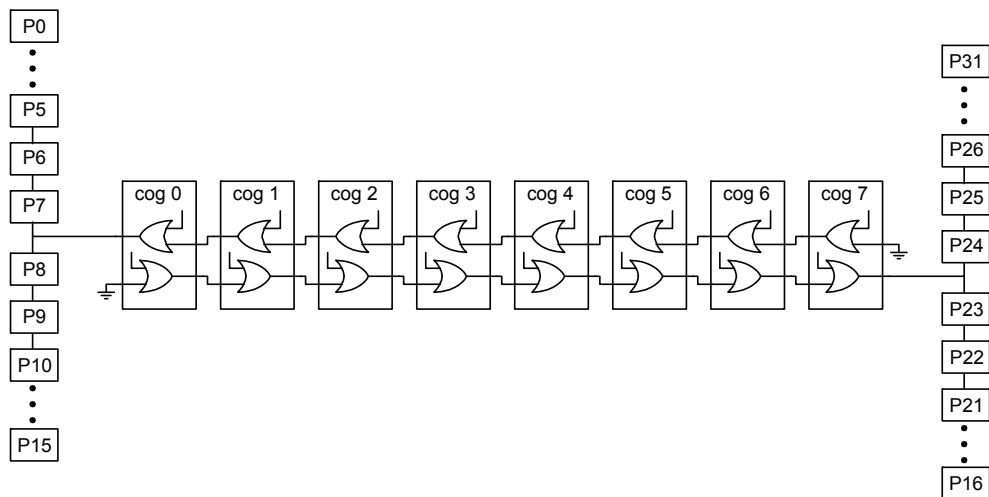

### 8.6. Current Profile at Various Startup Conditions

The diagrams below show the current profile for various startup conditions of the Propeller chip dependent upon the presence of an EEPROM and PC.

**Figure 9**

Boot Sequence Current Profile for no PC and no EEPROM (P31 held low and P29 not connected (same as held low)).

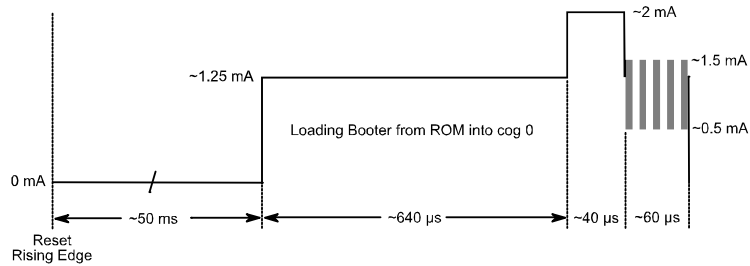

**Figure 10**

Boot Sequence Current Profile for PC (connected but idle) and no EEPROM. (P31 held high and P29 not connected).

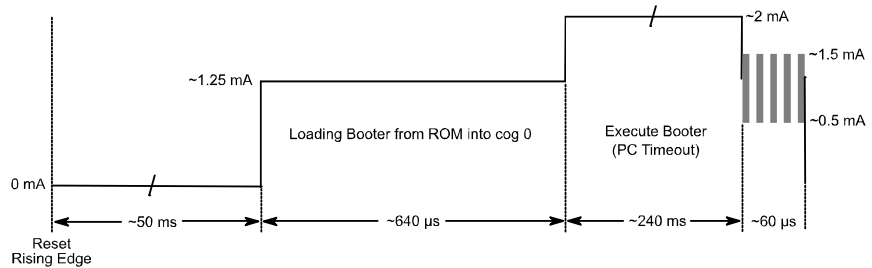

**Figure 11**

Boot Sequence Current Profile for no PC and no EEPROM (P31 held low and P29 held high).

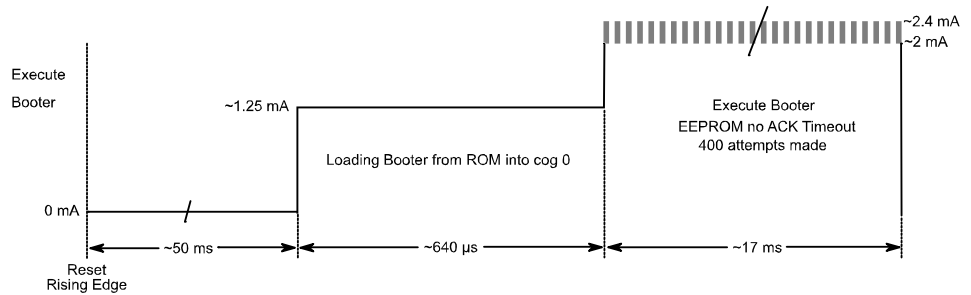

**Figure 12**

Boot Sequence Current Profile for no PC and EEPROM (P31 held low and P29 connected to EEPROM SDA).

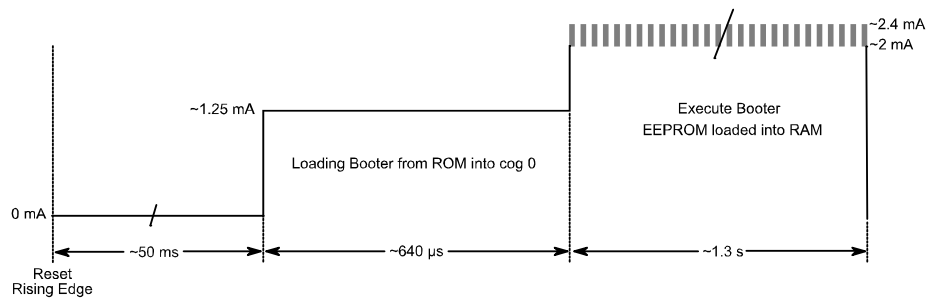

**Figure 13**

Boot Sequence Current Profile for PC (connected but idle) and EEPROM (P31 held high and P29 connected to EEPROM SDA).

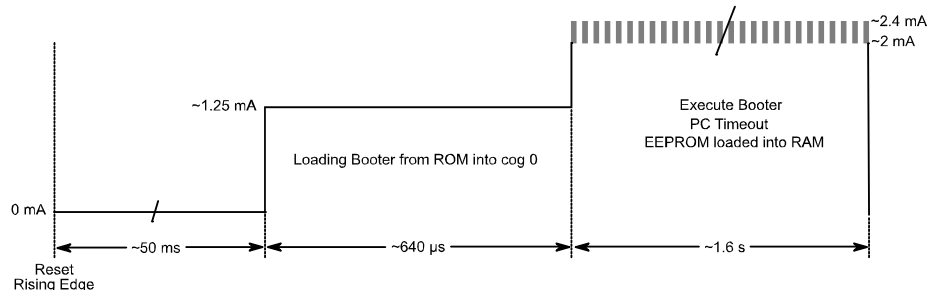

## 9.0 TEMPERATURE CHARACTERISTICS

### 9.1 Internal Oscillator Frequency as a Function of Temperature

While the internal oscillator frequency is variable due to process variation, the rate of change as a function of temperature when normalized provides a chip invariant ratio which can be used to calculate the oscillation frequency when the ambient temperature is other than 25 °C (the temperature to which the graph was normalized). The absolute frequency at 25 °C varied from 13.26 to 13.75 MHz in the sample set. The section of the graph which has a white background is the military range of temperature; the sections in grey represent data which is beyond military temperature specification.

RCAFAST Normalized Frequency vs Temperature

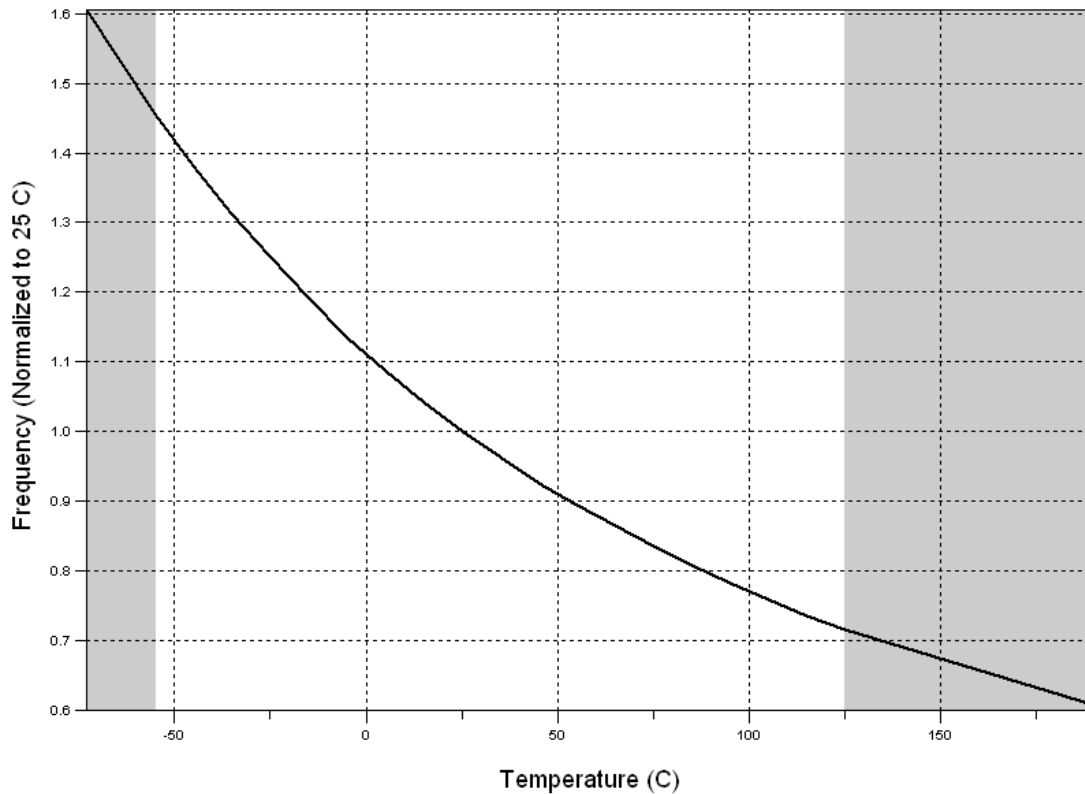

### 9.2. Fastest Operating Frequency as a Function of Temperature

The following graph represents a small sample average of a Propeller chip’s fastest operating range. The test was performed in a forced air chamber using code run on all eight cogs, multiple video generators, and counter modules. A frequency was considered successful if the demo ran without fault for one minute. The curves represent an aggressive testing procedure (averaged, forced air, one minute time limit); therefore the designer must de-rate the curve to arrive at a stable frequency for a particular application. Again the grayed regions represent temperatures beyond the military temperature range.

#### Fastest Frequency vs Temperature

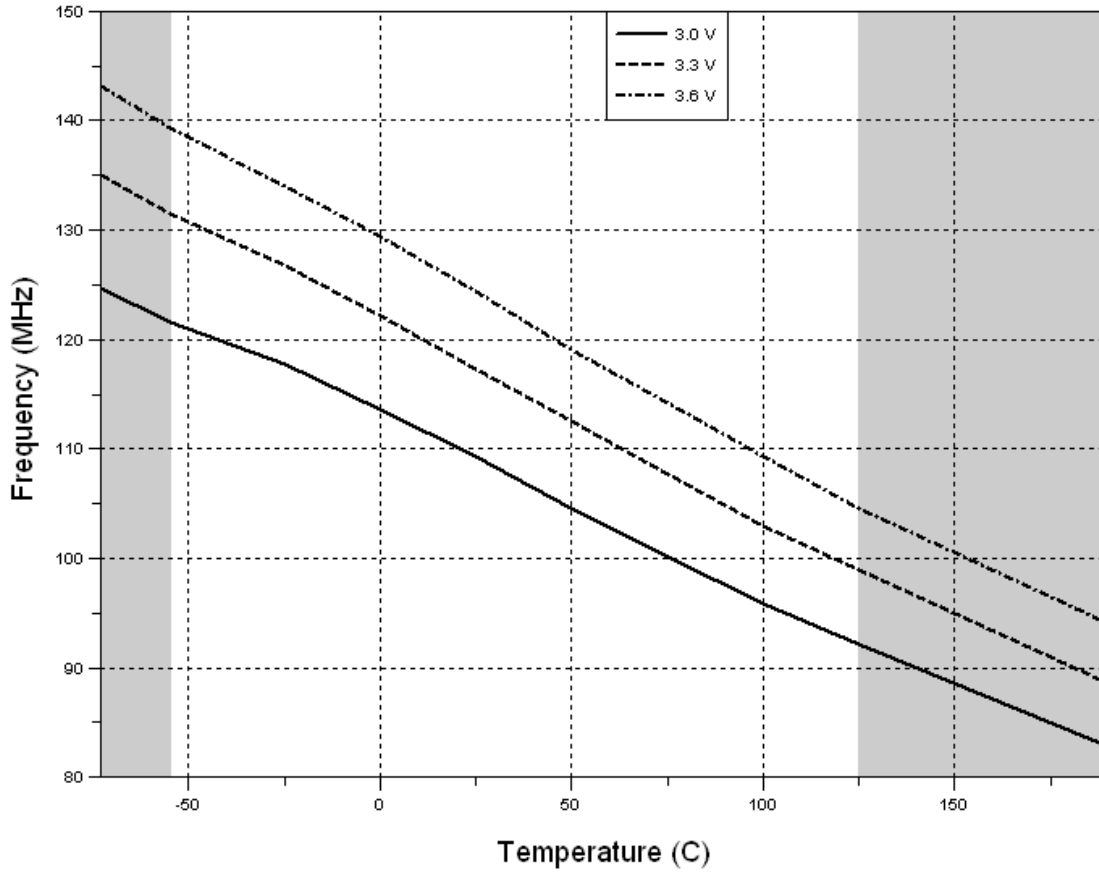

### 9.3. Current Consumption as a Function of Temperature

The following graph demonstrates the current consumption of the Propeller as a function of temperature. It is clear from the graph that current consumption is nearly independent of temperature over the entire military temperature range.

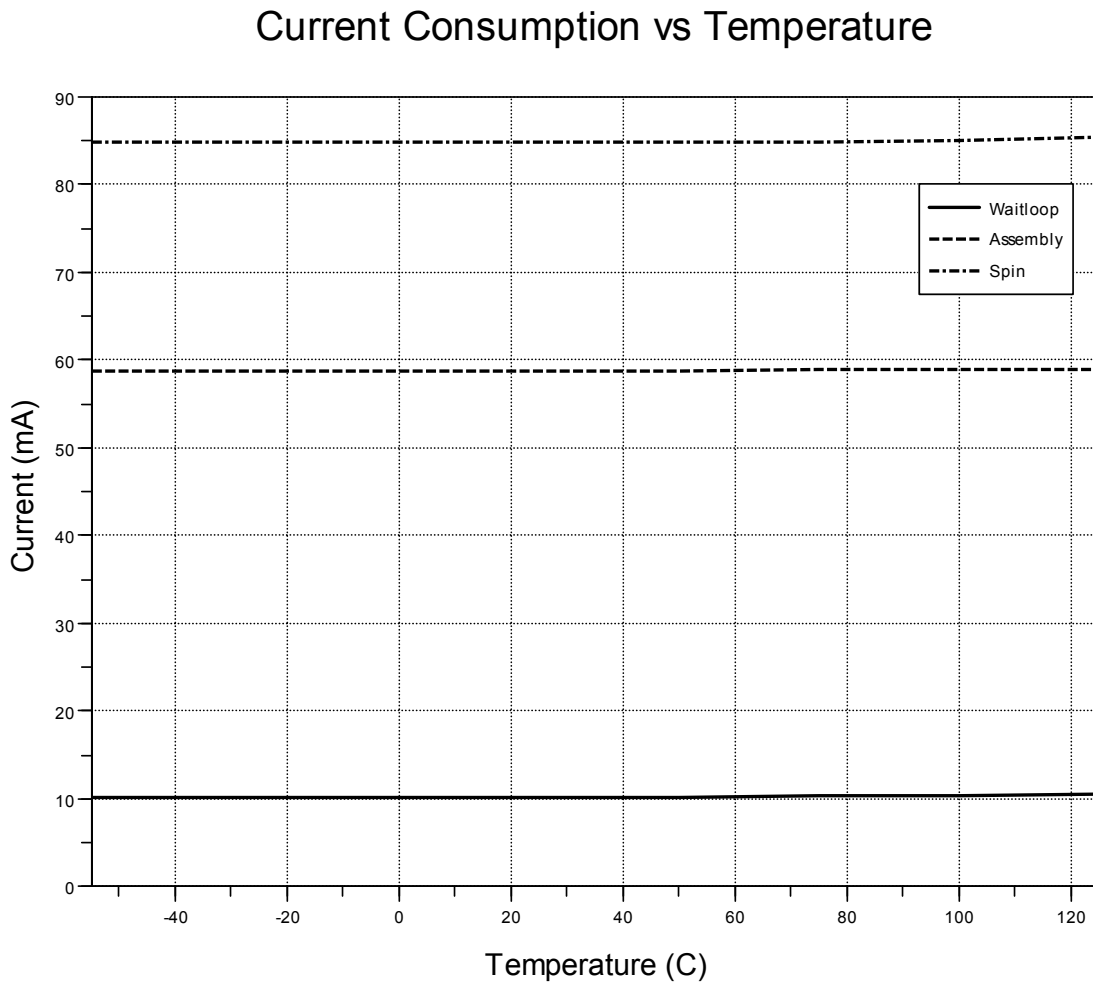



### 10.0 PACKAGE DIMENSIONS

#### 10.1. P8X32A-D40 (40-pin DIP)

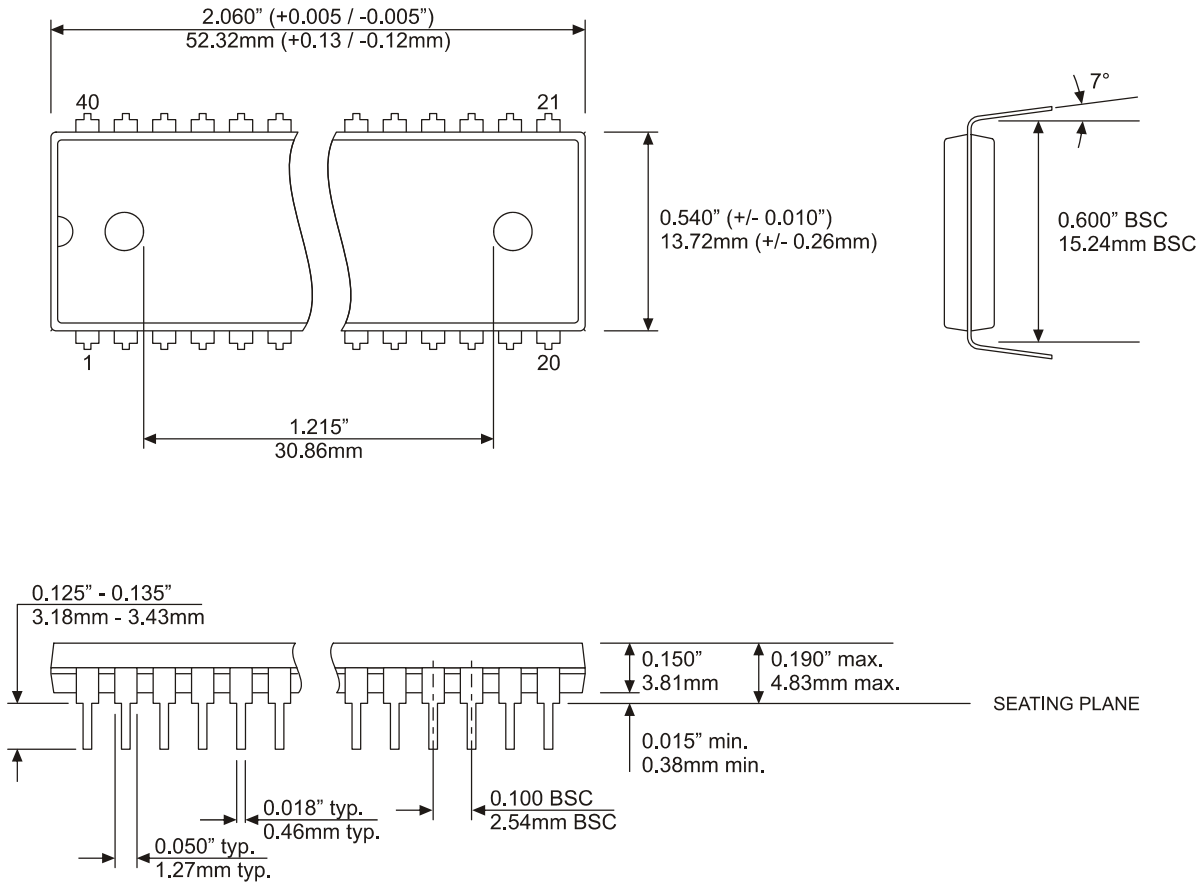

### 10.2. P8X32A-Q44 (44-pin LQFP)

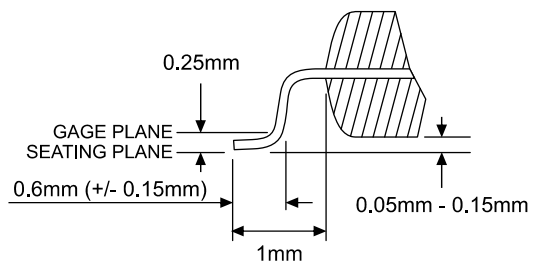
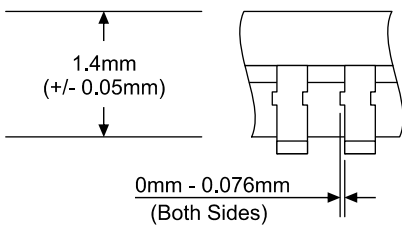
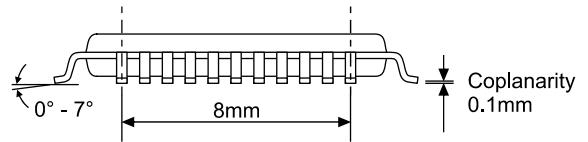
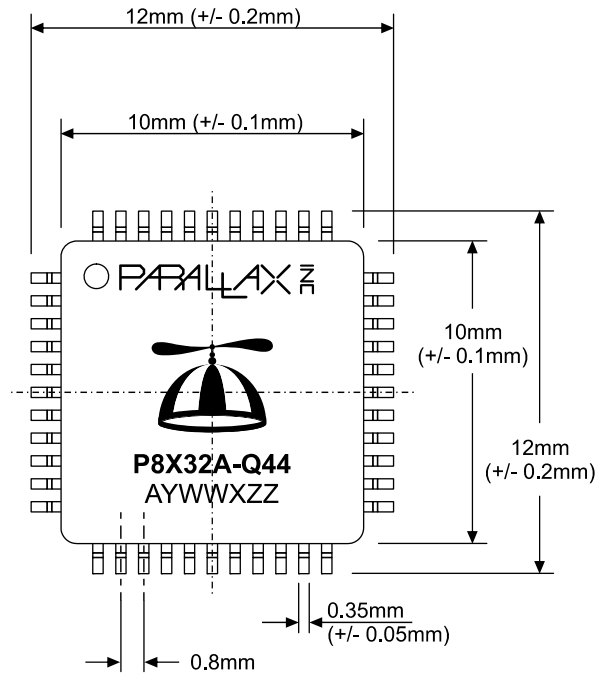
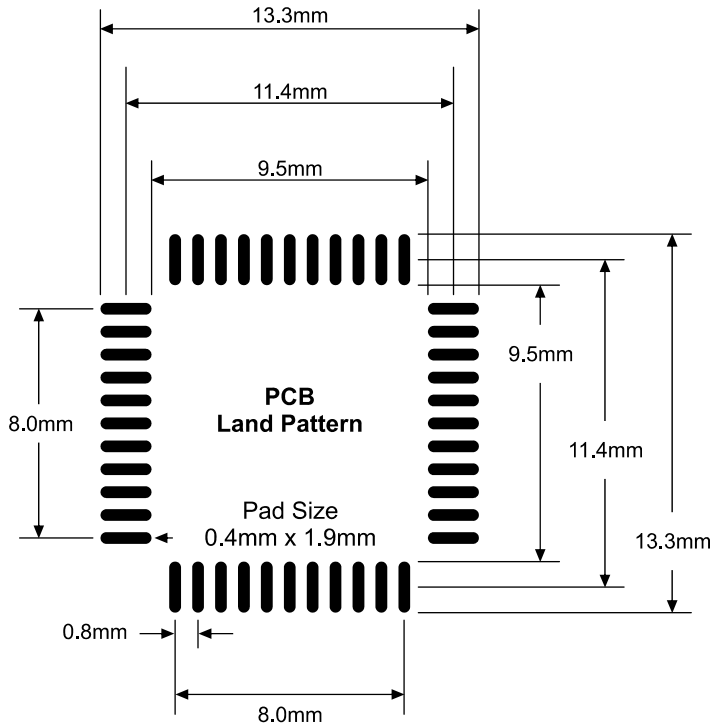

### 10.3. P8X32A-M44 (44-pin QFN)

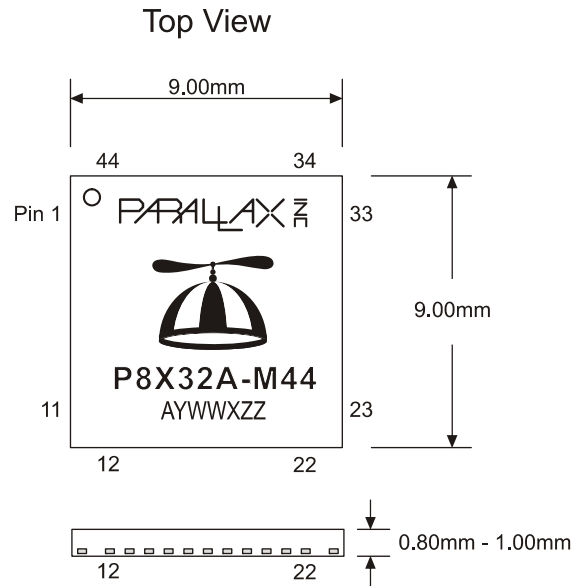
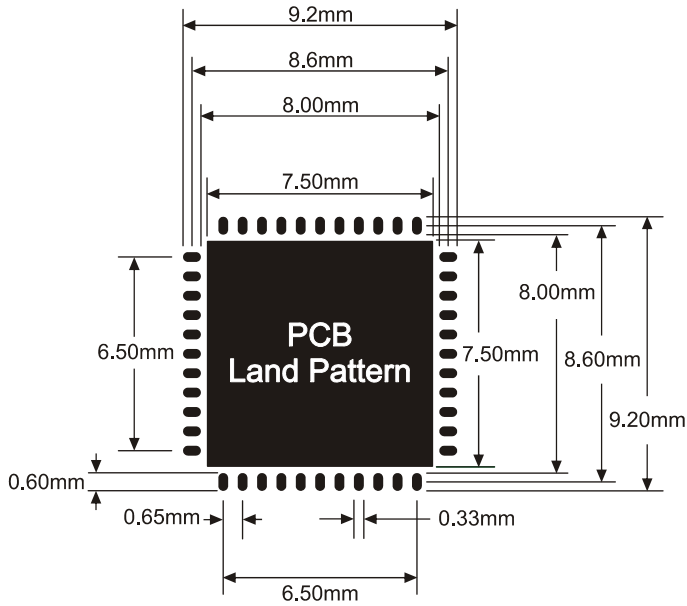

**Stencil Pattern**  
 Drawing is larger than actual size  
 Typical shrink is 0.05mm

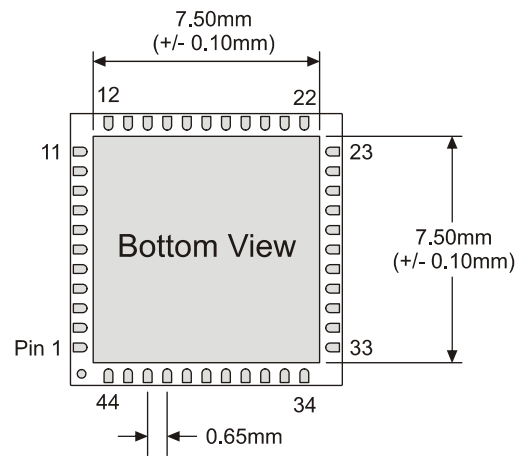
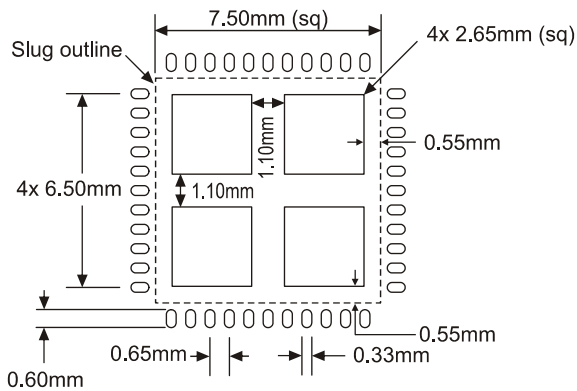
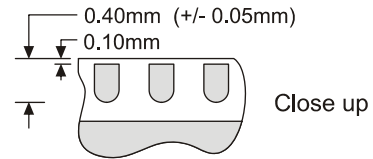

## 11.0 MANUFACTURING INFO

### 11.1. Reflow Peak Temperature

Package Type	Reflow Peak Temp.
DIP	255+5/-0 °C
LQFP	255+5/-0 °C
QFN	255+5/-0 °C

### 11.2. Green/RoHS Compliance

All Parallax Semiconductor Propeller P8X32A chip models are certified Green/RoHS Compliant. RoHS, Green, and ISO certificates are available online at [www.parallaxsemiconductor.com](http://www.parallaxsemiconductor.com).

## 12.0 REVISION HISTORY

### 12.1.1. Changes for Version 1.1:

Section 10.3: P8X32A-M44 (44-pin QFN). Image replaced to add stencil pattern diagram. New section inserted: 4.8 Assembly Instruction Execution Stages. Contact Information updated.

### 12.1.2. Changes for Version 1.2:

Section 6.4: Modified table entries for ADD, ADDABS, ADDS, ADDSX, ADDX, CMP, CMPS, CMPSX, CMPX, COGID, COGINIT, COGSTOP, LOCKCLR, LCOKNEW, LOCKRET, LOCKSET, MAX, MAXS, MIN, MINS, SUB, SUBABS, SUBS, SUBSX, SUBX, SUMC, SUMNC, SUMNZ, SUMZ, TEST, TJNZ, TJZ. Section 4.5 updated. Section 5.1: new sentence added at end of paragraph. Section 5.2: new sentence added at end of first paragraph.

### 12.1.3. Changes for Version 1.3

Throughout: updated logo and contact information for Parallax Inc., dba Parallax Semiconductor. Section 7.1: footnote added to Table 18: Absolute Maximum Ratings.

### 12.1.4. Changes for Version 1.4

Section 1.0 changes: 1.3: Key Features and Benefits revised; former sections 1.4 , 1.6 removed. Section 4.4: updated all references to hub timing and replaced both timing diagrams. Section 4.8: reference to hub timing updated. Section 6.4: timing for hub instructions and WAITxxx instructions revised. Former Section 7.0: Propeller Demo Board schematic removed.

## Parallax Semiconductor Contact Information

**Parallax Semiconductor**  
**599 Menlo Drive**  
**Rocklin, CA 95765**  
**USA**

**Phone: (916) 632-4664**  
**Fax: (916) 624-8003**

**sales@parallaxsemiconductor.com**  
**support@parallaxsemiconductor.com**  
**www.parallaxsemiconductor.com**  
**http://obex.parallax.com**

Parallax, Inc., dba Parallax Semiconductor, makes no warranty, representation or guarantee regarding the suitability of its products for any particular purpose, nor does Parallax, Inc., dba Parallax Semiconductor, assume any liability arising out of the application or use of any product, and specifically disclaims any and all liability, including without limitation consequential or incidental damages even if Parallax, Inc., dba Parallax Semiconductor, has been advised of the possibility of such damages. Reproduction of this document in whole or in part is prohibited without the prior written consent of Parallax, Inc., dba Parallax Semiconductor.

Copyright © 2011 Parallax, Inc. dba Parallax Semiconductor. All rights are reserved.

Propeller and Parallax Semiconductor are trademarks of Parallax, Inc.

# Mouser Electronics

Authorized Distributor

Click to View Pricing, Inventory, Delivery & Lifecycle Information:

[Parallax:](#)

[P8X32A-M44](#) [P8X32A-Q44](#)