

Choke Coils

Series: **Pin terminal**
 Type: **06D, 09D, 10D, 12D, 16B, 18B**
10E, 12E, 15E, 18E

Japan
 Singapore
 Indonesia



Pin terminal inductors featuring small size and high performance

Industrial Property: Patents 1 (pending)

■ Features

- Adoption of High μ and High B_m ferrite cores
- Wide inductor range
- Magnetic shield type (E Type)

■ Recommended Applications

- CTV, VTR, Audio, PC, Facsimiles



■ Explanation of Part Numbers

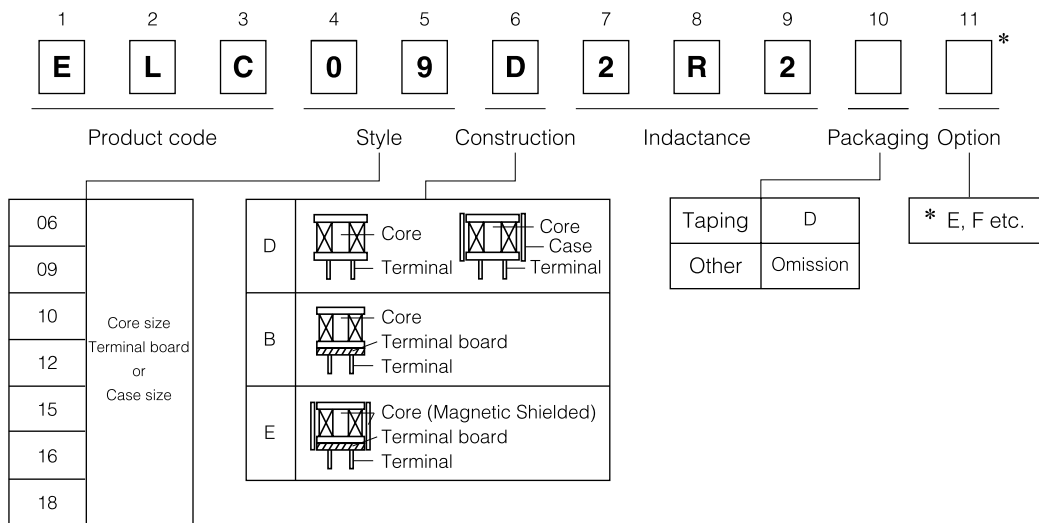

■ Available I-L Characteristics

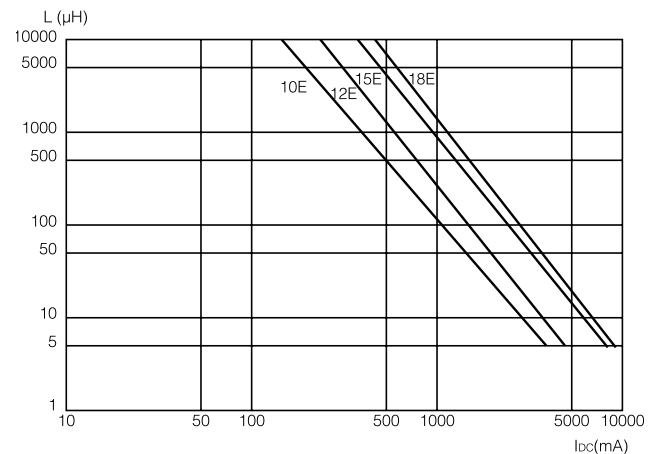
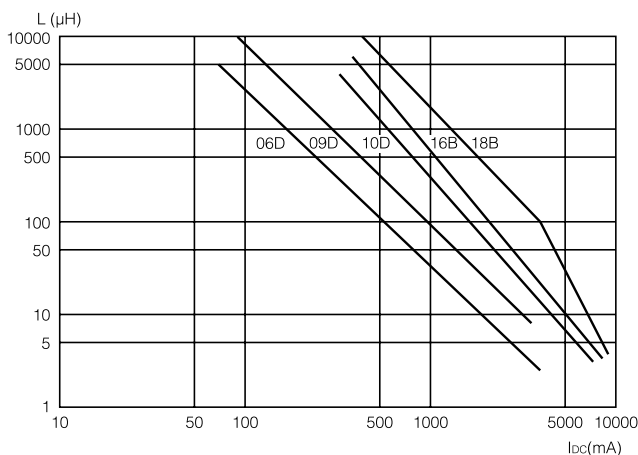

Examples Type 06D

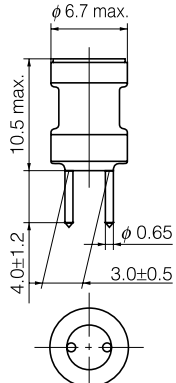
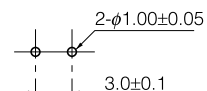
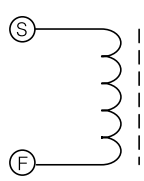
	Part No.	Inductance (μH)	Tolerance (%)	Test Freq. (kHz)	DCR.(Ω) [at 20 °C] **(Tol.±30 %) (Tol.±20 %)	*IDC. [at 20 °C] (A)max.
[Dimensions in mm] (not to scale) 	ELC06D2R2E	2.2	±20	10	**0.026	3.400
	ELC06D2R7E	2.7			**0.028	3.200
	ELC06D3R3E	3.3			**0.027	3.000
	ELC06D3R9E	3.9			**0.030	2.800
	ELC06D4R7E	4.7			**0.033	2.600
	ELC06D5R6E	5.6			**0.035	2.400
	ELC06D6R8E	6.8			0.041	2.000
	ELC06D8R2E	8.2			0.048	1.800
	ELC06D100E	10.0			0.052	1.700
	ELC06D120E	12.0			0.054	1.650
	ELC06D150E	15.0			0.059	1.500
	ELC06D180E	18.0			0.065	1.250
Recommended PWB piercing plan 	ELC06D220E	22.0	±10	10	0.076	1.200
	ELC06D270E	27.0			0.083	0.950
	ELC06D330E	33.0			0.100	0.900
	ELC06D390E	39.0			0.105	0.850
	ELC06D470E	47.0			0.120	0.800
	ELC06D560E	56.0			0.140	0.750
	ELC06D680E	68.0			0.150	0.700
	ELC06D820E	82.0			0.210	0.550
	ELC06D101E	100.0			0.230	0.500
	ELC06D121E	120.0			0.260	0.490
	ELC06D151E	150.0			0.370	0.450
	ELC06D181E	180.0			0.420	0.400
Connection Schematic 	ELC06D221E	220.0	±10	10	0.550	0.360
	ELC06D271E	270.0			0.650	0.350
	ELC06D331E	330.0			0.740	0.300
	ELC06D391E	390.0			0.950	0.270
	ELC06D471E	470.0			1.080	0.240
	ELC06D561E	560.0			1.220	0.220
	ELC06D681E	680.0			1.590	0.210
	ELC06D821E	820.0			1.760	0.180
	ELC06D102E	1000.0			2.490	0.160
	ELC06D122E	1200.0			2.760	0.150
	ELC06D152E	1500.0			3.240	0.130
	ELC06D182E	1800.0			4.560	0.120
ELC06D222E	2200.0	5.180	0.110			
ELC06D272E	2700.0	6.080	0.100			
ELC06D332E	3300.0	8.800	0.100			
ELC06D392E	3900.0	9.470	0.080			
ELC06D472E	4700.0	10.900	0.075			
ELC06D562E	5600.0	12.300	0.070			

* Allowable DC Current:Smaller current value either when the inductance of -10 %max. changed, or when the temperature of 45 k max. rised.

Examples Type 09D

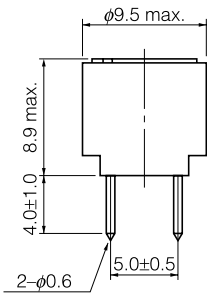
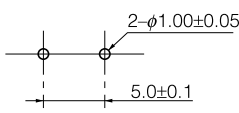
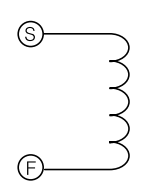
	Part No.	Inductance (μH)	Tolerance (%)	Test Freq. (kHz)	DCR.(Ω) [at 20 °C] (Tol.±20 %)	*IDC. [at 20 °C] (A)max.
<p>[Dimensions in mm] (not to scale)</p> 	ELC09D2R2□F	2.2	±20	10	0.012	3.50
	ELC09D2R7□F	2.7			0.013	3.30
	ELC09D3R3□F	3.3			0.015	3.20
	ELC09D3R9□F	3.9			0.016	3.10
	ELC09D4R7□F	4.7			0.018	3.00
	ELC09D5R6□F	5.6			0.019	2.90
	ELC09D6R8□F	6.8			0.021	2.80
	ELC09D8R2□F	8.2			0.024	2.60
	ELC09D100□F	10.0			0.027	2.50
	ELC09D120□F	12.0			0.031	2.30
	ELC09D150□F	15.0			0.035	2.10
	ELC09D180□F	18.0			0.038	2.00
	ELC09D220□F	22.0			0.051	1.80
	ELC09D270□F	27.0			0.058	1.60
	ELC09D330□F	33.0			0.081	1.40
	ELC09D390□F	39.0			0.087	1.30
	ELC09D470□F	47.0			0.110	1.20
	ELC09D560□F	56.0			0.130	1.10
	ELC09D680□F	68.0			0.140	1.00
	<p>Recommended PWB piercing plan</p> 	ELC09D820□F			82.0	±10
ELC09D101□F		100.0	0.200	0.82		
ELC09D121□F		120.0	0.250	0.77		
ELC09D151□F		150.0	0.320	0.74		
ELC09D181□F		180.0	0.360	0.61		
ELC09D221□F		220.0	0.410	0.58		
ELC09D271□F		270.0	0.500	0.52		
ELC09D331□F		330.0	0.650	0.49		
ELC09D391□F		390.0	0.860	0.46		
ELC09D471□F		470.0	0.980	0.39		
ELC09D561□F		560.0	1.100	0.36		
ELC09D681□F		680.0	1.400	0.34		
ELC09D821□F		820.0	1.600	0.30		
ELC09D102□F		1000.0	2.100	0.28		
ELC09D122□F		1200.0	2.400	0.23		
ELC09D152□F		1500.0	2.800	0.21		
ELC09D182□F		1800.0	3.800	0.19		
ELC09D222□F		2200.0	4.400	0.17		
ELC09D272□F		2700.0	6.100	0.16		
ELC09D332□F		3300.0	7.000	0.14		
ELC09D392□F	3900.0	8.000	0.13			
ELC09D472□F	4700.0	11.200	0.12			
ELC09D562□F	5600.0	12.600	0.11			
ELC09D682□F	6800.0	14.400	0.10			
ELC09D822□F	8200.0	16.600	0.09			
ELC09D103□F	10000.0	18.800	0.08			
<p>Connection Schematic</p> 						

*Allowable DC Current:Smaller current value either when the inductance of -10 %max. changed, or when the temperaturer of 45k max. rised.

Design and specifications are each subject to change without notice. Ask factory for the current technical specifications before purchase and/or use. Should a safety concern arise regarding this product, please be sure to contact us immediately.

Examples Type 10D

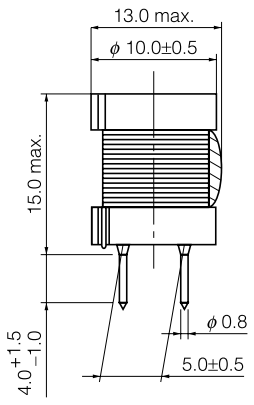
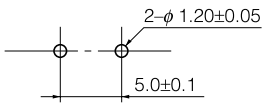
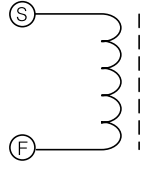
	Part No.	Inductance (μH)	Tolerance (%)	Test Freq. (kHz)	DCR.(Ω) [at 20°C] (Tol.±20 %)	*IDC. [at 20°C] (A)max.
<p>[Dimensions in mm] (not to scale)</p>  <p>Recommended PWB piercing plan</p>  <p>Connection Schematic</p> 	ELC10D2R2E	2.2	±20	10	0.014	5.90
	ELC10D2R7E	2.7			0.015	5.50
	ELC10D3R3E	3.3			0.016	5.20
	ELC10D3R9E	3.9			0.018	4.80
	ELC10D4R7E	4.7			0.019	4.60
	ELC10D5R6E	5.6			0.021	4.30
	ELC10D6R8E	6.8			0.022	4.20
	ELC10D8R2E	8.2			0.024	4.00
	ELC10D100E	10.0			0.026	3.90
	ELC10D120E	12.0			0.028	3.80
	ELC10D150E	15.0			0.033	3.50
	ELC10D180E	18.0			0.036	3.40
	ELC10D220E	22.0			0.040	3.20
	ELC10D270E	27.0			0.044	3.00
	ELC10D330E	33.0			0.051	2.80
	ELC10D390E	39.0	0.054		2.70	
	ELC10D470E	47.0	0.060		2.50	
	ELC10D560E	56.0	0.067		2.30	
	ELC10D680E	68.0	0.075		2.10	
	ELC10D820E	82.0	0.095		1.80	
	ELC10D101E	100.0	0.110		1.70	
	ELC10D121E	120.0	0.120		1.60	
	ELC10D151E	150.0	0.160		1.40	
	ELC10D181E	180.0	0.180		1.30	
	ELC10D221E	220.0	0.210		1.10	
	ELC10D271E	270.0	0.280		1.00	
	ELC10D331E	330.0	0.320		0.90	
	ELC10D391E	390.0	0.400		0.80	
	ELC10D471E	470.0	0.450		0.70	
	ELC10D561E	560.0	0.560		0.68	
	ELC10D681E	680.0	0.660		0.64	
	ELC10D821E	820.0	0.800		0.55	
	ELC10D102E	1000.0	1.000		0.50	
ELC10D122E	1200.0	1.200	0.45			
ELC10D152E	1500.0	1.500	0.42			
ELC10D182E	1800.0	1.800	0.40			
ELC10D222E	2200.0	2.100	0.36			
ELC10D272E	2700.0	2.700	0.32			
ELC10D332E	3300.0	3.200	0.28			
ELC10D392E	3900.0	3.500	0.26			
			±10			

*Allowable DC Current:Smaller current value either when the inductance of -10 %max. changed, or when the temperatuer of 45k max. rised.

■ Examples Type 12D

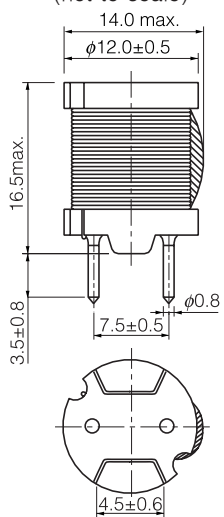
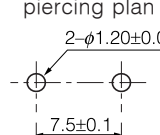
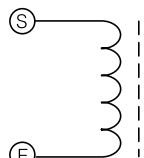
	Part No.	Inductance (μH)	Tolerance (%)	Test Freq. (kHz)	DCR (Ω) [at 20 °C] (Tol. ±20 %)	*IDC. [at 20 °C] (A)max.
<p>[Dimensions in mm] (not to scale)</p>  <p>Recommended PWB piercing plan</p>  <p>Connection Schematic</p> 	ELC12D101E	100	±10	10	0.150	1.90
	ELC12D121E	120			0.170	1.78
	ELC12D151E	150			0.190	1.67
	ELC12D181E	180			0.210	1.58
	ELC12D221E	220			0.230	1.55
	ELC12D271E	270			0.270	1.44
	ELC12D331E	330			0.300	1.34
	ELC12D391E	390			0.330	1.32
	ELC12D471E	470			0.380	1.25
	ELC12D561E	560			0.420	1.15
	ELC12D681E	680			0.460	0.98
	ELC12D821E	820			0.650	0.94
	ELC12D102E	1000			0.720	0.87
	ELC12D122E	1200			0.830	0.86
	ELC12D152E	1500			1.270	0.64
	ELC12D182E	1800			1.330	0.63
	ELC12D222E	2200			1.500	0.60
	ELC12D272E	2700			1.890	0.54
	ELC12D332E	3300			2.370	0.48
	ELC12D392E	3900			2.830	0.45
ELC12D472E	4700	3.190	0.41			
ELC12D562E	5600	4.080	0.34			
ELC12D682E	6800	5.740	0.29			
ELC12D822E	8200	6.340	0.28			
ELC12D103E	10000	7.200	0.27			

*Allowable DC Current: Smaller current value either when the inductance of -10 % max. changed, or when the temperature of 45k max. risen.

Examples Type 16B

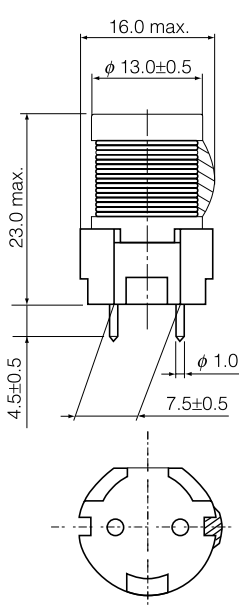
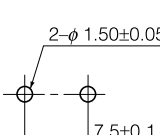
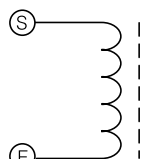
	Part No.	Inductance (μH)	Tolerance (%)	Test Freq. (kHz)	DCR.(Ω) [at 20°C] **(Tol.±30 %) (Tol.±20 %)	*IDC. [at 20°C] (A)max.
<p>[Dimensions in mm] (not to scale)</p>  <p>Recommended PWB piercing plan</p>  <p>Connection Schematic</p> 	ELC16B3R3L	3.3	±25	10	**0.012	8.50
	ELC16B3R9L	3.9			**0.013	8.00
	ELC16B4R7L	4.7			**0.015	7.80
	ELC16B5R6L	5.6	±20		**0.016	7.40
	ELC16B6R8L	6.8			0.018	6.70
	ELC16B8R2L	8.2			0.019	6.10
	ELC16B100L	10.0			0.022	5.60
	ELC16B120L	12.0			0.023	5.50
	ELC16B150L	15.0			0.026	5.40
	ELC16B180L	18.0			0.028	5.10
	ELC16B220L	22.0			0.031	4.60
	ELC16B270L	27.0			0.034	4.30
	ELC16B330L	33.0			0.039	4.00
	ELC16B390L	39.0	0.042		3.90	
	ELC16B470L	47.0	0.045		3.80	
	ELC16B560L	56.0	0.051		3.40	
	ELC16B680L	68.0	0.057		3.20	
	ELC16B820L	82.0	0.064		3.00	
	ELC16B101L	100.0	0.072		2.60	
	ELC16B121L	120.0	0.080		2.50	
	ELC16B151L	150.0	0.103		2.20	
	ELC16B181L	180.0	0.115		2.10	
	ELC16B221L	220.0	0.130		1.90	
	ELC16B271L	270.0	0.170		1.60	
	ELC16B331L	330.0	0.200		1.50	
	ELC16B391L	390.0	0.250		1.30	
	ELC16B471L	470.0	0.280		1.20	
	ELC16B561L	560.0	0.380		1.10	
	ELC16B681L	680.0	0.430		1.00	
	ELC16B821L	820.0	0.580		0.88	
	ELC16B102L	1000.0	0.660		0.85	
	ELC16B122L	1200.0	0.740		0.82	
	ELC16B152L	1500.0	0.870		0.74	
ELC16B182L	1800.0	1.220	0.60			
ELC16B222L	2200.0	1.380	0.57			
ELC16B272L	2700.0	1.570	0.54			
ELC16B332L	3300.0	2.000	0.47			
ELC16B392L	3900.0	2.400	0.42			
ELC16B472L	4700.0	3.300	0.36			
ELC16B562L	5600.0	3.700	0.34			
ELC16B682L	6800.0	4.200	0.32			
ELC16B822L	8200.0	5.600	0.28			
ELC16B103L	10000.0	6.400	0.26			
ELC16B123L	12000.0	7.300	0.24			

*Refer to former page

Examples Type 18B

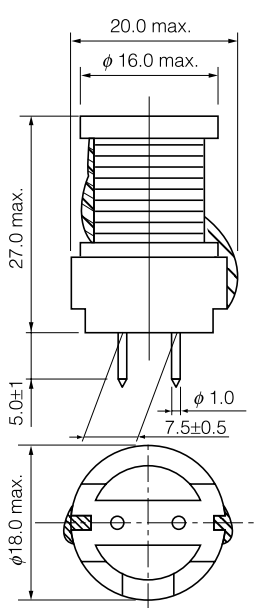
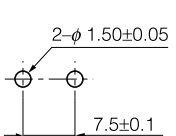
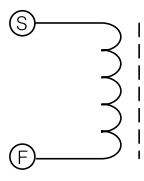
	Part No.	Inductance (μH)	Tolerance (%)	Test Freq. (kHz)	DCR (Ω) [at 20°C] (Tol. ±20 %)	*IDC. [at 20°C] (A)max.
<p>[Dimensions in mm] (not to scale)</p>  <p>Recommended PWB piercing plan</p>  <p>Connection Schematic</p> 	ELC18B3R3L	3.3	±20	10	0.010	8.50
	ELC18B3R9L	3.9			0.011	8.00
	ELC18B4R7L	4.7			0.012	7.80
	ELC18B5R6L	5.6			0.013	7.40
	ELC18B6R8L	6.8			0.015	6.80
	ELC18B8R2L	8.2			0.016	6.60
	ELC18B100L	10.0			0.017	6.50
	ELC18B120L	12.0			0.018	6.00
	ELC18B150L	15.0			0.021	5.90
	ELC18B180L	18.0			0.022	5.60
	ELC18B220L	22.0	0.025		5.40	
	ELC18B270L	27.0	0.028		4.80	
	ELC18B330L	33.0	0.030		4.60	
	ELC18B390L	39.0	0.033		4.40	
	ELC18B470L	47.0	0.037		4.30	
	ELC18B560L	56.0	0.040		4.20	
	ELC18B680L	68.0	0.046		4.00	
	ELC18B820L	82.0	0.051		3.70	
	ELC18B101L	100.0	0.057		3.20	
	ELC18B121L	120.0	0.065		3.00	
	ELC18B151L	150.0	0.072		2.70	
	ELC18B181L	180.0	0.082		2.60	
	ELC18B221L	220.0	0.090		2.40	
	ELC18B271L	270.0	0.110		2.20	
	ELC18B331L	330.0	0.130		1.90	
	ELC18B391L	390.0	0.150		1.80	
	ELC18B471L	470.0	0.210		1.60	
	ELC18B561L	560.0	0.230		1.50	
	ELC18B681L	680.0	0.260		1.40	
	ELC18B821L	820.0	0.340		1.30	
	ELC18B102L	1000.0	0.390		1.10	
	ELC18B122L	1200.0	0.440		1.00	
	ELC18B152L	1500.0	0.580		0.85	
	ELC18B182L	1800.0	0.650		0.84	
ELC18B222L	2200.0	0.880	0.75			
ELC18B272L	2700.0	1.200	0.68			
ELC18B332L	3300.0	1.400	0.60			
ELC18B392L	3900.0	1.500	0.57			
ELC18B472L	4700.0	1.700	0.55			
ELC18B562L	5600.0	2.200	0.46			
ELC18B682L	6800.0	2.800	0.45			
ELC18B822L	8200.0	3.100	0.41			
ELC18B103L	10000.0	3.900	0.36			

*Refer to former page

■ Examples Type 10E□□□L

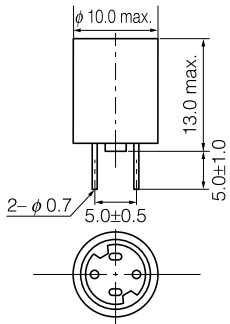
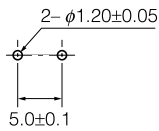
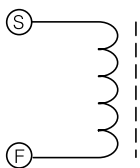
	Part No.	Inductance (μH)	Tolerance (%)	Test Freq. (kHz)	DCR.(Ω) [at 20°C] (Tol.±20 %)	*IDC. [at 20°C] (A)max.
[Dimensions in mm] (not to scale) 	ELC10E3R9L	3.9	±20	10	0.024	2.90
	ELC10E4R7L	4.7			0.027	2.80
	ELC10E5R6L	5.6			0.030	2.70
	ELC10E6R8L	6.8			0.032	2.60
	ELC10E8R2L	8.2			0.035	2.50
	ELC10E100L	10.0			0.038	2.40
	ELC10E120L	12.0			0.040	2.30
	ELC10E150L	15.0			0.046	2.20
	ELC10E180L	18.0			0.049	2.10
	Recommended PWB piercing plan 	ELC10E220L			22.0	±15
ELC10E270L		27.0	0.062	1.90		
ELC10E330L		33.0	0.068	1.80		
ELC10E390L		39.0	0.074	1.70		
ELC10E470L		47.0	0.098	1.50		
ELC10E560L		56.0	0.120	1.30		
ELC10E680L		68.0	0.150	1.20		
ELC10E820L		82.0	0.190	1.00		
ELC10E101L		100.0	0.210	0.96		
ELC10E121L		120.0	0.240	0.92		
Connection Schematic 	ELC10E151L	150.0	±10	10	0.260	0.83
	ELC10E181L	180.0			0.290	0.74
	ELC10E221L	220.0			0.410	0.64
	ELC10E271L	270.0			0.590	0.54
	ELC10E331L	330.0			0.660	0.52
	ELC10E391L	390.0			0.720	0.50
	ELC10E471L	470.0			0.800	0.45
	ELC10E561L	560.0			1.100	0.41
	ELC10E681L	680.0			1.200	0.37
	ELC10E821L	820.0			1.600	0.33
	ELC10E102L	1000.0			1.800	0.31
	ELC10E122L	1200.0			2.000	0.29
	ELC10E152L	1500.0			2.800	0.26
	ELC10E182L	1800.0			3.200	0.23
	ELC10E222L	2200.0			3.600	0.20
	ELC10E272L	2700.0			5.200	0.18
	ELC10E332L	3300.0			5.900	0.17
	ELC10E392L	3900.0			6.500	0.16
	ELC10E472L	4700.0			9.600	0.14
	ELC10E562L	5600.0			10.800	0.12
	ELC10E682L	6800.0			11.900	0.11
	ELC10E822L	8200.0			13.200	0.10

*Refer to former page

Examples Type 12E□□□L

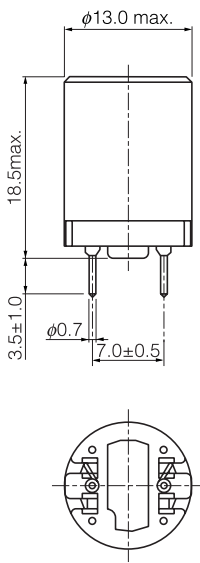
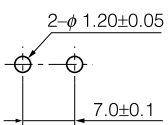
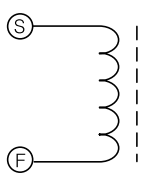
	Part No.	Inductance (μH)	Tolerance (%)	Test Freq. (kHz)	DCR.(Ω) [at 20°C] (Tol.±20 %)	*IDC. [at 20°C] (A)max.
<p>[Dimensions in mm] (not to scale)</p>  <p>Recommended PWB piercing plan</p>  <p>Connection Schematic</p> 	ELC12E4R7L	4.7	±25	10	0.014	4.40
	ELC12E5R6L	5.6			0.016	4.10
	ELC12E6R8L	6.8			0.018	3.90
	ELC12E8R2L	8.2	±20		0.020	3.70
	ELC12E100L	10.0			0.023	3.50
	ELC12E120L	12.0			0.024	3.30
	ELC12E150L	15.0			0.028	3.20
	ELC12E180L	18.0			0.030	3.10
	ELC12E220L	22.0			0.033	2.80
	ELC12E270L	27.0	±10		0.037	2.50
	ELC12E330L	33.0			0.041	2.40
	ELC12E390L	39.0			0.044	2.20
	ELC12E470L	47.0			0.048	2.00
	ELC12E560L	56.0			0.053	1.80
	ELC12E680L	68.0			0.073	1.70
	ELC12E820L	82.0			0.098	1.40
	ELC12E101L	100.0			0.140	1.30
	ELC12E121L	120.0			0.160	1.20
	ELC12E151L	150.0			0.180	1.10
	ELC12E181L	180.0			0.200	1.00
	ELC12E221L	220.0			0.220	0.91
	ELC12E271L	270.0	0.320		0.83	
	ELC12E331L	330.0	0.360		0.79	
	ELC12E391L	390.0	0.400		0.70	
	ELC12E471L	470.0	0.440		0.64	
	ELC12E561L	560.0	0.490		0.57	
	ELC12E681L	680.0	0.610		0.52	
	ELC12E821L	820.0	0.760		0.47	
	ELC12E102L	1000.0	1.100		0.43	
	ELC12E122L	1200.0	1.200		0.40	
	ELC12E152L	1500.0	1.400		0.36	
	ELC12E182L	1800.0	1.900		0.32	
	ELC12E222L	2200.0	2.500		0.30	
ELC12E272L	2700.0	3.500	0.26			
ELC12E332L	3300.0	3.900	0.24			
ELC12E392L	3900.0	4.300	0.22			
ELC12E472L	4700.0	6.000	0.20			
ELC12E562L	5600.0	6.600	0.17			
ELC12E682L	6800.0	9.900	0.15			
ELC12E822L	8200.0	10.900	0.14			
ELC12E103L	10000.0	12.200	0.13			

*Refer to former page

Examples Type 15E□□□L

[Dimensions in mm] (not to scale)	Part No.	Inductance (μ H)	Tolerance (%)	Test Freq. (kHz)	DCR.(Ω) [at 20°C] (Tol.±20 %)	*IDC. [at 20°C] (A)max.
<p>Recommended PWB piercing plan</p>	ELC15E100L	10	±20	10	0.018	5.40
	ELC15E180L	18			0.024	4.50
	ELC15E330L	33			0.032	4.00
	ELC15E560L	56	±10		0.039	3.60
	ELC15E101L	100			0.053	3.00
	ELC15E181L	180			0.100	2.30
	ELC15E331L	330			0.170	1.60
	ELC15E561L	560			0.280	1.20
	ELC15E102L	1000			0.490	0.95
	ELC15E182L	1800			0.870	0.75
	ELC15E332L	3300			1.600	0.53
	ELC15E562L	5600			2.600	0.39
	ELC15E103L	10000			4.600	0.30

*Allowable DC Current: Smaller current value either when the inductance of -10 % max. changed, or when the temperature of 45 k max. risen.

Examples Type 18E□□□L

[Dimensions in mm] (not to scale)	Part No.	Inductance (μ H)	Tolerance (%)	Test Freq. (kHz)	DCR.(Ω) [at 20°C] (Tol.±20 %)	*IDC. [at 20°C] (A)max.
<p>Recommended PWB piercing plan</p>	ELC18E100L	10	±20	10	0.014	5.90
	ELC18E180L	18			0.019	5.20
	ELC18E330L	33			0.026	4.60
	ELC18E560L	56	±10		0.031	3.80
	ELC18E101L	100			0.044	3.00
	ELC18E181L	180			0.067	2.50
	ELC18E331L	330			0.110	1.90
	ELC18E561L	560			0.170	1.40
	ELC18E102L	1000			0.280	1.00
	ELC18E182L	1800			0.570	0.80
	ELC18E332L	3300			1.000	0.60
	ELC18E562L	5600			1.600	0.46
	ELC18E103L	10000			2.700	0.33

*Allowable DC Current: Smaller current value either when the inductance of -10 % max. changed, or when the temperature of 45 k max. risen.

Tape Dimensions in mm for Type 09D (not to scale)

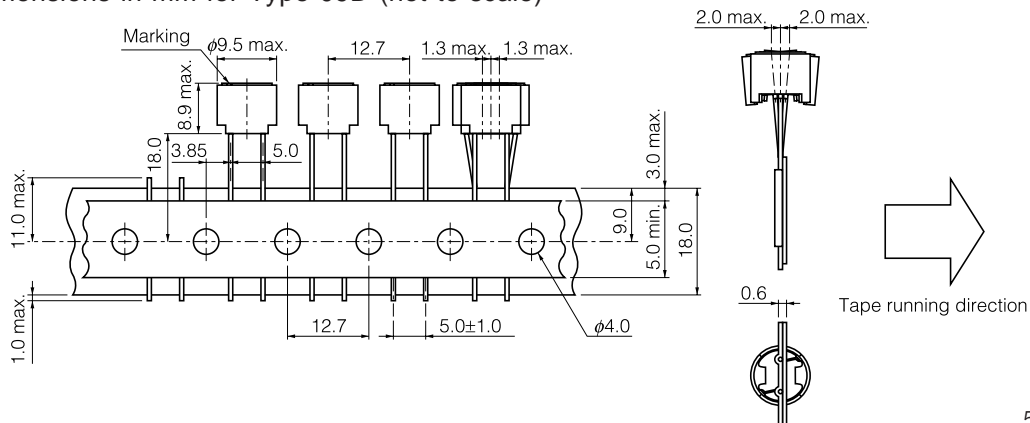

500 pcs./reel

Mouser Electronics

Authorized Distributor

Click to View Pricing, Inventory, Delivery & Lifecycle Information:

Panasonic:

[ELC-06D100E](#) [ELC-06D101E](#) [ELC-06D102E](#) [ELC-06D120E](#) [ELC-06D121E](#) [ELC-06D122E](#) [ELC-06D150E](#) [ELC-06D151E](#) [ELC-06D152E](#) [ELC-06D180E](#) [ELC-06D181E](#) [ELC-06D182E](#) [ELC-06D220E](#) [ELC-06D221E](#) [ELC-06D222E](#) [ELC-06D270E](#) [ELC-06D271E](#) [ELC-06D272E](#) [ELC-06D2R2E](#) [ELC-06D2R7E](#) [ELC-06D330E](#) [ELC-06D331E](#) [ELC-06D332E](#) [ELC-06D390E](#) [ELC-06D391E](#) [ELC-06D392E](#) [ELC-06D3R3E](#) [ELC-06D3R9E](#) [ELC-06D470E](#) [ELC-06D471E](#) [ELC-06D472E](#) [ELC-06D4R7E](#) [ELC-06D560E](#) [ELC-06D561E](#) [ELC-06D562E](#) [ELC-06D5R6E](#) [ELC-06D680E](#) [ELC-06D681E](#) [ELC-06D6R8E](#) [ELC-06D820E](#) [ELC-06D821E](#) [ELC-06D8R2E](#)