





NOTE [注記]

1. TAB PULLING STRENGTH OVER 29.4N
[端子溶接強度：29.4N以上]
2. TAB MATERIAL: STAINLESS STEEL WITH TIN PLATING 
[端子材料：基材 ステンレス/表面 部分Snメッキ 
3. () : REFERENCE DIMENSION AND ANGLE
[() 寸法、角度は参考値]

PRODUCT NO.	BR-2/3AE2PN	SCALE	
		2:1	
DRAWING NO.	PC-B23A0441	REV.	
		0	

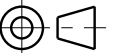
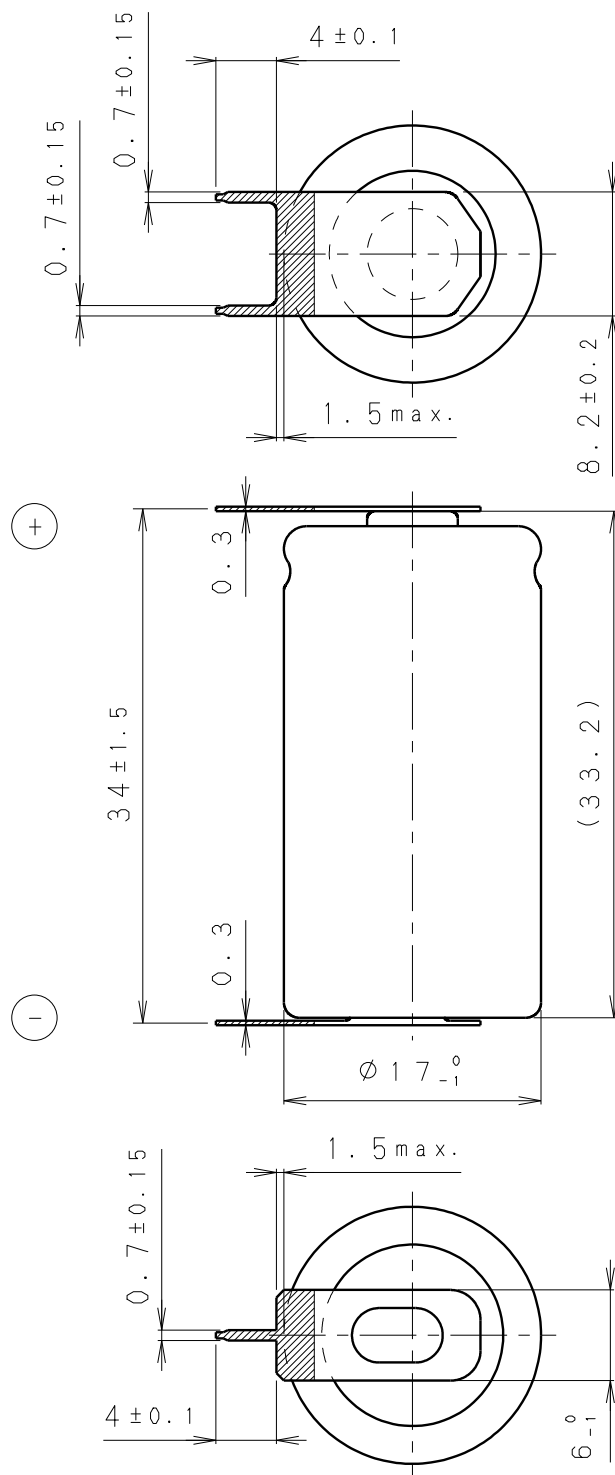

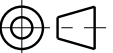

* Note [注記]

1. Tab pulling Strength Over 30N
[端子溶接強度: 30N以上]
2. Tab Material: Stainless Steel with Tin plating 
[端子材料: 基材 ステンレス/表面 部分Snメッキ 
3. (): Reference dimension and angle
[() 寸法、角度は参考値]

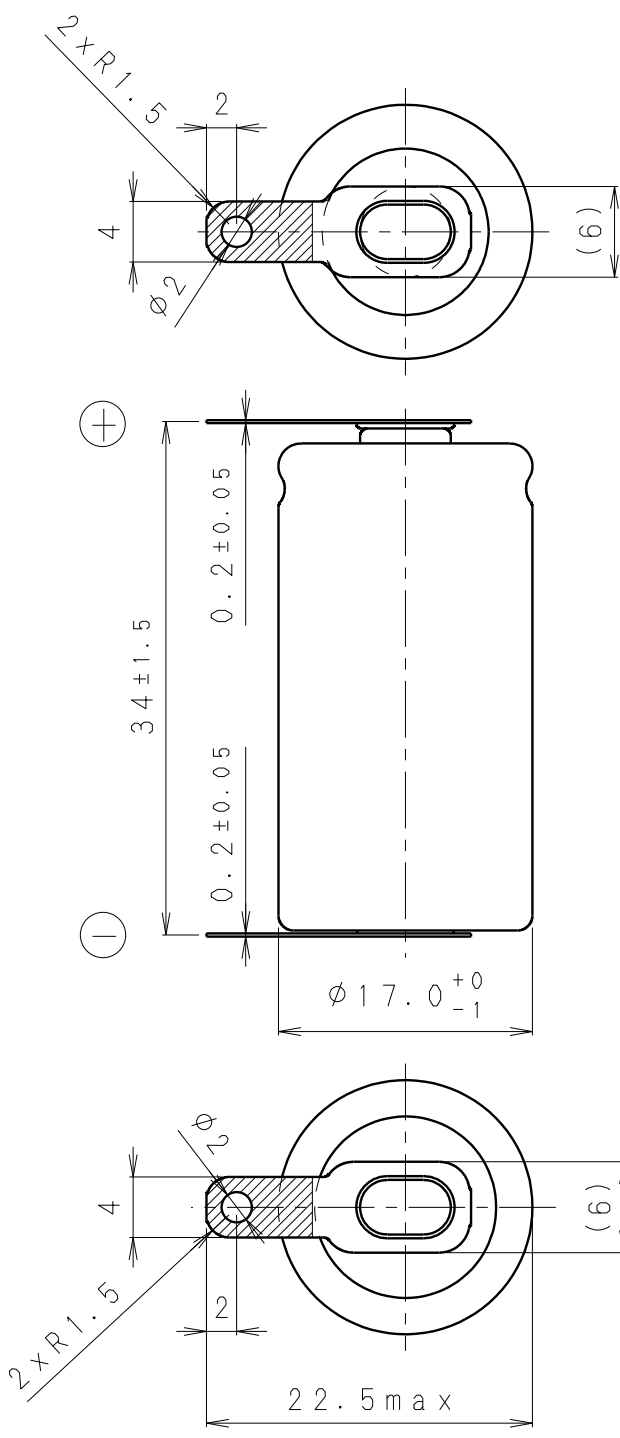
Product No.	CR-2/3AZE2PN	Scale	
		2:1	
Drawing No.	PC-C23AZ0434	Rev.	
		0	



* Note [注記]

1. Tab pulling Strength Over 9.8N
[端子溶接強度：9.8N以上]
2. Tab Material: Stainless Steel with Tin plating 
[端子材料：基材 ステンレス/表面 部分Snメッキ 
3. (): Reference dimension and angle
[() 寸法、角度は参考値]

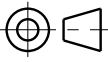
Product No.	CR-2/3AZT5PN	Scale	
		2:1	
Drawing No.	PC-C23AZ0447	Rev.	
		1	

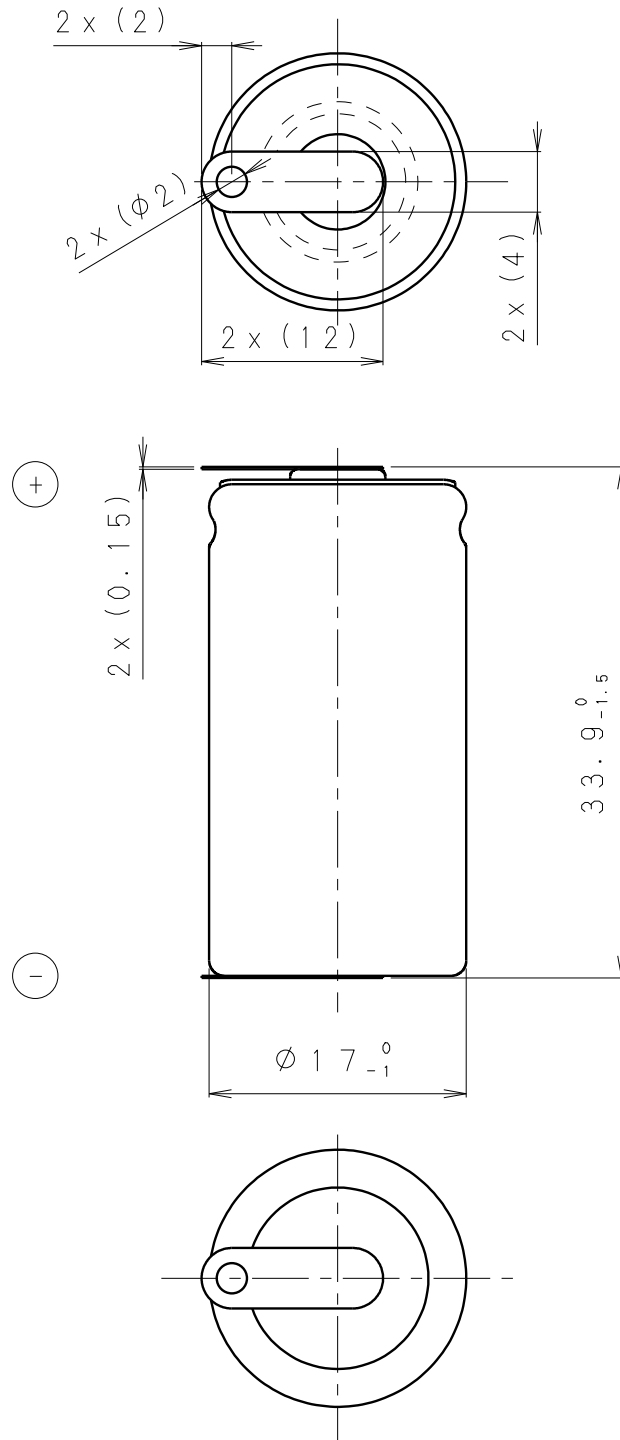

* Note [注記]

1. Tab pulling Strength Over 9.8N
[端子溶接強度: 9.8N以上]
2. Tab Material: Nickel or Nickel plating steel
[端子材料: 基材 ニッケルもしくはニッケルメッキ鋼板]
3. (): Reference dimension and angle
[() 寸法、角度は参考値]

PRODUCT NO.	BR-2/3AT2SPN	SCALE	
		2:1	
DRAWING NO.	PC-B23A0104	REV.	 UNIT: mm
		0	

Mouser Electronics

Authorized Distributor

Click to View Pricing, Inventory, Delivery & Lifecycle Information:

[Panasonic:](#)

[BR-2/3AT2SPN](#)