



## FEATURES

### 1. High sensitivity

A nominal operating power of 250mW and high sensitivity make it ideal for energy saving (LK relay is 530mW).

### 2. Silent

Approx. 10 dB less sound pressure than previous LK series relay

### 3. High inrush current capability

Switching capability;

- TV-5 type: inrush 100A, steady: 5A

- TV-8 type: inrush 118A, steady: 8A

### 4. High insulation resistance

1) Creepage distance and clearances between contact and coil: Min. 6 mm .236 inch (In compliance with IEC60065)

2) Surge withstand voltage between contact and coil: 10,000 V

### 5. Conforms to the various safety standards

UL/C-UL, TÜV, and SEMKO approved

## TYPICAL APPLICATIONS

- Flat-panel TVs
- Audio visual equipment

## ORDERING INFORMATION

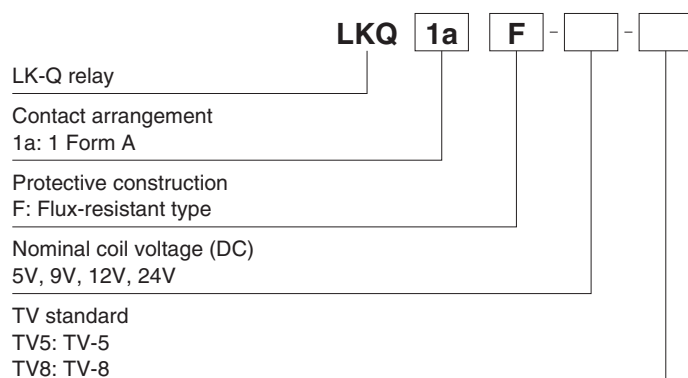

Note: Certified by UL/C-UL, TÜV and SEMKO

## TYPES

Contact arrangement	Nominal coil voltage	Part No.	
		TV-5 type	TV-8 type
1 Form A	5V DC	LKQ1aF-5V-TV5	LKQ1aF-5V-TV8
	9V DC	LKQ1aF-9V-TV5	LKQ1aF-9V-TV8
	12V DC	LKQ1aF-12V-TV5	LKQ1aF-12V-TV8
	24V DC	LKQ1aF-24V-TV5	LKQ1aF-24V-TV8

Standard packing Carton: 100 pcs. Case: 500 pcs.

## RATING

### 1. Coil data

Nominal coil voltage	Pick-up voltage (at 20°C 68°F)	Drop-out voltage (at 20°C 68°F)	Nominal operating current [±10%] (at 20°C 68°F)	Coil resistance [±10%] (at 20°C 68°F)	Nominal operating power	Max. applied voltage (at 20°C 68°F)
5V DC	80%V or less of nominal voltage (Initial)	10%V or more of nominal voltage (Initial)	50mA	100Ω	250mW	6.5V DC
9V DC			27.8mA	324Ω		11.7V DC
12V DC			20.8mA	576Ω		15.6V DC
24V DC			10.4mA	2,304Ω		31.2V DC

## 2. Specifications

Characteristics	Item	Specifications		
		TV-5 type	TV-8 type	
Contact	Arrangement	1 Form A		
	Contact resistance (Initial)	Max. 100 mΩ (By voltage drop 6 V DC 1A)		
	Contact material	AgSnO <sub>2</sub> type		
Rating	Nominal switching capacity (resistive load)	5A 277V AC	8A 277V AC	
	Max. switching power (resistive load)	1,385VA	2,216VA	
	Max. switching voltage	277V AC		
	Max. switching current	5A (AC)	8A (AC)	
	Min. switching capacity (reference value)*1	100mA, 5V DC		
Electrical characteristics	Insulation resistance (Initial)	Min. 1,000MΩ (at 500V DC) Measurement at same location as "Breakdown voltage" section.		
	Breakdown voltage (Initial)	Between open contacts	1,000 Vrms for 1 min. (Detection current: 10 mA)	
		Between contact and coil	4,000 Vrms for 1 min. (Detection current: 10 mA)	
	Temperature rise (coil)	Max. 35°C 95°F (with nominal coil voltage and at 5A contact carrying current, at 70°C 158°F)	Max. 35°C 95°F (with nominal coil voltage and at 8A contact carrying current, at 70°C 158°F)	
	Surge breakdown voltage*2 (Between contact and coil) (Initial)	10,000 V		
	Operate time (at nominal voltage) (at 20°C 68°F) (Initial)	Max. 15 ms (excluding contact bounce time.)		
	Release time (at nominal voltage) (at 20°C 68°F) (Initial)	Max. 5 ms (excluding contact bounce time) (Without diode)		
Mechanical characteristics	Shock resistance	Functional	200 m/s <sup>2</sup> (Half-wave pulse of sine wave: 11 ms; detection time: 10μs.)	
		Destructive	1,000 m/s <sup>2</sup> (Half-wave pulse of sine wave: 6 ms.)	
	Vibration resistance	Functional	10 to 55 Hz at double amplitude of 1.5 mm (Detection time: 10μs.)	
		Destructive	10 to 55 Hz at double amplitude of 1.5 mm	
Expected life	Mechanical (at 180 times/min.)	Min. 10 <sup>6</sup>		
	Electrical	Min. 10 <sup>5</sup> (ON: 1.5s, OFF: 1.5s, at nominal switching capacity)	Min. 5×10 <sup>4</sup> (ON: 1.5s, OFF: 1.5s, at nominal switching capacity)	
Conditions	Conditions for operation, transport and storage*3	Ambient temperature: -40°C to +70°C -40°F to +158°F, Humidity: 5 to 85% R.H. (Not freezing and condensing at low temperature), Air pressure: 86 to 106kPa		
	Max. operating speed	20 times/min. (at nominal switching capacity)		
Unit weight		Approx. 12 g .42 oz		

**Notes:**

- \*1. This value can change due to the switching frequency, environmental conditions, and desired reliability level, therefore it is recommended to check this with the actual load.
- \*2. Wave is standard shock voltage of ±1.2×50μs according to JEC-212-1981
- \*3. The upper limit of the ambient temperature is the maximum temperature that can satisfy the coil temperature rise value. Refer to "6. Usage, Storage and Transport Conditions" in [AMBIENT ENVIRONMENT section in Relay Technical Information](#).

## REFERENCE DATA

### 1. Max. switching power (AC resistive load)

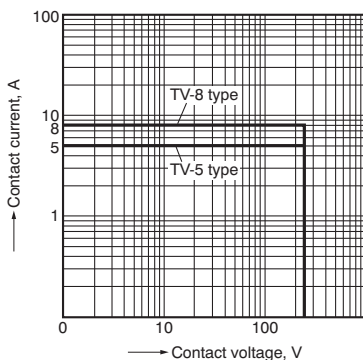

### 2-(1). Coil temperature rise (TV-5 type)

Sample: LKQ1aF-12V-TV5, 6 pcs.  
Point measured: coil inside  
Contact current: 0A, 5A

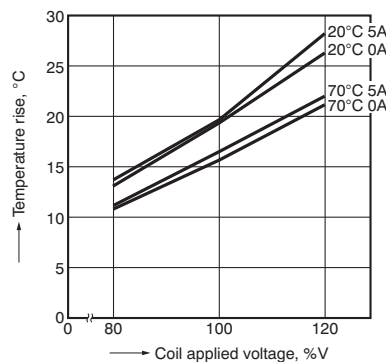

### 2-(2). Coil temperature rise (TV-8 type)

Sample: LKQ1aF-12V-TV8, 6 pcs.  
Point measured: coil inside  
Contact current: 0A, 8A

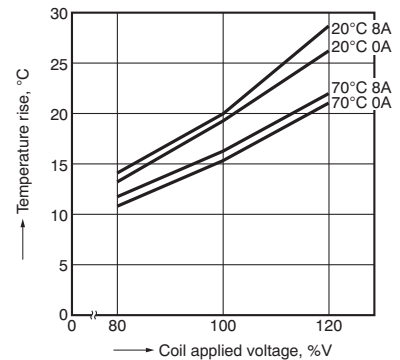

3-(1). Ambient temperature characteristics and coil applied voltage (TV-5 type)

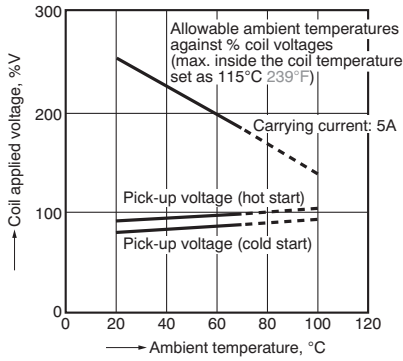

3-(2). Ambient temperature characteristics and coil applied voltage (TV-8 type)

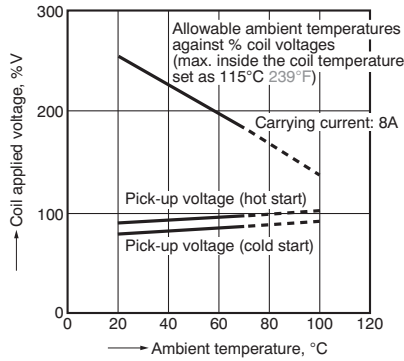

4-(1). Electrical life test (TV-5 type)

(5A 277V AC, resistive load)  
 Sample: LKQ1aF-12V-TV5, 6 pcs.  
 Operation frequency: 20 times/min.  
 (ON/OFF = 1.5s: 1.5s)  
 Ambient temperature: 20°C 68°F

Circuit:

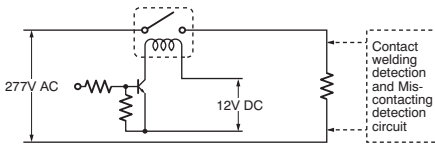

Change of pick-up and drop-out voltage

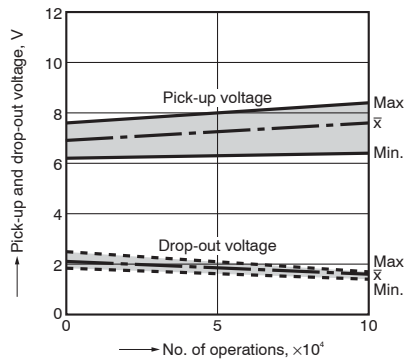

Change of contact resistance

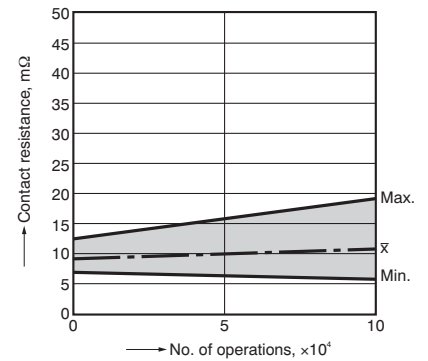

4-(2). Electrical life test (TV-8 type)

(8A 277V AC, resistive load)  
 Sample: LKQ1aF-12V-TV8, 6 pcs.  
 Operation frequency: 20 times/min.  
 (ON/OFF = 1.5s: 1.5s)  
 Ambient temperature: 20°C 68°F

Circuit:

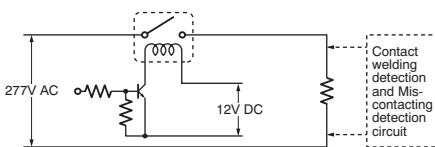

Change of pick-up and drop-out voltage

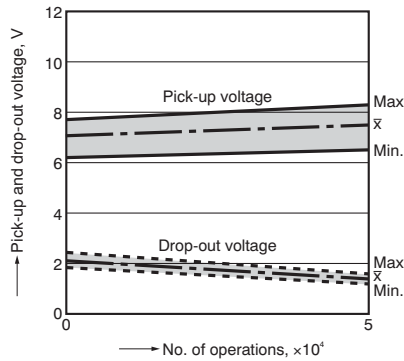

Change of contact resistance

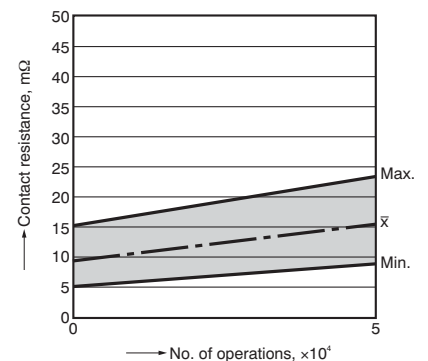

5-(1). Operation noise distribution

Measuring conditions  
 Sample: LKQ1aF-12V-TV5, 50pcs  
 Background noise: approx. 20dB  
 Coil voltage: 12V DC  
 Equipment setting: "A" weighted  
 Single part (refer to figure below)  
 With diode

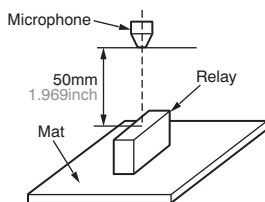

When operate (At contact making)

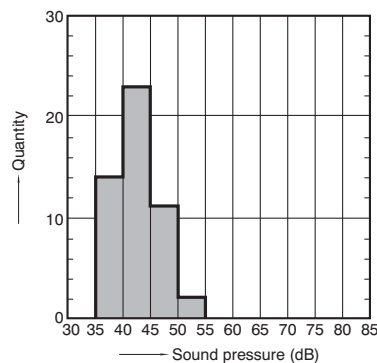

When release (At contact breaking)

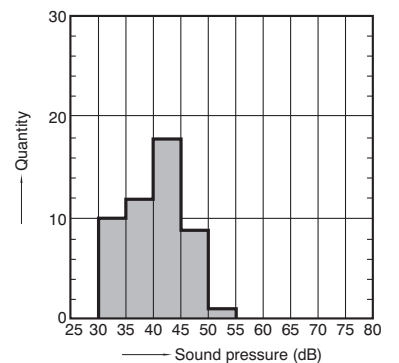

# LK-Q

## 5-(2). Operation noise distribution (refer to comparison)

Measuring conditions  
 Sample: LKS1aF-12V, 50pcs  
 Background noise: approx. 20dB  
 Coil voltage: 12V DC  
 Equipment setting: "A" weighted  
 Single part (refer to figure below)  
 With diode

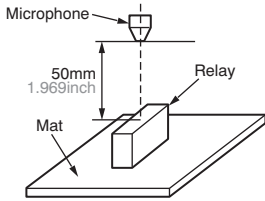

When operate

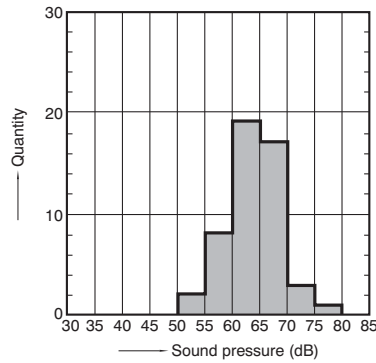

When release

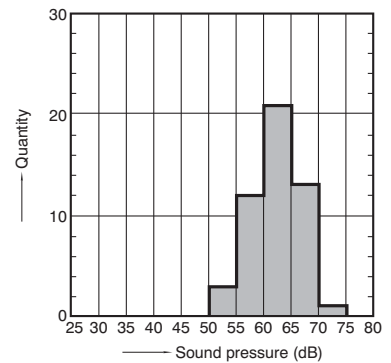

## DIMENSIONS (mm inch)

Download [CAD Data](#) from our Web site.

[CAD Data](#)



External dimensions

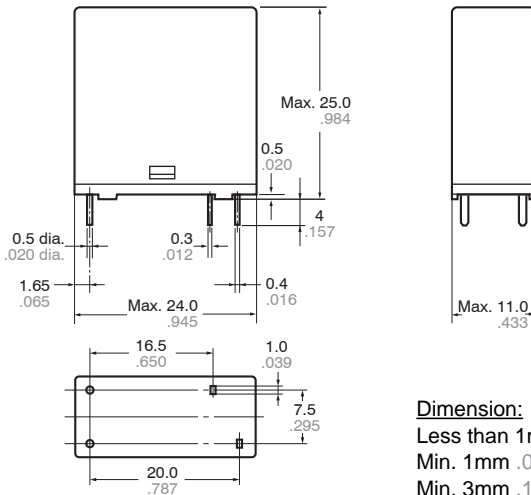

PC board pattern (Bottom view)

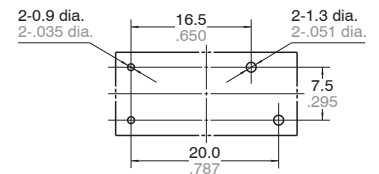

Tolerance:  $\pm 0.1 \pm 0.004$

Schematic (Bottom view)

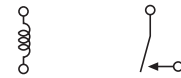

**Dimension:**

Less than 1mm .039inch:

Min. 1mm .039inch less than 3mm .118 inch:

Min. 3mm .118 inch:

**General tolerance**

$\pm 0.1 \pm 0.004$

$\pm 0.2 \pm 0.008$

$\pm 0.3 \pm 0.012$

## SAFETY STANDARDS

UL/C-UL (Recognized)		TV rating (UL/C-UL)		TÜV (Certified)		SEMKO (Certified)	
File No.	Contact rating	File No.	Rating	File No.	Rating	File No.	Contact rating
E43149	5A 277V AC, 5A 30V DC 10A 277V AC	UL/C-UL E43149	TV-5	B 11 03 13461 284	5A 250V AC (cosφ=1.0)	807779	5A 250V AC
E43149	5A 277V AC, 5A 30V DC 8A 277V AC, 10A 277V AC	UL/C-UL E43149	TV-8		8A 250V AC (cosφ=1.0)		3/100A 250V AC

\* CSA standard: Certified by C-UL

For Cautions for Use, see [Relay Technical Information](#).

# Mouser Electronics

Authorized Distributor

Click to View Pricing, Inventory, Delivery & Lifecycle Information:

## Panasonic:

[LKQ1AF-12V-TV-5](#) [LKQ1AF-12V-TV-8](#) [LKQ1AF-12V-TV8-Y2](#) [LKQ1AF-24V-TV-5](#) [LKQ1AF-24V-TV-8](#) [LKQ1AF-5V-TV-5](#) [LKQ1AF-5V-TV-8](#) [LKQ1AF-9V-TV-5](#) [LKQ1AF-9V-TV-8](#) [LKQ1AF-5V-TV8-Y2](#) [LKQ1AF-9V-TV8](#) [LKQ1AF-12V-TV8](#) [LKQ1AF-24V-TV5](#) [LKQ1AF-24V-TV8](#) [LKQ1AF-5V-TV5](#) [LKQ1AF-5V-TV8](#) [LKQ1AF-12V-TV5](#)