

Features & Benefits

- A small and slim pin-shaped Lithium Ion battery which expands design options for micro devices.
- A high-strength metal exterior case provides excellent reliability.
- Rapid charging makes your portable devices more user-friendly.

Part number	CG-320B	
Maximum charging voltage	4.35V	
Nominal Voltage	3.8V	
Typical Capacity	16.0mAh	
Rated Capacity	15.0mAh	
Dimensions*	Diameter(Max.)	3.65mm
	Height(Max.)	20.0mm
Weight*	Approx. 0.5g	
Operating Temperature	Charge	0°C to +60°C
	Discharge	-20°C to +60°C
Maximum continuous discharging current	20.0mA	
Maximum charging current	11.2mA(0.75It)	
Certifications	IEC62133, UL1642	

Terminal Types

Li Ion Pin cells are only available With Solderable Tabs

CG-320B/M3 Surface Mount Type	
CG-320B/E3 Through Hole Type	

* All models have stainless steel tab with tin (Sn) plating. * Without tabs.

Applications



As of March, 2020. The contents of this product information are subject to change without notice.

Battery Characteristics

Charge and Discharge Characteristics

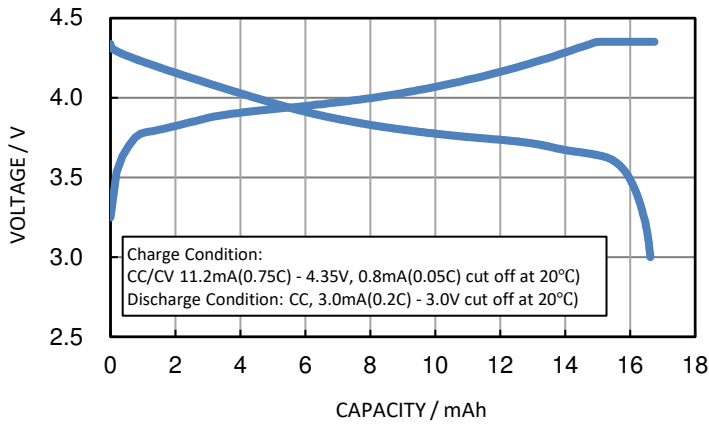

Cycle Life Characteristics

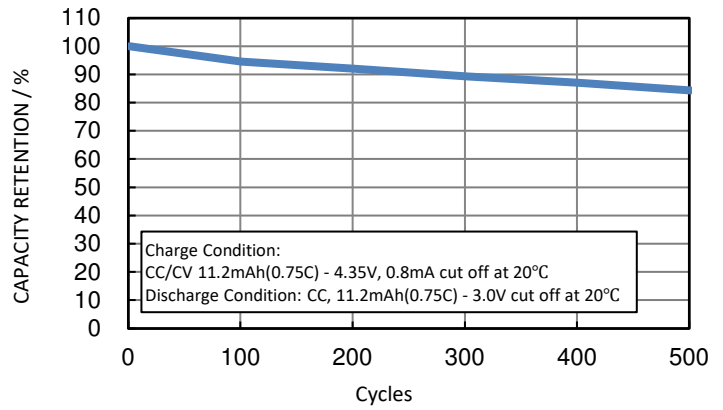

Discharge Characteristics by Temperature

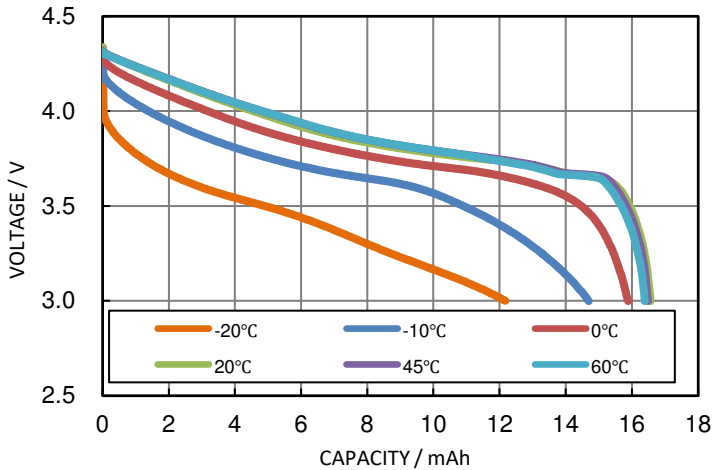

Discharge Characteristics by Rate of Discharge

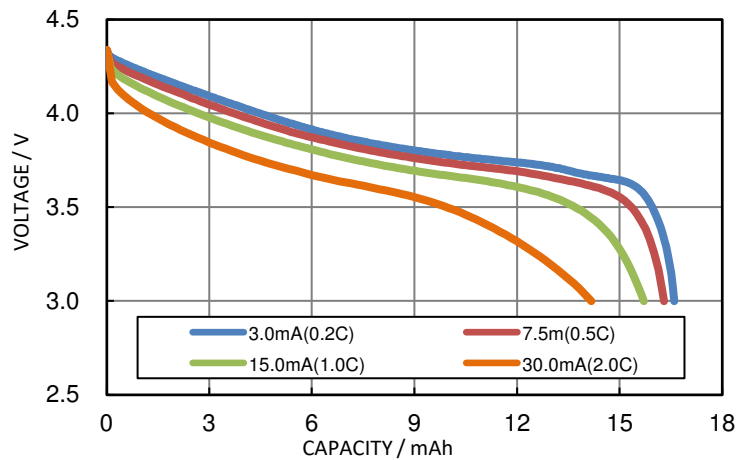

Pulse Discharging Characteristics

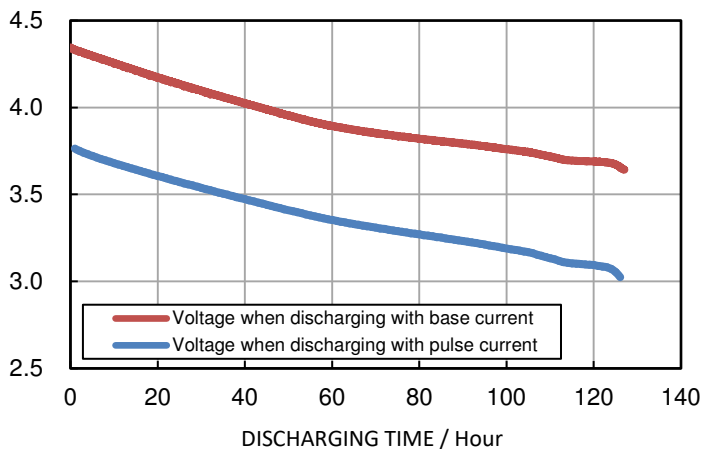

Charge Condition : CC/CV 11.25mA(0.75C) - 4.35V, 0.3mA(0.02C) cut-off at 20°C
 Discharge Condition : Pulse current 150mA(10C) for 0.5s in every hour, Base current 0.1mA, 3.0V cut-off at 20°C

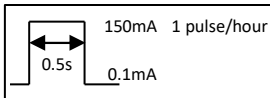

This data in this document is for descriptive purposes only and is not intended to make or imply any guarantee or warranty.

Handling Guidelines

1. Standard Voltage Range is 3.0 - 4.35V. Protection required for over-charge/over-discharge.

Standard Voltage Range	3.0~4.35V
Do not over-charge	Stop charging at $4.45 \pm 0.05V$
	Allow charging again at less than $4.25 \pm 0.05V$
Do not over-discharge	Stop discharge at $2.7 \pm 0.1V$
	Allow discharging again at more than $3.3 \pm 0.1V$
Over Current Protection	Stop discharge in the case of an out-put connection short circuit.

2. In order to prevent accidental ingestion of the battery, it must be inaccessible to the individual user / customer.

The battery will be shipped with tabs. Please attach the battery to the device.

March 2020 - The contents of this datasheet are subject to change without notice.

<https://industrial.panasonic.com/ww/products/batteries/secondary-batteries/pin-li-ion>
oembatteries@us.panasonic.com (877) 726-2228

SYMBOL	DATE	REVISION	SIGNED	CHECKED
△				

MATERIAL LIST

ITEM	CONTENTS
①	BATTERY [素電池] CG-320B
②	TAB (+/-Common) SUS430-BA

NOTE [注記]

- TAB MATERIAL: STAINLESS STEEL WITH TIN PLATING [端子材料: 基材 ステンレス/表面 部分Snメッキ]
- Measurement Point (*)
- (): REFERENCE DIMENSION AND ANGLE [() 寸法、角度は参考値]
- PLEASE PAY CLOSE ATTENTION TO FOLLOWINGS SO THAT YOU AVOID THE POSSIBLE EXTERNAL SHORT-CIRCUIT BETWEEN THE POSITIVE TABBING AND NEGATIVE CASE DUE TO THE CLOSE DISTANCE BETWEEN THEM [正極側の異極間距離が非常に短いため、以下の内容について短絡防止の配慮をお願いします]
 (1) THE DESIGN OF THE CIRCUIT BOARD PATTERN [基板パターン設計]
 (2) THE METHOD OF SECURING THE BATTERY ON THE BOARD [電池と基板の固定方法]
 (3) THE PROCESS OF MOUNTING THE BATTERY ON THE BOARD [電池の取付工程]
- PULL STRENGTH: OVER 12.2N [引張強度: 12.2N以上]

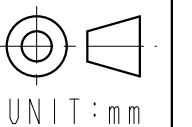
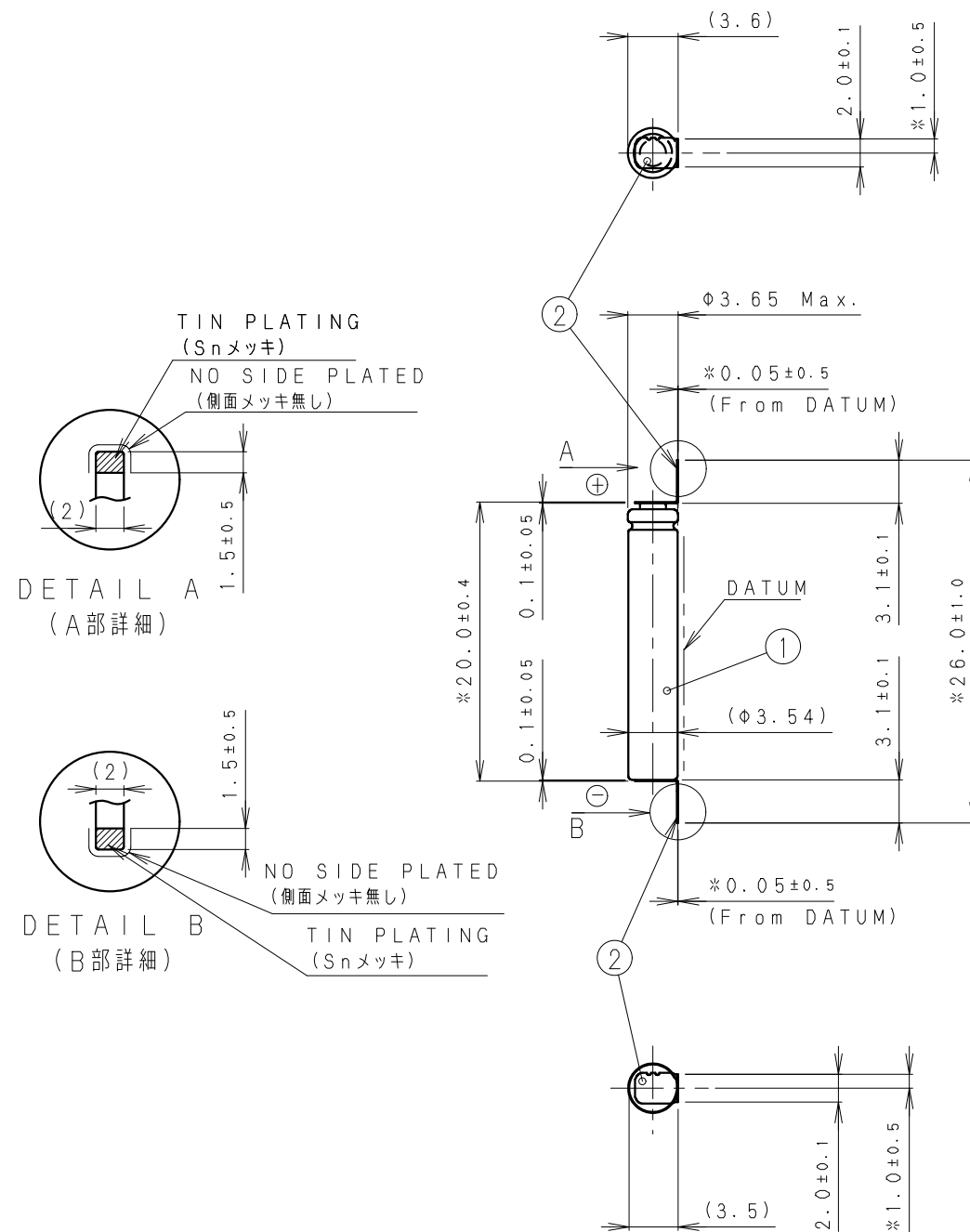

UNLESS OTHERWISE SPECIFIED DIMENSIONS ARE IN TOLERANCES ON 'STANDARD TOLERANCE'	NOMINAL SIZE		STANDARD TOLERANCE		PRODUCT NO.	NAME	
	≦ 6		± 0.5				CG-320B/M3
	6 < ~ ≦ 30		± 1.0				
	30 < ~ ≦ 120		± 2.0				
NOMINAL ANGLE		± 5°		DRAWING NO.	REV.		
SCALE	DESIGNED	DRAWN	CHECKED			CHECKED	APPROVED
2:1	若林 Feb. 24, 2021	若林 Feb. 24, 2021	石丸	山本	山下藤	PD-CG-320B/M3	0

SYMBOL	DATE	REVISION	SIGNED	CHECKED
△				

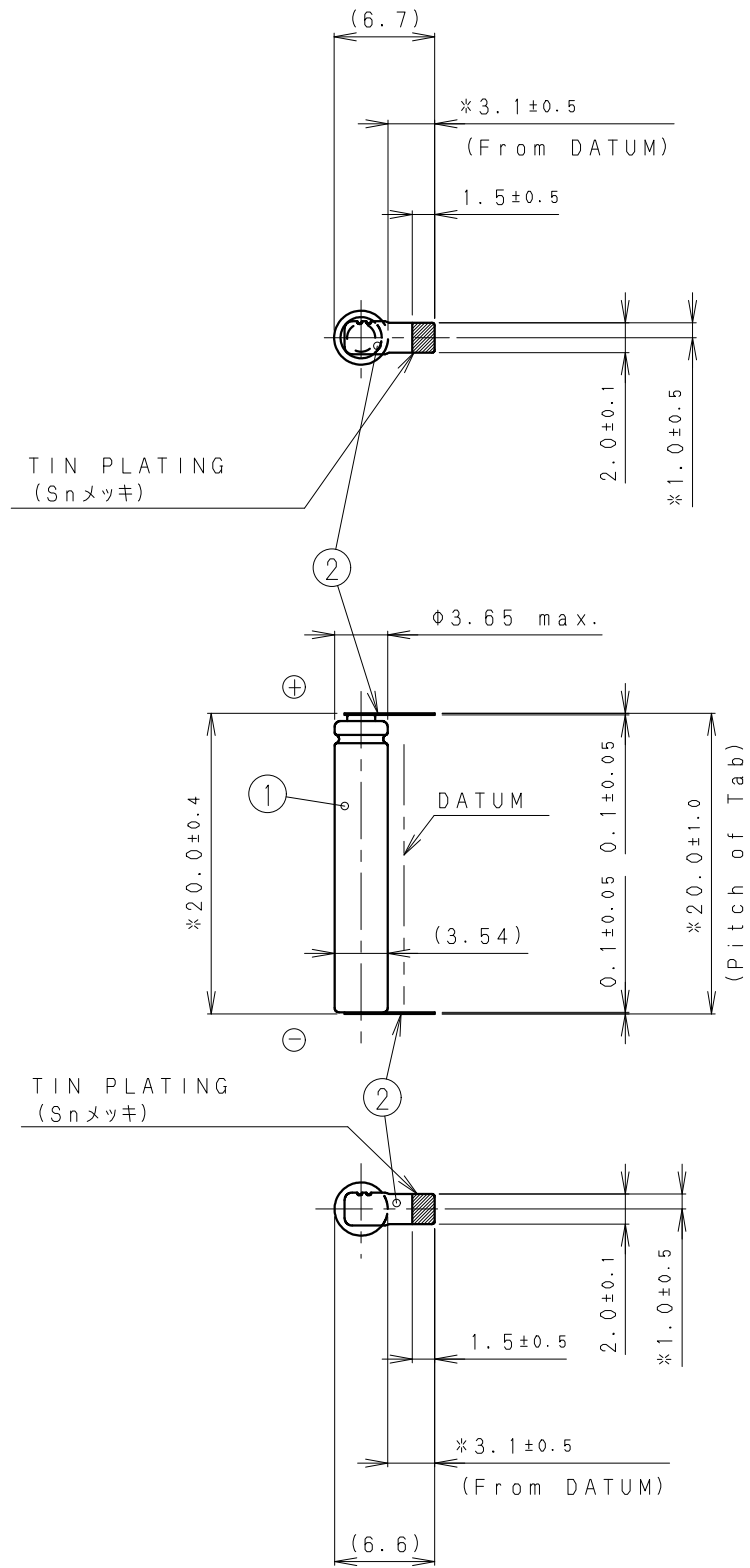

MATERIAL LIST

ITEM	CONTENTS
①	BATTERY [素電池] CG-320B
②	TAB (+/-Common) SUS430-BA

NOTE [注記]

- TAB MATERIAL: STAINLESS STEEL WITH TIN PLATING [端子材料: 基材 ステンレス/表面 部分Snメッキ]
- Measurement Point (*)
- (): REFERENCE DIMENSION AND ANGLE [() 寸法、角度は参考値]
- PLEASE PAY CLOSE ATTENTION TO FOLLOWINGS SO THAT YOU AVOID THE POSSIBLE EXTERNAL SHORT-CIRCUIT BETWEEN THE POSITIVE TABBING AND NEGATIVE CASE DUE TO THE CLOSE DISTANCE BETWEEN THEM [正極側の異極間距離が非常に短いため、以下の内容について短絡防止の配慮をお願いします]
 (1) THE DESIGN OF THE CIRCUIT BOARD PATTERN [基板パターン設計]
 (2) THE METHOD OF SECURING THE BATTERY ON THE BOARD [電池と基板の固定方法]
 (3) THE PROCESS OF MOUNTING THE BATTERY ON THE BOARD [電池の取付工程]
- PULL STRENGTH: OVER 12.2N [引張強度: 12.2N以上]

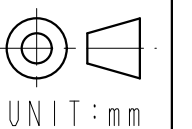

UNLESS OTHERWISE SPECIFIED DIMENSIONS ARE IN TOLERANCES ON 'STANDARD TOLERANCE'	NOMINAL SIZE		STANDARD TOLERANCE		PRODUCT NO.	CG-320B/E3
	≦ 6		± 0.5			
	6 < ~ ≦ 30		± 1.0			
	30 < ~ ≦ 120		± 2.0			
NOMINAL ANGLE		± 5°		DRAWING NO.	PD-CG-320B/E3	REV.
SCALE	DESIGNED	DRAWN	CHECKED			CHECKED

CG320B Li Ion Pin Cell - Charging Instructions	
Charge Temperature	Battery should be charged between 0°C and 60°C.
Charge Voltage between 10°C and 45°C	At ambient temperatures less than 45°C, the charge voltage should be 4.35V maximum.
Charge Current between 10°C and 45°C	At 10°C and higher, the maximum charge current should be 11.2mA(0.75It).
Charging at less than 10°C	Battery should be charged at 6.0mA(0.4It) maximum at 10°C and lower.
Charging between 45°C and 60°C	Charge setting voltage should be maximum 4.25V if the temperature is between 45°C and 60°C.
Charging Low Voltage Battery	<p>If the open circuit voltage is less than 3.0V, the battery should be charged at 1.5mA(0.1It) or less until the voltage reaches 3.0V. If the voltage is less than 2.7V, the battery may experience significant reduction in performance.</p> <p>If the battery voltage remains less than 3.0V after 1 hour, stop charging.</p> <p>If the battery voltage drops to less than 0.5V, terminate charging. The battery may catch on fire, smoke, explode, or cause heat generation.</p>
Charge End	The battery should be fully charged when the current reaches 0.8 mA. The charging process should not be continued below 0.5 mA charging current.
Charge Timer	A timer should be used in all charging profiles. Standard total charge time is 3 hours at specified charge rates.
Charger Control	Charger should have overvoltage protection to prevent charge voltage exceeding 5V even in the case of charger malfunction.
Pulse Charging	Pulse charging is prohibited.

CG320B Li Ion Pin Cell – Battery Protection

<p>Safety Unit</p>	<p>The Li Ion Pin cell does NOT have a safety unit for battery protection. The Li Ion Pin cell should be used with a safety unit.</p>
<p>Overcharge Protection</p>	<p>When the battery voltage exceeds $4.45 \pm 0.05V$, charging should be stopped. Once the battery voltage is less than $4.25 \pm 0.05V$, charging can resume.</p>
<p>Overdischarge Protection</p>	<p>When battery voltage is less than $2.7 \pm 0.1V$, discharging should be stopped. Once battery voltage exceeds $3.3 \pm 0.1V$, discharging should be restarted.</p>
<p>Overcurrent Protection</p>	<p>When output terminals are short circuited, discharge should be halted.</p>

CG320B Li Ion Pin Cell – Precautions for use	
Storage Precautions	<p>Store the battery at a constant temperature of 5°C to 35°C in order to prevent deterioration from heat.</p> <p>Storage at less than -20°C may cause a leakage.</p> <p>Keep the battery away from high humidity such as 85% RH or higher in order to prevent self-discharge caused by corrosion.</p> <p>Keep the battery away from heat sources i.e., boiler, radiator and etc., and from direct sunlight.</p> <p>Please be careful not to generate dew condensation due to sudden change of storage temperature.</p> <p>In the case of long-term storage such as over 1 month, please store the battery in a cool, dry place approximately 20°C.</p>
Operation Temperature	<p>Refer to the operating temperature range on page 1 on the datasheet.</p> <p>Extended operation or storage at the high end of the temperature range may reduce battery life.</p>
Soldering	<p>Do not solder anything directly to the battery.</p> <p>Battery with tab</p> <p>When soldering a battery with tab, make sure that soldering iron does not touch the battery directly.</p> <p>Soldering shall be done within 5sec with iron front temperature at about 350°C, and the battery surface temperature shall not exceed 85°C. Internal components of the battery, including the separator and gasket, are made with resin and can be damaged by high temperature causing possible leakage.</p> <p>Avoid dust, foreign matter and heat generating components.</p> <p>Please pay close attention to avoid possible external short-circuit between the positive tabbing and the negative case due to the close proximity between them.</p> <p>(1)the design of the circuit board pattern (2)the method of securing the battery onto the board (3)the process of mounting the battery to the board</p>
Series and Parallel Connections	<p>Please contact Panasonic regarding series and parallel connections.</p>
Mounting	<p>The battery must be inaccessible to the individual user / customer.</p>

CG320B Li Ion Pin Cell – Precautions for use

<p>Used Battery</p>	<p>Please dispose according to regional rules, laws and regulations.</p>
<p>Prohibitions</p>	<p>Please observe the following: If NOT observed, the battery may catch on fire, smoke, explode, or cause heat generation.</p> <ul style="list-style-type: none"> *Never use other than in the applied voltage range(3.0~4.35V). *Never disassemble the battery. *Never deform the battery. *Never give a strong shock to the battery and never throw it. *Pack the battery securely for transport. *Never throw the battery into fire or water. *Never expose to heat or flame. *Never expose the battery to conditions higher than 85°C. *Use authorized chargers or observe charging conditions specified in this document for battery charging. *Never connect the battery to an AC outlet or DC automotive plug. *Stop charging if the charging process cannot be finished. *Never short-circuit. Especially as positive and negative electrode are in proximity to each other. *Never reverse the polarity (+) and (-). *Never use different types of batteries together. Avoid using this battery and dry-cell battery, coin-type lithium battery, old and new batteries, any other combination of rechargeable batteries. *Never pack multiple batteries in a bag avoid short circuit. *Never forcibly discharge. *Keep out of the hands of children. There is a possibility of accidental ingestion. *Never place the battery in or near a microwave or other cooking appliances. *Immediately stop using the battery if there are any noticeable abnormalities, such as leak, smell, heat, discoloration, or deformity. *If liquid leaking from the battery gets into your eyes, immediately flush your eyes with clean water and seek medical attention. If left untreated, it will cause significant eye damage.

Li Ion Pin Cell – Disclaimer

- 1) You shall not alter, change, repair, improve or modify our battery (“Battery”). Panasonic Corporation (“Panasonic”) shall not be responsible for any issues caused by modifications to the Battery taken place after that the Battery is delivered to the customer.
- 2) Panasonic shall not warrant or be responsible in any case where you fail to carry out proper handling, operating, installation, testing, service and checkout of the Battery and/or to follow the instruction, cautions, warnings, and notes provided in this data sheet.
- 3) In no event shall Panasonic be responsible for any defects of the Battery or any performance of any devices in which the Battery are incorporated.
- 4) Panasonic makes no representation or warranties, express or implied, with respect to the Battery, including, but not limited to, the implied warranties of merchantability and of fitness for a particular purpose.
- 5) Panasonic shall not take any responsibility for the use or incorporation of the Battery for or into devices for which failure or malfunction of the Battery may directly jeopardize life or cause threat of personal injury, such as for medical equipment, vehicle equipment, aircraft and aerospace equipment, aircraft electronics equipment, explosion-proof equipment or any other similar equipment.
- 6) IN NO EVENT SHALL PANASONIC, REGARDLESS OF THE LEGAL REASON, TORT OR OTHERWISE, BE LIABLE TO YOU AND/OR ANY THIRD PARTIES FOR ANY LOST PROFITS OR FOR SPECIAL, DIRECT, INDIRECT, INCIDENTAL OR CONSEQUENTIAL DAMAGES, INCLUDING, WITHOUT LIMITATION, ANY LOSS, DAMAGES, COSTS AND EXPENSES ARISING FROM OR IN CONNECTION WITH THE USE OF THE BATTERY AND/OR ANY LOSS OF ELECTRICAL POWER, COMMUNICATION AND DATA.
- 7) You shall, to the extent available under applicable law, defend, indemnify and hold Panasonic, its affiliates, customers, and its and their respective officers, directors, agents, servants, representatives and employees (collectively, “Panasonic Parties”) harmless from and against all losses, liabilities, damages, claims, demands, actions, proceedings, lawsuits, judgments, governmental orders, recalls, proposed recalls and all costs and expenses, including but not limited to reasonable attorneys’ fees and other professionals’ fees and expenses incurred in the investigation or defense thereof or the enforcement of rights hereunder, in each case whether or not resulting from third party claims (collectively, “Claims”), arising out of or in connection with the Battery. For the avoidance of doubt, you shall defend, indemnify and hold the Panasonic Parties harmless from and against any and all Claims arising out of or in connection with (i) death or injury to any person, or damage to any property, resulting, directly or indirectly, from the design, manufacture, assembly, purchase, sale, use, operation or disposal of the Battery, (ii) any loss of an electrical power, communication or data due to the Battery regardless of the cause thereof, or (iii) your failure to comply with the terms and conditions set forth in this disclaimer.
- 8) This disclaimer may be subject to change without notice.

March 2020 - The contents of this datasheet are subject to change without notice.

<https://industrial.panasonic.com/ww/products/batteries/secondary-batteries/pin-li-ion>
oembatteries@us.panasonic.com (877) 726-2228

Mouser Electronics

Authorized Distributor

Click to View Pricing, Inventory, Delivery & Lifecycle Information:

[Panasonic:](#)

[CG-320B/M3](#)