

High Luminous Efficacy  
RGB LED Emitter  
**LZC-00MC40**



## Key Features

- Ultra-bright, Ultra-compact 40W RGB LED
- Full spectrum of brilliant colors with superior color mixing
- Small high density foot print – 9.0mm x 9.0mm x 5.4mm
- Surface mount ceramic package with integrated glass lens
- Exceptionally low Thermal Resistance (0.7°C/W)
- Electrically neutral thermal path
- Extreme Luminous Flux density
- New industry standard for Lumen Maintenance (>90% at 100,000 Hours)
- JEDEC Level 1 for Moisture Sensitivity Level
- Lead (Pb) free and RoHS compliant
- Reflow solderable (up to 6 cycles)
- Emitter available on 3-channel MCPCB (optional)
- Recommended use with LL-3T08 family of High Efficiency / High Uniformity color-mixing lenses for perfect color uniformity

## Typical Applications

- Architectural Lighting
- Entertainment
- Stage and Studio Lighting
- Accent Lighting

## Description

The LZC-00MC40 RGB LED emitter enables a full spectrum of brilliant colors with the highest light output, highest flux density, and superior color mixing available. It outperforms other colored lighting solutions with multiple red, green and blue LED die in a single, compact emitter. With 40W power capability and a 9.0mm x 9.0mm x 5.4mm ultra-small footprint, this package provides exceptional luminous flux density. LedEngin's RGB LED offers ultimate design flexibility with three individually addressable color channels. The patented design with thermally and electrically isolated pads has unparalleled thermal and optical performance. The high quality materials used in the package are chosen to optimize light output and minimize stresses which results in monumental reliability and lumen maintenance. The robust product design thrives in outdoor applications with high ambient temperatures and high humidity.

## Table of Contents

Product Nomenclature .....	3
Average Lumen Maintenance Projections.....	3
Absolute Maximum Ratings .....	4
Optical Characteristics @T <sub>C</sub> = 25°C.....	4
Electrical Characteristics @T <sub>C</sub> = 25°C.....	4
Luminous Flux Bins .....	5
Dominant Wavelength Bins.....	5
Forward Voltage Bin.....	5
Typical Radiation Pattern .....	5
Typical Relative Spectral Power Distribution .....	6
Mechanical Dimensions (mm).....	7
Recommended Solder Pad Layout (mm).....	7
IPC/JEDEC Moisture Sensitivity Level.....	8
Reflow Soldering Profile .....	8
Dominant Wavelength Shift over Temperature .....	9
Typical Relative Light Output.....	10
Typical Relative Light Output over Temperature.....	10
Typical Forward Current Characteristics .....	11
Current Derating .....	11
MCPCB Option – 3 channel RGB configuration.....	12
R <sub>θJ-B</sub> Lookup Table .....	12
3-Channel RGB MCPCB Mechanical Dimensions (mm).....	12
Company Information.....	13

## Product Nomenclature

The LZ Series base part number designation is defined as follows:

L Z A – B C D E F G

Where:

A – designates the number of LED die in the package (“C” for 40W)

B – designates the package level (“0” for Emitter, “8” for 3 channel RGB MCPCB)

C – designates the radiation pattern (“0” for Lambertian)

D and E – designate the color (“MC” for RGB Multi-color Dice)

F and G – designate the package power capability (“40” for 40W typical rating)

Ordering information:

For ordering LedEngin products, please reference the base part number above. The base part number represents any of the flux or dominant wavelength bins specified in the binning tables below. For ordering products with special bin selections, please contact a LedEngin sales representative or authorized distributor.

## Average Lumen Maintenance Projections

Lumen maintenance generally describes the ability of a lamp to retain its output over time. The useful lifetime for solid state lighting devices (Power LEDs) is also defined as Lumen Maintenance, with the percentage of the original light output remaining at a defined time period.

Based on long-term WHTOL testing, LedEngin projects that the LZ Series will deliver, on average, 90% Lumen Maintenance at 100,000 hours of operation at a forward current of 700 mA. This projection is based on constant current operation with junction temperature maintained at or below 125°C.

## Absolute Maximum Ratings

Table 1:

Parameter	Symbol	Value	Unit
DC Forward Current <sup>[1]</sup>	$I_F$	1000	mA
Peak Pulsed Forward Current <sup>[2]</sup>	$I_{FP}$	1500	mA
Reverse Voltage	$V_R$	See Note 3	V
Storage Temperature	$T_{stg}$	-40 ~ +150	°C
Junction Temperature [Blue, Green]	$T_J$	150	°C
Junction Temperature [Red]	$T_J$	125	°C
Soldering Temperature <sup>[4]</sup>	$T_{sol}$	260	°C
Allowable Reflow Cycles		6	
ESD Sensitivity <sup>[5]</sup>		> 8,000 V HBM Class 3B JESD22-A114-D	

Notes for Table 1:

- Maximum DC forward current is determined by the overall thermal resistance and ambient temperature. Follow the curves in Figure 11 for current derating.
- Pulse forward current conditions: Pulse Width  $\leq$  10msec and Duty Cycle  $\leq$  10%.
- LEDs are not designed to be reverse biased.
- Solder conditions per JEDEC 020D. See Reflow Soldering Profile Figure 5.
- LedEngin recommends taking reasonable precautions towards possible ESD damages and handling the LZC-00MC40 in an electrostatic protected area (EPA). An EPA may be adequately protected by ESD controls as outlined in ANSI/ESD S6.1.

## Optical Characteristics @ $T_C = 25^\circ\text{C}$

Table 2:

Parameter	Symbol	Typical			Unit
		Red	Green	Blue <sup>[1]</sup>	
Luminous Flux (@ $I_F = 700\text{mA}$ )	$\Phi_V$	330	430	120	lm
Luminous Flux (@ $I_F = 1000\text{mA}$ )	$\Phi_V$	430	560	155	lm
Dominant Wavelength	$\lambda_D$	625	523	462	nm
Viewing Angle <sup>[2]</sup>	$2\Theta_{1/2}$		95		Degrees
Total Included Angle <sup>[3]</sup>	$\Theta_{0.9}$		115		Degrees

Notes for Table 2:

- When operating the Blue LED, observe IEC 60825-1 class 2 rating. Do not stare into the beam.
- Viewing Angle is the off axis angle from emitter centerline where the luminous intensity is  $\frac{1}{2}$  of the peak value.
- Total Included Angle is the total angle that includes 90% of the total luminous flux.

## Electrical Characteristics @ $T_C = 25^\circ\text{C}$

Table 3:

Parameter	Symbol	Typical			Unit
		4 Red	4 Green	4 Blue	
Forward Voltage (@ $I_F = 700\text{mA}$ )	$V_F$	9.4	16.8	14.0	V
Forward Voltage (@ $I_F = 1000\text{mA}$ )	$V_F$	10.2	18.0	14.6	V
Temperature Coefficient of Forward Voltage	$\Delta V_F / \Delta T_J$	-7.6	-11.6	-12.0	mV/°C
Thermal Resistance (Junction to Case)	$R_{\Theta_{J-C}}$		0.7		°C/W

Note for Table 3:

- Forward Voltage typical value is for all four LED dice from the same color connected in series.

## Luminous Flux Bins

Table 4:

Bin Code	Minimum Luminous Flux ( $\Phi_v$ ) @ $I_F = 700\text{mA}^{[1,2]}$ (lm)			Maximum Luminous Flux ( $\Phi_v$ ) @ $I_F = 700\text{mA}^{[1,2]}$ (lm)			Typical Luminous Flux ( $\Phi_v$ ) @ $I_F = 1000\text{mA}^{[1,2]}$ (lm)		
	4 Red	4 Green	4 Blue	4 Red	4 Green	4 Blue	4 Red	4 Green	4 Blue
	L			93			117		
M			117			146			164
N			146			182			205
R	285			356			388		
S	356	356		445	445		485	486	
T		445			556			607	

Notes for Table 4:

1. Luminous flux performance guaranteed within published operating conditions. LedEngin maintains a tolerance of  $\pm 10\%$  on flux measurements.
2. Each color consists of 4 die in series for binning purposes.

## Dominant Wavelength Bins

Table 5:

Bin Code	Minimum Dominant Wavelength ( $\lambda_D$ ) @ $I_F = 700\text{mA}^{[1]}$ (nm)			Maximum Dominant Wavelength ( $\lambda_D$ ) @ $I_F = 700\text{mA}^{[1]}$ (nm)		
	4 Red	4 Green	4 Blue	4 Red	4 Green	4 Blue
	R2	620			630	
G2		520			525	
G3		525			530	
B4			455			460
B5			460			465
B6			465			470

Notes for Table 5:

1. LedEngin maintains a tolerance of  $\pm 0.5\text{nm}$  on dominant wavelength measurements.

## Forward Voltage Bin

Table 6:

Bin Code	Minimum Forward Voltage ( $V_F$ ) @ $I_F = 700\text{mA}^{[1,2]}$ (V)			Maximum Forward Voltage ( $V_F$ ) @ $I_F = 700\text{mA}^{[1,2]}$ (V)		
	4 Red	4 Green	4 Blue	4 Red	4 Green	4 Blue
	0	8.96	14.72	12.80	12.80	20.48

Notes for Table 6:

1. Forward Voltage is binned with all four LED dice connected in series.
2. LedEngin maintains a tolerance of  $\pm 0.16\text{V}$  for forward voltage measurements for the four LEDs.

## Typical Radiation Pattern

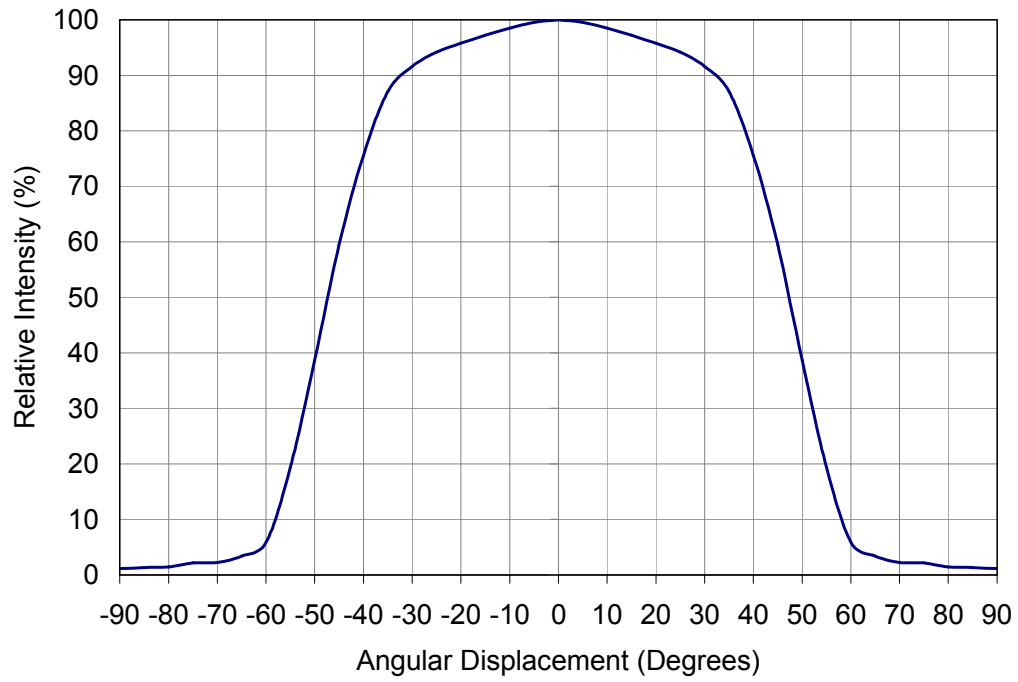

Figure 1: Typical representative spatial radiation pattern.

## Typical Relative Spectral Power Distribution

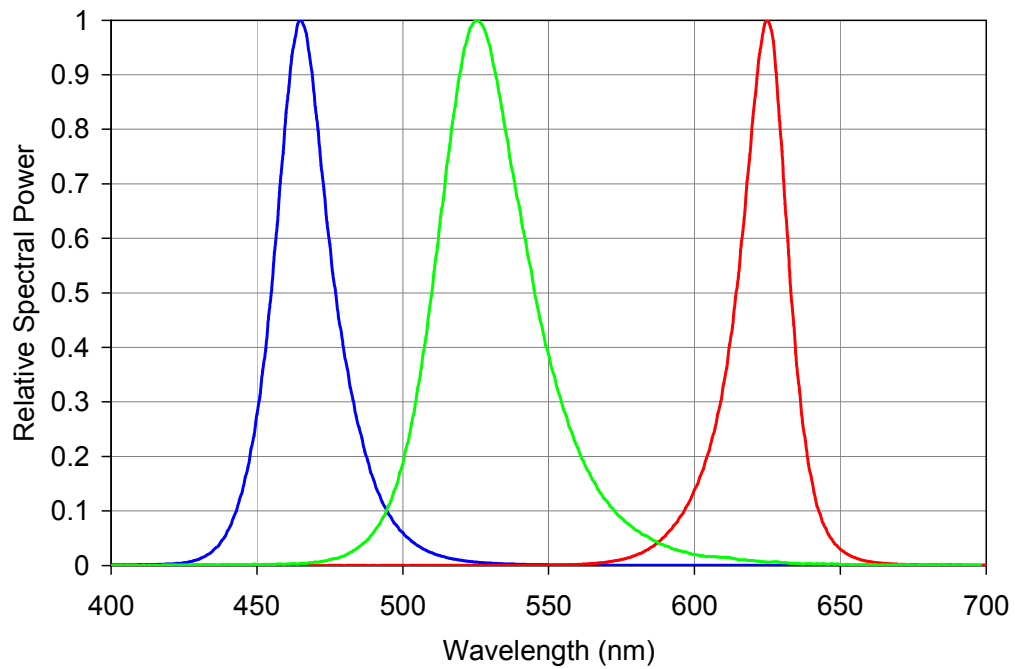

Figure 2: Typical relative spectral power vs. wavelength @  $T_c = 25^\circ\text{C}$ .

## Mechanical Dimensions (mm)

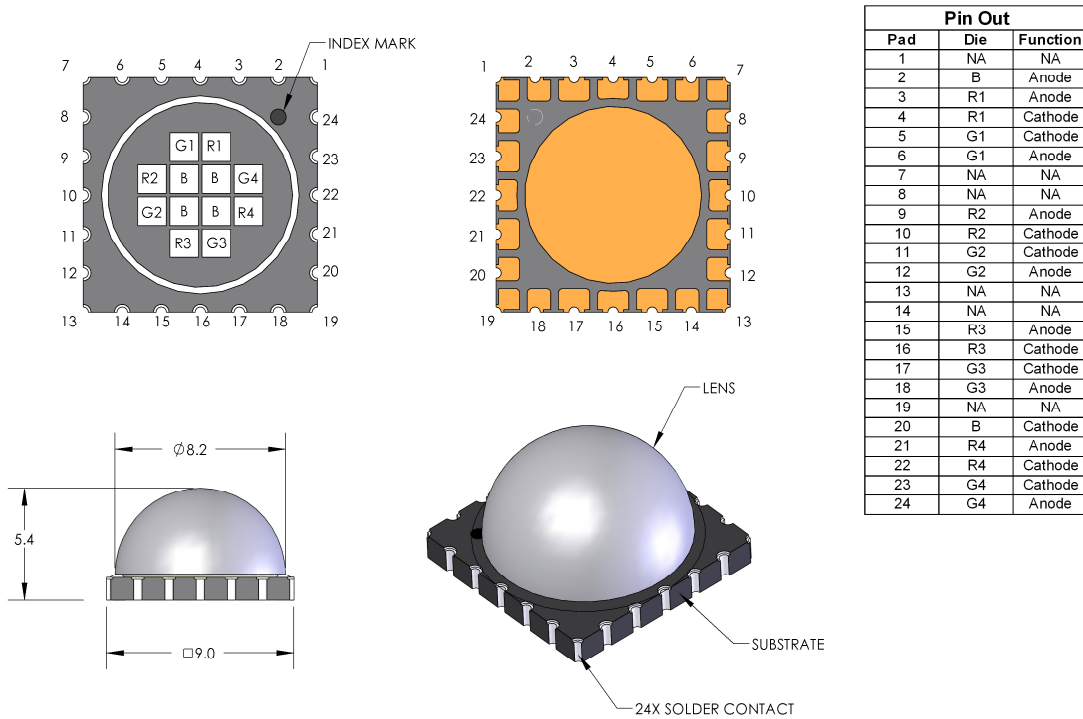

Figure3: Package Outline Drawing

Note for Figure 3:

1. Unless otherwise noted, the tolerance =  $\pm 0.20$  mm.

## Recommended Solder Pad Layout (mm)

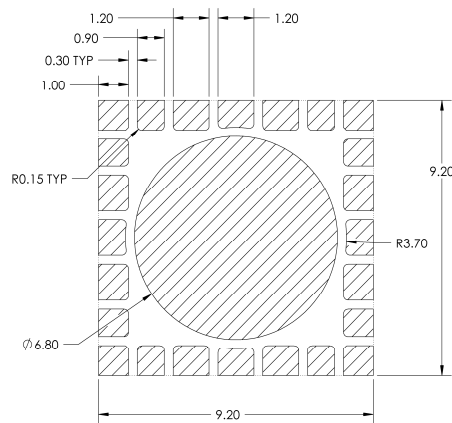

Figure 4: Recommended solder mask opening (hatched area) for anode, cathode, and thermal pad.

Note for Figure 4:

2. Unless otherwise noted, the tolerance =  $\pm 0.20$  mm.
3. Recommended stencil thickness is 125 $\mu$ m.

## IPC/JEDEC Moisture Sensitivity Level

Table 7 - IPC/JEDEC J-STD-20D.1 MSL Classification:

Level	Floor Life		Soak Requirements			
	Time	Conditions	Standard Time (hrs)	Standard Conditions	Accelerated Time (hrs)	Accelerated Conditions
1	Unlimited	≤ 30°C/ 85% RH	168 +5/-0	85°C/ 85% RH	n/a	n/a

Notes for Table 7:

- The standard soak time includes a default value of 24 hours for semiconductor manufacturer's exposure time (MET) between bake and bag and includes the maximum time allowed out of the bag at the distributor's facility.

## Reflow Soldering Profile

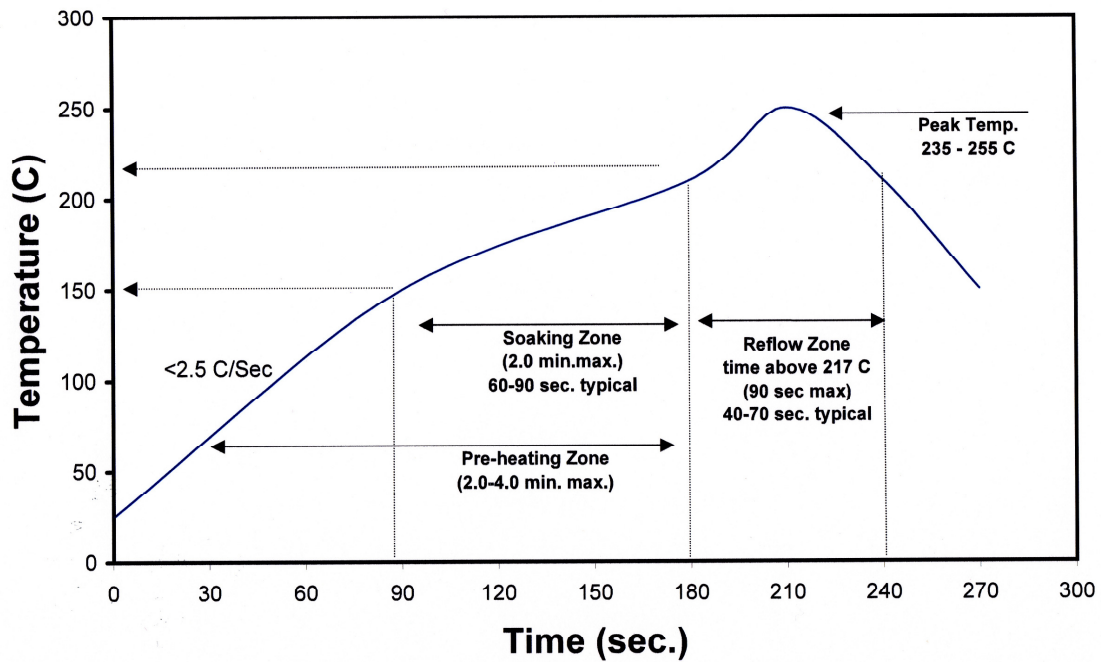

Figure 5: Reflow soldering profile for lead free soldering.



## Typical Dominant Wavelength Shift over Forward Current

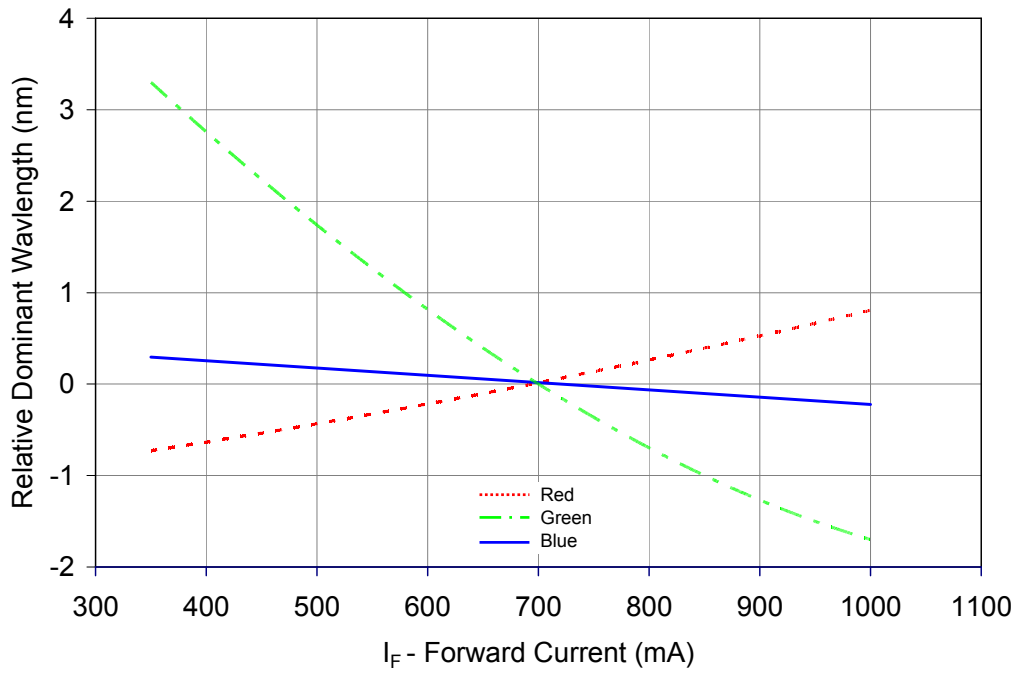

Figure 6: Typical dominant wavelength shift vs. forward current @  $T_c = 25^\circ\text{C}$ .

## Dominant Wavelength Shift over Temperature

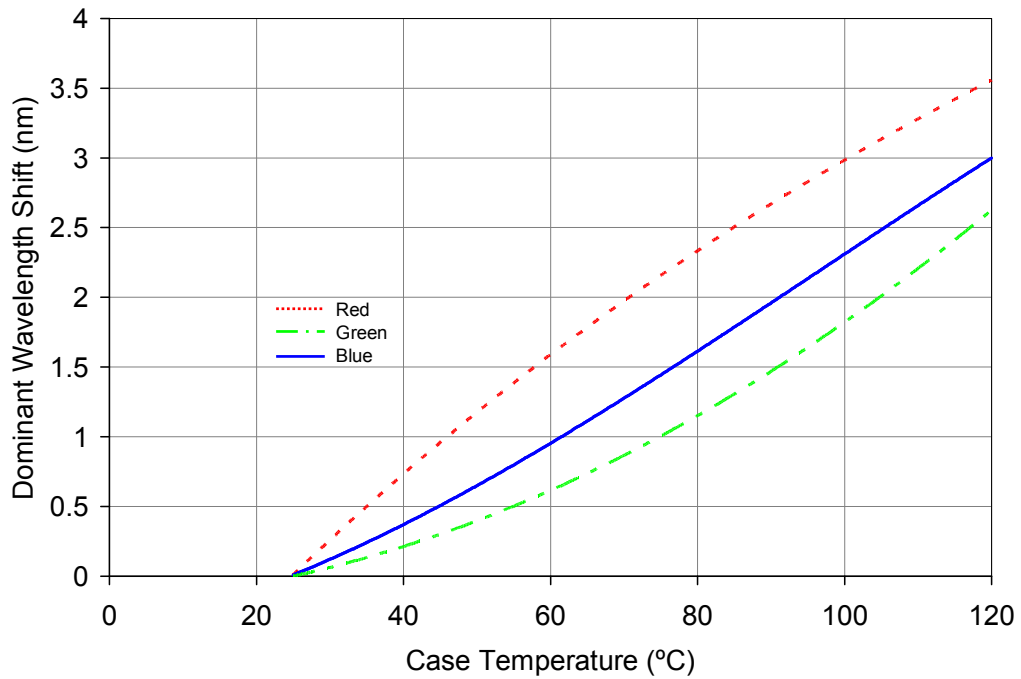

Figure 7: Typical dominant wavelength shift vs. case temperature.

## Typical Relative Light Output

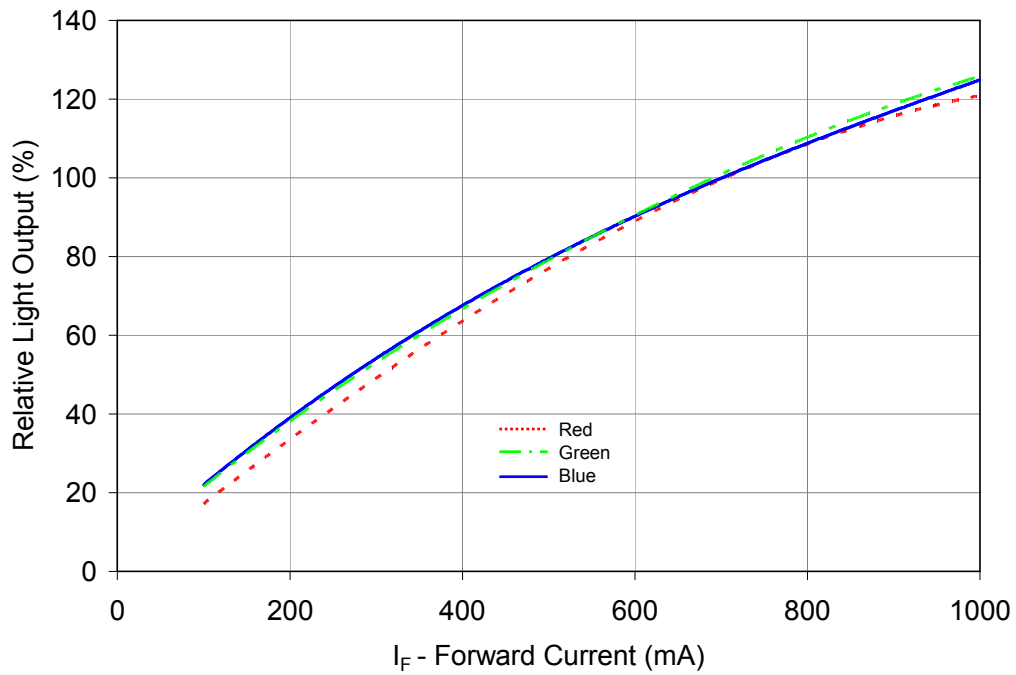

Figure 8: Typical relative light output vs. forward current @  $T_C = 25^\circ\text{C}$ .

## Typical Relative Light Output over Temperature

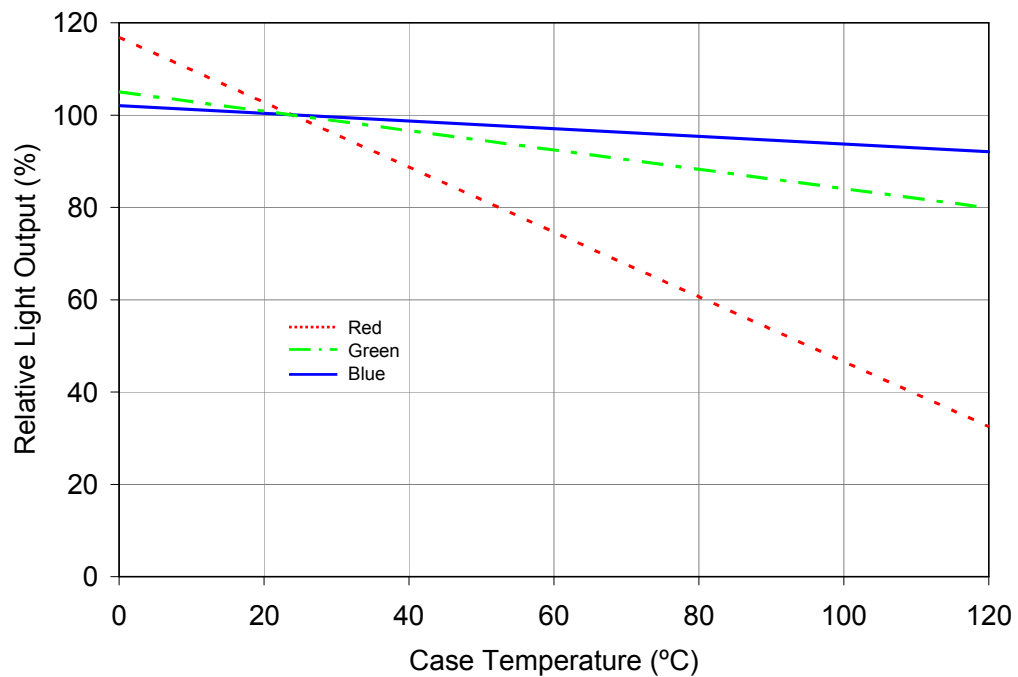

Figure 9: Typical relative light output vs. case temperature.

## Typical Forward Current Characteristics

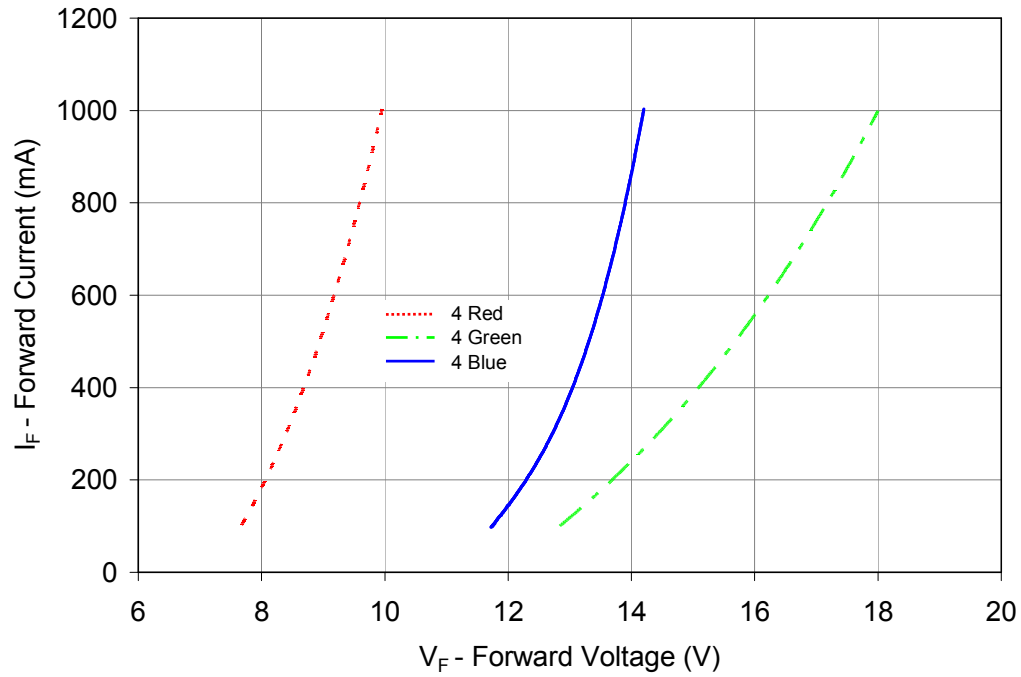

Figure 10: Typical forward current vs. forward voltage @  $T_C = 25^\circ\text{C}$ .

## Current Derating

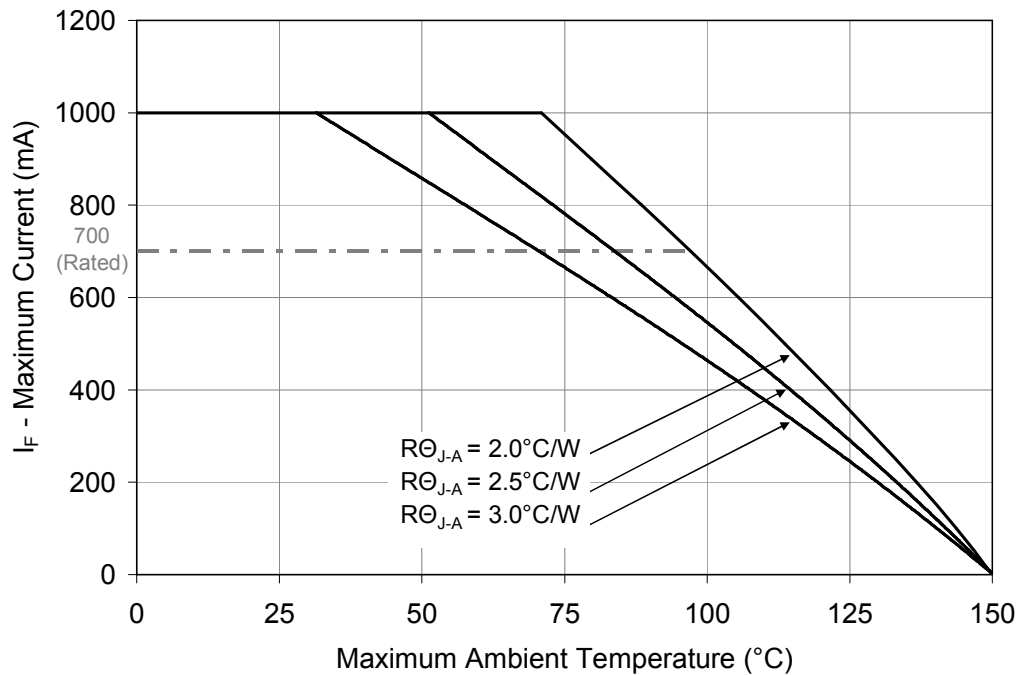

Figure 11: Maximum forward current vs. ambient temperature based on  $T_{J(\text{MAX})} = 150^\circ\text{C}$ .

Notes for Figure 11:

1. Maximum current assumes that all 12 LED dice are operating concurrently at the same current.
2.  $R\theta_{J-C}$  [Junction to Case Thermal Resistance] for the LZC-00MC40 is typically 0.7°C/W.
3.  $R\theta_{J-A}$  [Junction to Ambient Thermal Resistance] =  $R\theta_{J-C}$  +  $R\theta_{C-A}$  [Case to Ambient Thermal Resistance].

## MCPCB Option – 3 channel RGB configuration

- Typical Thermal Resistance for MCPCB adds only 0.8°C/W
- 3-channel configuration allows for easy driver control
- MCPCB contains Zener Diodes for enhanced ESD protection

The LZC-80MC40 3-channel RGB MCPCB option provides a convenient method to mount LedEngin's RGB color 40W emitters. The six recessed features allow the use of M3 or #4 screws to attach the MCPCB to a heat sink. The MCPCB also contains Zener diodes for enhanced ESD protection.

### $RO_{J-B}$ Lookup Table

Table 8:

Product	Typical Emitter $RO_{J-C}$	+	RGB MCPCB $RO_{C-B}$	=	Typical Emitter + MCPCB $RO_{J-B}$ <sup>[1]</sup>
40W	0.7°C/W	+	0.8°C/W	=	1.5°C/W

### 3-Channel RGB MCPCB Mechanical Dimensions (mm)

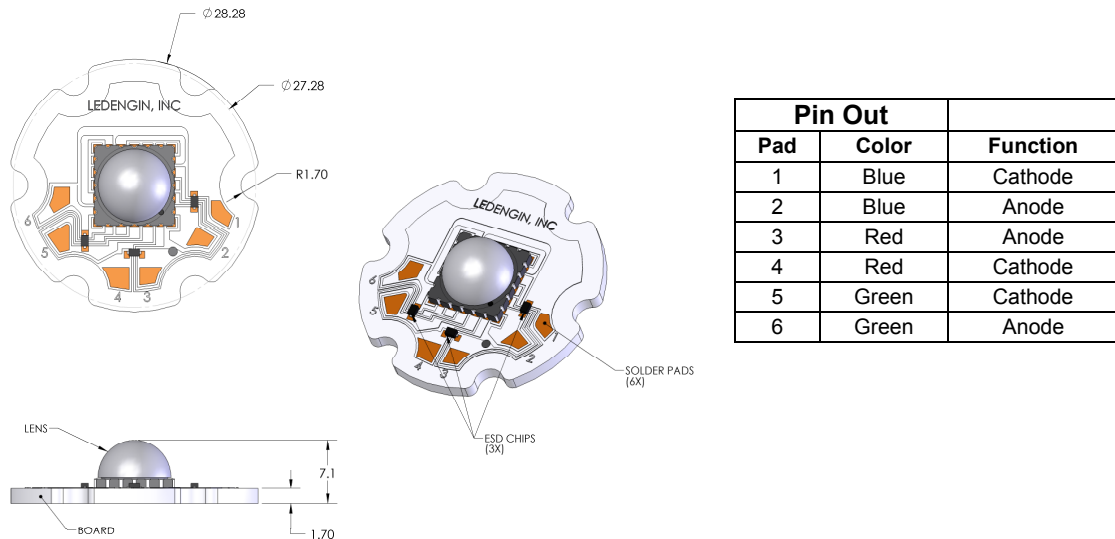

Figure 12: Standard MCPCB outline dimensions (mm).

Notes for Figure 12:

1. Unless otherwise noted, the tolerance =  $\pm 0.20$  mm.
2. Slots in MCPCB are for M3 or #4 mounting screws.
3. LedEngin lens and lens holder family LLxx-3T08-H align with the MCPCB cutouts.
4. LedEngin recommends using plastic washers to electrically insulate screws from solder pads and electrical traces.
5. LedEngin recommends using thin thermally conductive tape or adhesives when attaching MCPCB to a heat sink.

## Company Information

LedEngin, Inc. is a Silicon Valley based solid-state lighting company specializing in the development and manufacturing of unprecedented high-power LED emitters, modules and replacement lamps. LedEngin's packaging technologies lead the industry with products that feature lowest thermal resistance, highest flux density and consummate reliability, enabling compact and efficient solid state lighting solutions.

LedEngin's LED emitters range from 3W to 40W with ultra-compact footprints and are available in single color products including Cool White, Neutral White, Warm White, Red, Green, Blue, Amber, Deep Red, Far Red, Dental Blue and UV as well as multi-color products with RGB, RGBA and RGBW options. LedEngin's brightest White LEDs are capable of emitting 2,000 lumens.

LedEngin's robust emitters are at the core of its unique line of modules and replacement lamps producing unmatched beam quality resulting in true Lux on Target™ for a wide variety of spot and narrow flood directional lighting applications.

LedEngin is committed to providing products that conserve natural resources and reduce greenhouse emissions.

LedEngin reserves the right to make changes to improve performance without notice.

Please contact [Sales@ledengin.com](mailto:Sales@ledengin.com) or (408) 492-0620 for more information.

# Mouser Electronics

Authorized Distributor

Click to View Pricing, Inventory, Delivery & Lifecycle Information:

[LED Engin:](#)

[LZC-80MC40](#) [LZC-00MC40](#)