

NTR4170N

MOSFET – Power, Single, N-Channel, SOT-23

30 V, 3.1 A

Features

- Low $R_{DS(on)}$
- Low Gate Charge
- Low Threshold Voltage
- Halide Free
- This is a Pb-Free Device

Applications

- Power Converters for Portables
- Battery Management
- Load/Power Switch

MAXIMUM RATINGS ($T_J = 25^\circ\text{C}$ unless otherwise noted)

Parameter	Symbol	Value	Unit		
Drain-to-Source Voltage	V_{DSS}	30	V		
Gate-to-Source Voltage	V_{GS}	± 12	V		
Continuous Drain Current (Note 1)	Steady State	$T_A = 25^\circ\text{C}$	2.4	A	
			$t \leq 30$ s		3.1
			$t \leq 10$ s		3.9
	Steady State	$T_A = 85^\circ\text{C}$	1.7		
			$t \leq 30$ s		2.3
			$t \leq 10$ s		2.8
Power Dissipation (Note 1)	Steady State	$T_A = 25^\circ\text{C}$	P_D	0.48	W
			$t \leq 30$ s	0.82	
			$t \leq 10$ s	P_D	1.25
Pulsed Drain Current	$t_p = 10 \mu\text{s}$	I_{DM}	8.0	A	
Operating Junction and Storage Temperature	T_J, T_{stg}	-55 to 150	$^\circ\text{C}$		
Source Current (Body Diode)	I_S	0.82	A		
Lead Temperature for Soldering Purposes (1/8" from case for 10 s)	T_L	260	$^\circ\text{C}$		

Stresses exceeding those listed in the Maximum Ratings table may damage the device. If any of these limits are exceeded, device functionality should not be assumed, damage may occur and reliability may be affected.

THERMAL RESISTANCE RATINGS

Parameter	Symbol	Max	Unit
Junction-to-Ambient – Steady State (Note 1)	$R_{\theta JA}$	260	$^\circ\text{C/W}$
Junction-to-Ambient – $t \leq 30$ s	$R_{\theta JA}$	153	
Junction-to-Ambient – $t < 10$ s (Note 1)	$R_{\theta JA}$	100	



ON Semiconductor®

www.onsemi.com

$V_{(BR)DSS}$	$R_{DS(on)}$ MAX	I_D MAX
30 V	55 m Ω @ 10 V	3.1 A
	70 m Ω @ 4.5 V	2.8 A
	110 m Ω @ 2.5 V	2.0 A

SIMPLIFIED SCHEMATIC – N-CHANNEL

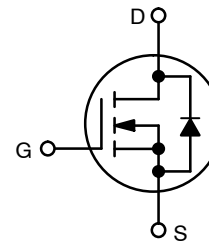

MARKING DIAGRAM/ PIN ASSIGNMENT

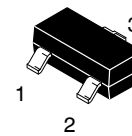

**SOT-23
CASE 318
STYLE 21**

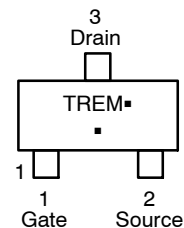

TRE = Specific Device Code

M = Date Code

▪ = Pb-Free Package

(Note: Microdot may be in either location)

ORDERING INFORMATION

Device	Package	Shipping†
NTR4170NT1G	SOT-23 (Pb-Free)	3000/Tape & Reel
NTR4170NT3G	SOT-23 (Pb-Free)	10000/Tape & Reel

†For information on tape and reel specifications, including part orientation and tape sizes, please refer to our Tape and Reel Packaging Specification Brochure, BRD8011/D.

NTR4170N

1. Surface-mounted on FR4 board using 1 in sq pad size (Cu area = 1.127 in sq [2 oz] including traces).

NTR4170N

ELECTRICAL CHARACTERISTICS (T_J = 25°C unless otherwise noted)

Parameter	Symbol	Test Conditions	Min	Typ	Max	Units
OFF CHARACTERISTICS						
Drain-to-Source Breakdown Voltage	V _{(BR)DSS}	V _{GS} = 0 V, I _D = 250 μA	30			V
Drain-to-Source Breakdown Voltage Temperature Coefficient	V _{(BR)DSS} / T _J	I _D = 250 μA, Reference to 25°C		26.4		mV/°C
Zero Gate Voltage Drain Current	I _{DSS}	V _{GS} = 0 V, V _{DS} = 24 V, T _J = 25°C V _{GS} = 0 V, V _{DS} = 24 V, T _J = 125°C			1.0 5.0	μA
Gate-to-Source Leakage Current	I _{GSS}	V _{DS} = 0 V, V _{GS} = ±12 V			±100	nA

ON CHARACTERISTICS (Note 3)

Gate Threshold Voltage	V _{GS(TH)}	V _{GS} = V _{DS} , I _D = 250 μA	0.6	1.0	1.4	V
Negative Threshold Temperature Coefficient	V _{GS(TH)} / T _J			3.3		mV/°C
Drain-to-Source On-Resistance	R _{DS(on)}	V _{GS} = 10 V, I _D = 3.2 A		45	55	mΩ
		V _{GS} = 4.5 V, I _D = 2.8 A		50	70	
		V _{GS} = 2.5 V, I _D = 2.0 A		64	110	
Forward Transconductance	g _{FS}	V _{DS} = 5.0 V, I _D = 3.2 A		8.0		S

CHARGES, CAPACITANCES AND GATE RESISTANCE

Input Capacitance	C _{iss}	V _{GS} = 0 V, f = 1.0 MHz, V _{DS} = 15 V		432		pF
Output Capacitance	C _{oss}			53.6		
Reverse Transfer Capacitance	C _{rss}			37.1		
Total Gate Charge	Q _{G(TOT)}	V _{GS} = 4.5 V, V _{DS} = 15 V, I _D = 3.2 A		4.76		nC
Threshold Gate Charge	Q _{G(TH)}			0.3		
Gate-to-Source Charge	Q _{GS}			1.0		
Gate-to-Drain Charge	Q _{GD}			1.4		
Gate Resistance	R _G			3.8		Ω

SWITCHING CHARACTERISTICS, V_{GS} = 4.5 V (Note 4)

Turn-On Delay Time	t _{d(on)}	V _{GS} = 4.5 V, V _{DD} = 15 V, I _D = 3.2 A, R _G = 6.2 Ω		6.4		ns
Rise Time	t _r			9.9		
Turn-Off Delay Time	t _{d(off)}			15.1		
Fall Time	t _f			3.5		

DRAIN-SOURCE DIODE CHARACTERISTICS

Forward Diode Voltage	V _{SD}	V _{GS} = 0 V, I _S = 1.0 A, T _J = 25°C		0.75	1.0	V
Reverse Recovery Time	t _{RR}	V _{GS} = 0 V, I _S = 1.0 A, dI _{SD} /dt = 100 A/μs		8.0		ns
Charge Time	t _a			5.1		
Discharge Time	t _b			2.9		
Reverse Recovery Charge	Q _{RR}			2.9		nC

Product parametric performance is indicated in the Electrical Characteristics for the listed test conditions, unless otherwise noted. Product performance may not be indicated by the Electrical Characteristics if operated under different conditions.

- Surface-mounted on FR4 board using 1 in sq pad size (CU area = 1.127 in sq [2 oz] including traces).
- Pulse Test: Pulse Width ≤ 300 μs, Duty Cycle ≤ 2%.
- Switching characteristics are independent of operating junction temperatures.

NTR4170N

TYPICAL CHARACTERISTICS

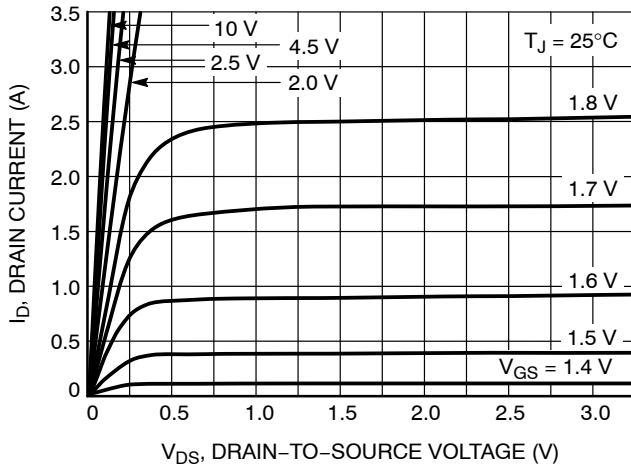

Figure 1. On-Region Characteristics

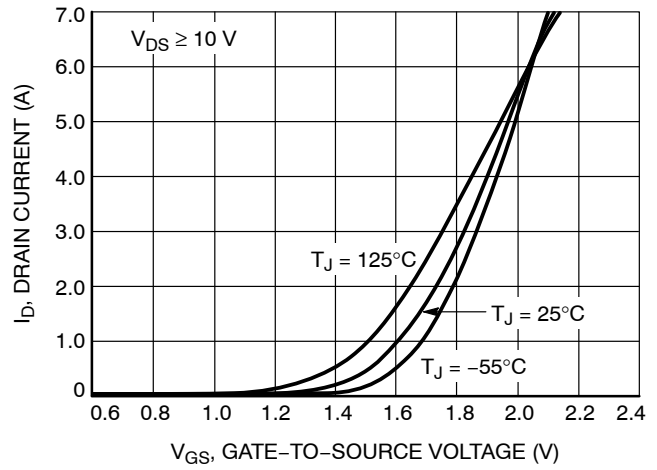

Figure 2. Transfer Characteristics

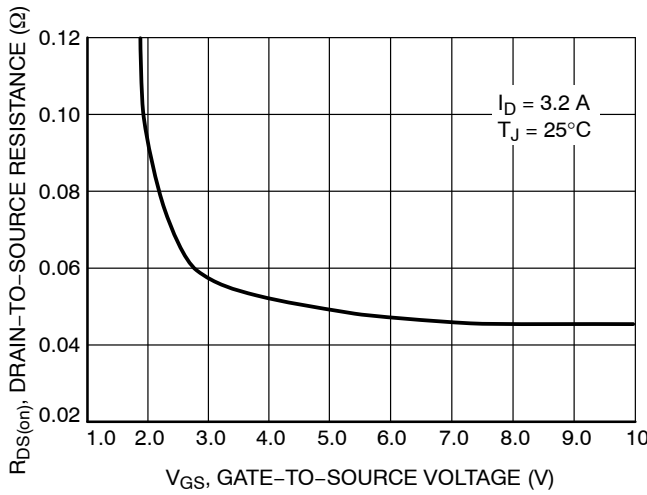

Figure 3. On-Resistance vs. Gate Voltage

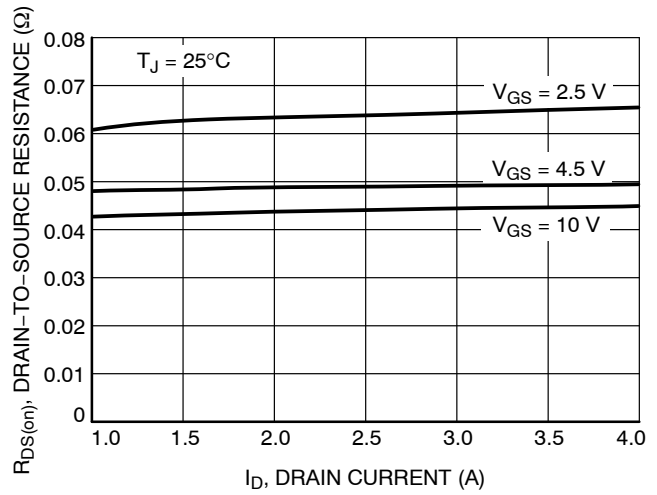

Figure 4. On-Resistance vs. Drain Current and Gate Voltage

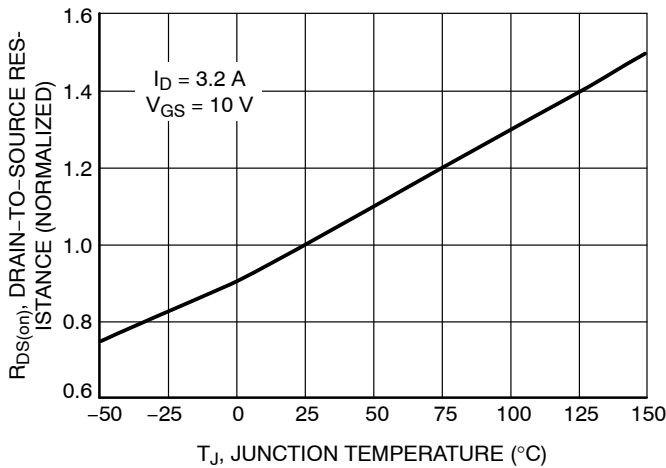

Figure 5. On-Resistance Variation with Temperature

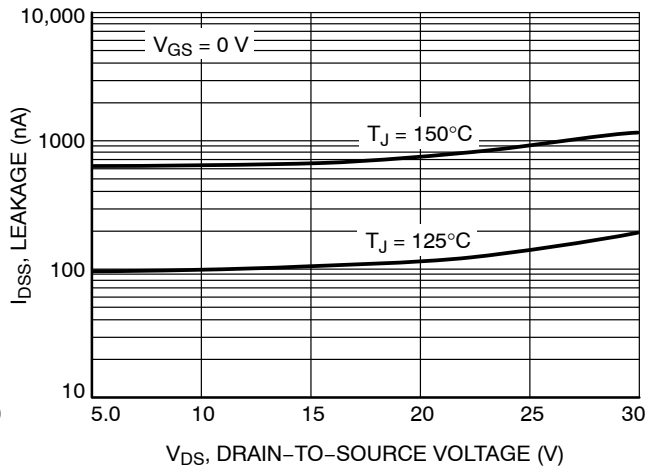

Figure 6. Drain-to-Source Leakage Current vs. Voltage

TYPICAL CHARACTERISTICS

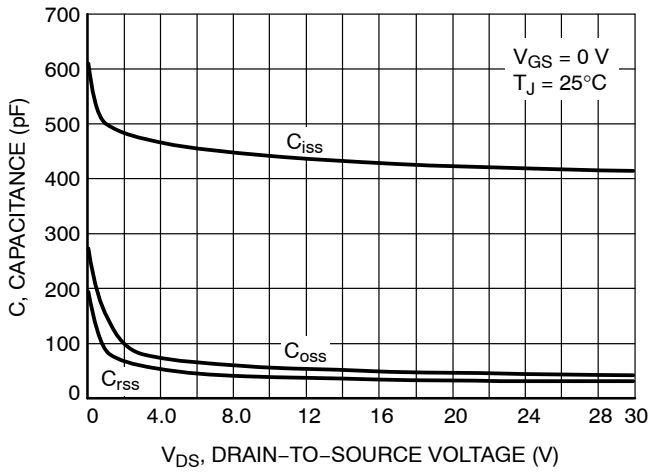

Figure 7. Capacitance Variation

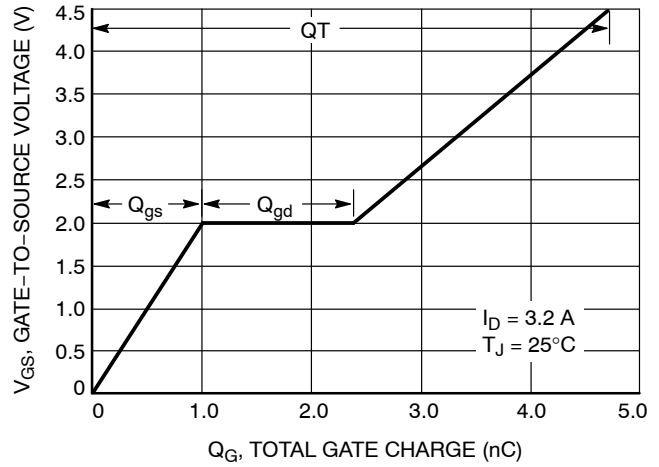

Figure 8. Gate-to-Source Voltage vs. Total Charge

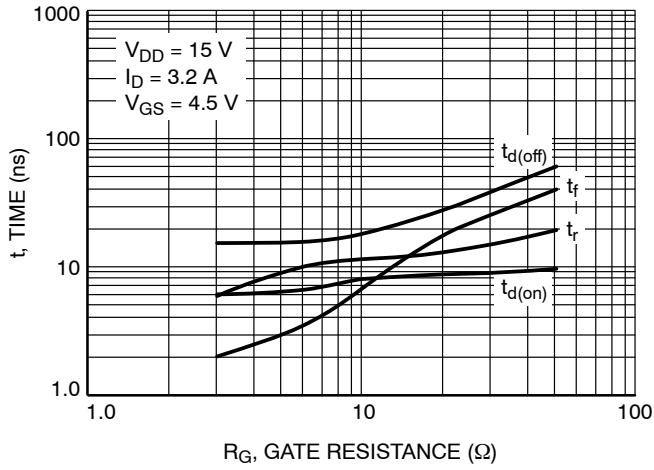

Figure 9. Resistive Switching Time Variation vs. Gate Resistance

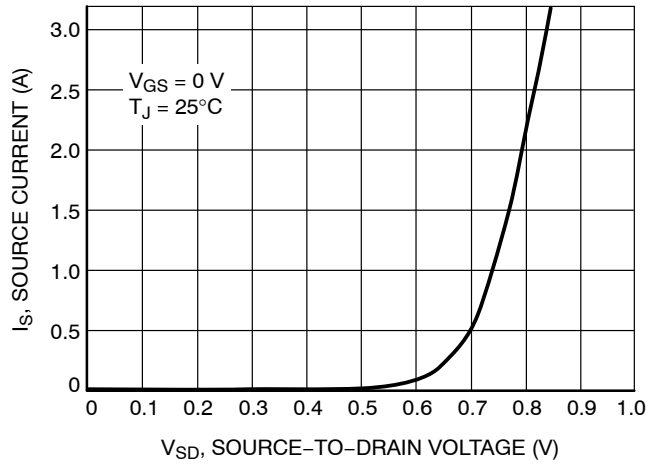
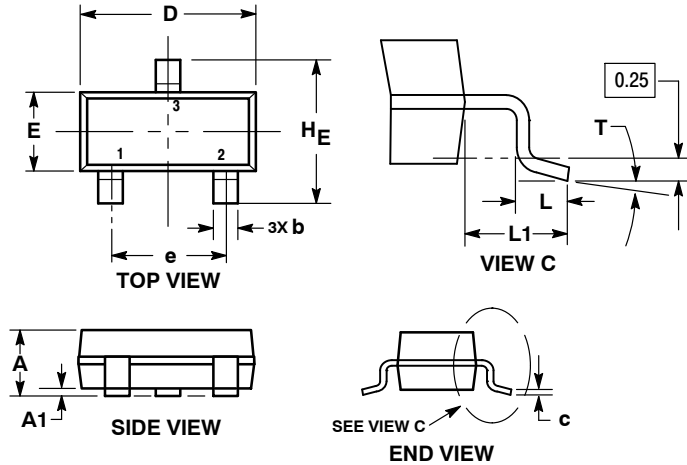

Figure 10. Diode Forward Voltage vs. Current

NTR4170N

PACKAGE DIMENSIONS

SOT-23 (TO-236)
CASE 318-08
ISSUE AR



NOTES:

1. DIMENSIONING AND TOLERANCING PER ASME Y14.5M, 1994.
2. CONTROLLING DIMENSION: MILLIMETERS.
3. MAXIMUM LEAD THICKNESS INCLUDES LEAD FINISH. MINIMUM LEAD THICKNESS IS THE MINIMUM THICKNESS OF THE BASE MATERIAL.
4. DIMENSIONS D AND E DO NOT INCLUDE MOLD FLASH, PROTRUSIONS, OR GATE BURRS.

DIM	MILLIMETERS			INCHES		
	MIN	NOM	MAX	MIN	NOM	MAX
A	0.89	1.00	1.11	0.035	0.039	0.044
A1	0.01	0.06	0.10	0.000	0.002	0.004
b	0.37	0.44	0.50	0.015	0.017	0.020
c	0.08	0.14	0.20	0.003	0.006	0.008
D	2.80	2.90	3.04	0.110	0.114	0.120
E	1.20	1.30	1.40	0.047	0.051	0.055
e	1.78	1.90	2.04	0.070	0.075	0.080
L	0.30	0.43	0.55	0.012	0.017	0.022
L1	0.35	0.54	0.69	0.014	0.021	0.027
HE	2.10	2.40	2.64	0.083	0.094	0.104
T	0°	---	10°	0°	---	10°

STYLE 21:

- PIN 1. GATE
- SOURCE
- DRAIN

RECOMMENDED SOLDERING FOOTPRINT*

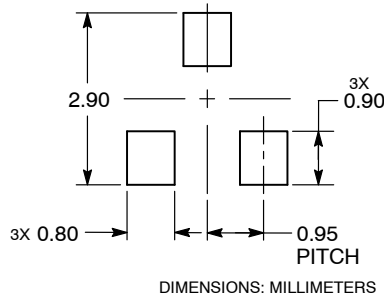

*For additional information on our Pb-Free strategy and soldering details, please download the ON Semiconductor Soldering and Mounting Techniques Reference Manual, SOLDERM/D.

ON Semiconductor and are trademarks of Semiconductor Components Industries, LLC dba ON Semiconductor or its subsidiaries in the United States and/or other countries. ON Semiconductor owns the rights to a number of patents, trademarks, copyrights, trade secrets, and other intellectual property. A listing of ON Semiconductor's product/patent coverage may be accessed at www.onsemi.com/site/pdf/Patent-Marking.pdf. ON Semiconductor reserves the right to make changes without further notice to any products herein. ON Semiconductor makes no warranty, representation or guarantee regarding the suitability of its products for any particular purpose, nor does ON Semiconductor assume any liability arising out of the application or use of any product or circuit, and specifically disclaims any and all liability, including without limitation special, consequential or incidental damages. Buyer is responsible for its products and applications using ON Semiconductor products, including compliance with all laws, regulations and safety requirements or standards, regardless of any support or applications information provided by ON Semiconductor. "Typical" parameters which may be provided in ON Semiconductor data sheets and/or specifications can and do vary in different applications and actual performance may vary over time. All operating parameters, including "Typicals" must be validated for each customer application by customer's technical experts. ON Semiconductor does not convey any license under its patent rights nor the rights of others. ON Semiconductor products are not designed, intended, or authorized for use as a critical component in life support systems or any FDA Class 3 medical devices or medical devices with a same or similar classification in a foreign jurisdiction or any devices intended for implantation in the human body. Should Buyer purchase or use ON Semiconductor products for any such unintended or unauthorized application, Buyer shall indemnify and hold ON Semiconductor and its officers, employees, subsidiaries, affiliates, and distributors harmless against all claims, costs, damages, and expenses, and reasonable attorney fees arising out of, directly or indirectly, any claim of personal injury or death associated with such unintended or unauthorized use, even if such claim alleges that ON Semiconductor was negligent regarding the design or manufacture of the part. ON Semiconductor is an Equal Opportunity/Affirmative Action Employer. This literature is subject to all applicable copyright laws and is not for resale in any manner.

PUBLICATION ORDERING INFORMATION

LITERATURE FULFILLMENT:
Literature Distribution Center for ON Semiconductor
19521 E. 32nd Pkwy, Aurora, Colorado 80011 USA
Phone: 303-675-2175 or 800-344-3860 Toll Free USA/Canada
Fax: 303-675-2176 or 800-344-3867 Toll Free USA/Canada
Email: orderlit@onsemi.com

N. American Technical Support: 800-282-9855 Toll Free
USA/Canada
Europe, Middle East and Africa Technical Support:
Phone: 421 33 790 2910
Japan Customer Focus Center
Phone: 81-3-5817-1050

ON Semiconductor Website: www.onsemi.com
Order Literature: <http://www.onsemi.com/orderlit>

For additional information, please contact your local Sales Representative

Mouser Electronics

Authorized Distributor

Click to View Pricing, Inventory, Delivery & Lifecycle Information:

[ON Semiconductor:](#)

[NTR4170NT1G](#)