

RF Transistor, NPN Single

12 V, 100 mA, $f_T = 6.7$ GHz

NSVF6001SB6

This RF transistor is designed for low noise amplifier applications. CPH package is suitable for use under high temperature environment because it has superior heat radiation characteristics. This RF transistor is AEC-Q101 qualified and PPAP capable for automotive applications.

Features

- Input Voltage Operation: up to 32 V
- High Gain: $|S_{21e}|^2 = 11$ dB typ ($f = 1$ GHz)
- High Cut-off Frequency: $f_T = 6.7$ GHz Typ
- Miniature and Thin 6 Pin Package
- High Collector Dissipation (800 mW)
- AEC-Q101 Qualified and PPAP Capable
- These Devices are Pb-Free, Halogen Free and are RoHS Compliant

Typical Applications

- Low Noise Amplifier for FM Radio
- Low Noise Amplifier for TV

ABSOLUTE MAXIMUM RATINGS ($T_A = 25^\circ\text{C}$)

Symbol	Parameter	Value	Unit
V_{CBO}	Collector to Base Voltage	20	V
V_{CEO}	Collector to Emitter Voltage	12	V
V_{EBO}	Emitter to Base Voltage	2	V
I_C	Collector Current	100	mA
P_C	Collector Dissipation (Note 1)	800	mW
T_j, T_{stg}	Operating Junction and Storage Temperature	-55 to +150	$^\circ\text{C}$

Stresses exceeding those listed in the Maximum Ratings table may damage the device. If any of these limits are exceeded, device functionality should not be assumed, damage may occur and reliability may be affected.

1. Surface mounted on ceramic substrate ($250\text{ mm}^2 \times 0.8\text{ mm}$).

Table 1. ELECTRICAL CHARACTERISTICS ($T_A = 25^\circ\text{C}$)

Symbol	Parameter	Conditions	Min	Typ	Max	Unit
I_{CBO}	Collector Cutoff Current	$V_{CB} = 10\text{ V}, I_E = 0\text{ A}$	-	-	1.0	μA
I_{EBO}	Emitter Cutoff Current	$V_{EB} = 1\text{ V}, I_C = 0\text{ A}$	-	-	10	μA
h_{FE1}	DC Current Gain	$V_{CE} = 5\text{ V}, I_C = 30\text{ mA}$	90	-	180	
h_{FE2}		$V_{CE} = 5\text{ V}, I_C = 70\text{ mA}$	70	-	-	
f_T	Gain-Bandwidth Product	$V_{CE} = 5\text{ V}, I_C = 30\text{ mA}$	5	6.7	-	GHz
C_{ob}	Output Capacitance	$V_{CB} = 5\text{ V}, f = 1\text{ MHz}$	-	0.95	1.5	pF
C_{re}	Reverse Transfer Capacitance		-	0.6	-	pF
$ S_{21e} ^2$	Forward Transfer Gain	$V_{CE} = 5\text{ V}, I_C = 30\text{ mA}, f = 1\text{ GHz}$	9	11	-	dB
NF	Noise Figure	$V_{CE} = 5\text{ V}, I_C = 7\text{ mA}, f = 1\text{ GHz}$	-	1.1	2.0	dB

Product parametric performance is indicated in the Electrical Characteristics for the listed test conditions, unless otherwise noted. Product performance may not be indicated by the Electrical Characteristics if operated under different conditions.

2. Pay attention to handling since it is liable to be affected by static electricity due to the high-frequency process adopted.

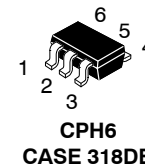

ELECTRICAL CONNECTION

NPN

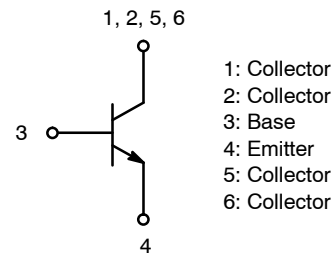

MARKING DIAGRAM

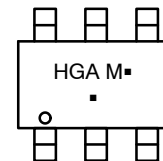

HGA = Specific Device Code
M = One Digit Data Code
▪ = Pb-Free Marking

ORDERING INFORMATION

Device	Package	Shipping†
NSVF6001SB6T1G	CPH6 (Pb-Free / Halogen Free)	3,000 / Tape & Reel

†For information on tape and reel specifications, including part orientation and tape sizes, please refer to our Tape and Reel Packaging Specification Brochure, [BRD8011/D](#).

NSVF6001SB6

TYPICAL CHARACTERISTICS

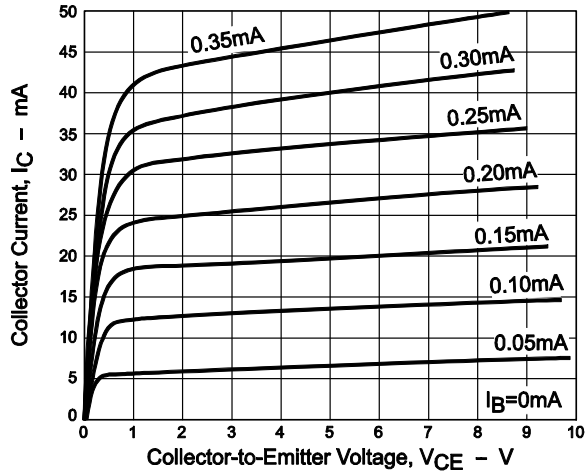

Figure 1. $I_{CE} - V_{CE}$

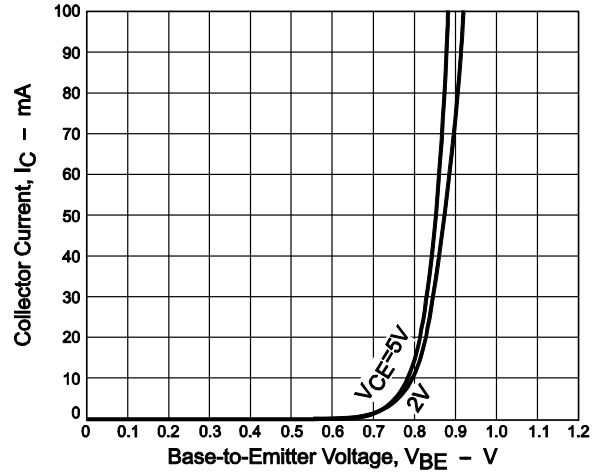

Figure 2. $I_C - V_{BE}$

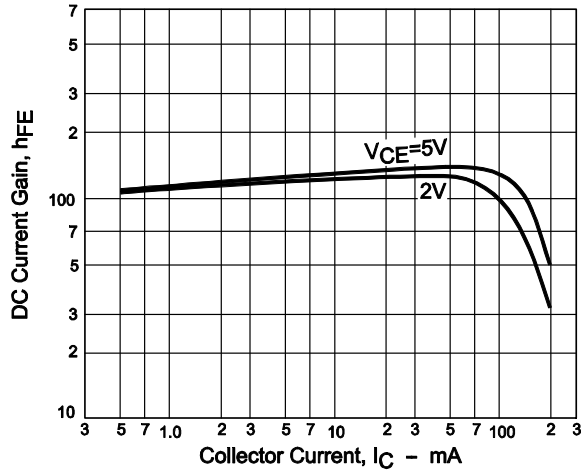

Figure 3. $h_{FE} - I_C$

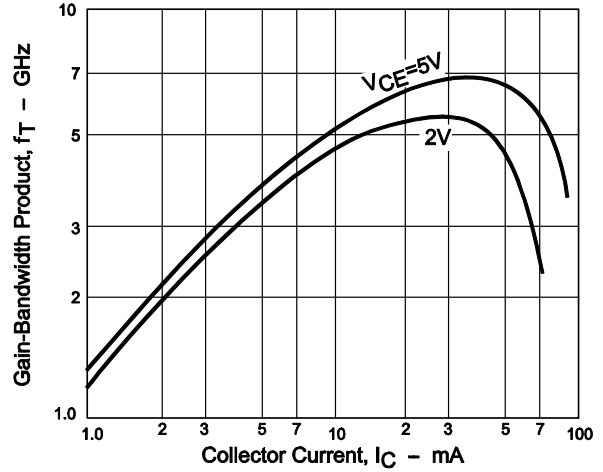

Figure 4. $f_T - I_C$

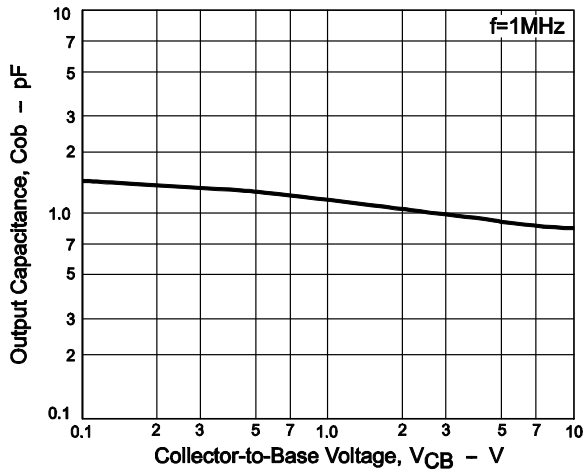

Figure 5. $C_{ob} - V_{CB}$

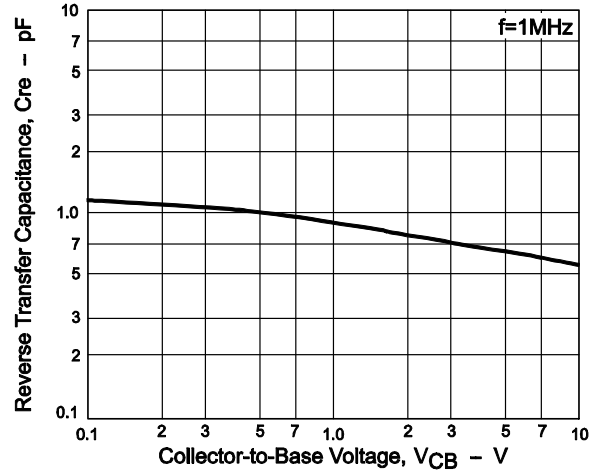

Figure 6. $C_{re} - V_{CB}$

NSVF6001SB6

TYPICAL CHARACTERISTICS (continued)

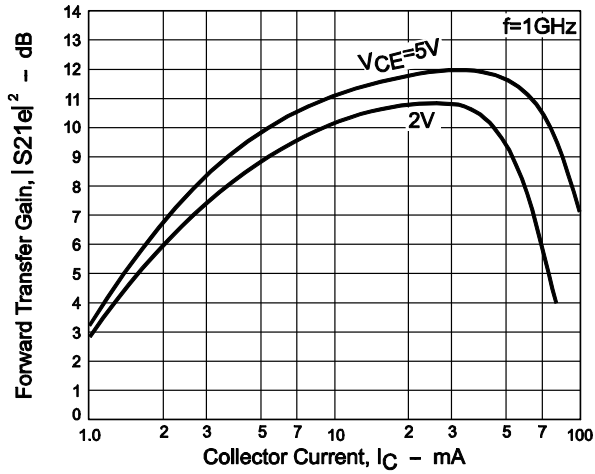

Figure 7. $|S_{21E}|^2 - I_C$

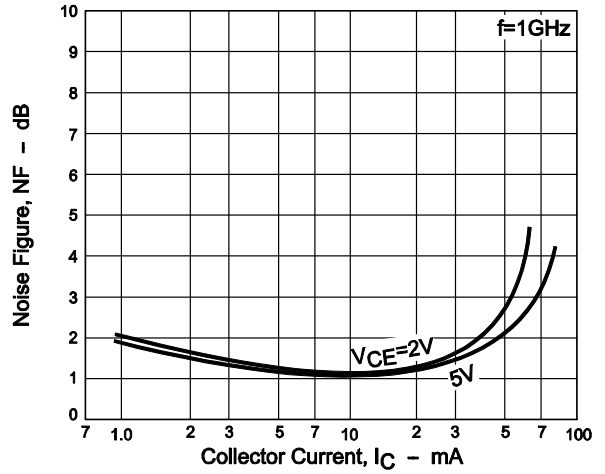

Figure 8. NF - I_C

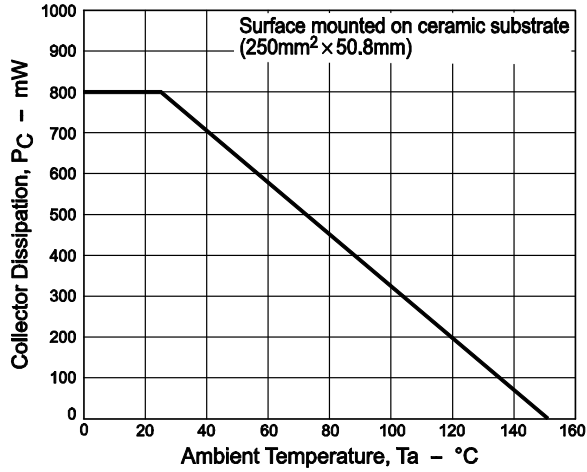

Figure 9. $P_C - T_A$

NSVF6001SB6

S Parameters (Common emitter)

V_{CE}=2V, I_C=5mA, Z_O=50Ω

Freq(MHz)	S ₁₁	∠S ₁₁	S ₂₁	∠S ₂₁	S ₁₂	∠S ₁₂	S ₂₂	∠S ₂₂
100	0.799	-48.2	12.990	147.1	0.044	65.4	0.871	-26.6
200	0.678	-83.5	9.939	125.1	0.069	51.4	0.687	-42.9
400	0.557	-124.8	6.138	101.0	0.090	42.3	0.476	-57.0
600	0.514	-147.5	4.326	87.6	0.103	41.5	0.390	-63.7
800	0.497	-161.9	3.345	77.6	0.115	43.4	0.353	-69.1
1000	0.488	-173.8	2.740	68.9	0.129	45.3	0.337	-74.6
1200	0.484	177.2	2.324	61.3	0.144	46.7	0.335	-79.9
1400	0.484	169.3	2.030	54.5	0.150	47.8	0.340	-85.1
1600	0.483	161.1	1.804	48.3	0.177	48.3	0.346	-90.6
1800	0.482	153.5	1.638	42.3	0.196	48.1	0.355	-96.6
2000	0.487	146.4	1.493	36.6	0.215	47.4	0.367	-102.1

V_{CE}=2V, I_C=10mA, Z_O=50Ω

Freq(MHz)	S ₁₁	∠S ₁₁	S ₂₁	∠S ₂₁	S ₁₂	∠S ₁₂	S ₂₂	∠S ₂₂
100	0.683	-65.5	19.214	137.7	0.038	60.9	0.767	-38.0
200	0.550	-109.9	13.370	114.8	0.055	51.2	0.536	-55.8
400	0.440	-143.5	7.287	93.9	0.074	50.3	0.342	-69.5
600	0.443	-162.0	5.046	83.6	0.094	52.5	0.280	-75.8
800	0.457	-174.9	3.900	75.6	0.114	54.1	0.255	-81.6
1000	0.445	172.3	3.214	67.3	0.135	55.0	0.243	-87.7
1200	0.427	166.4	2.681	60.6	0.156	54.5	0.245	-92.6
1400	0.418	162.9	2.309	54.1	0.177	53.7	0.251	-97.6
1600	0.439	160.3	1.987	49.2	0.199	52.5	0.258	-102.6
1800	0.486	149.1	1.850	46.2	0.221	50.6	0.269	-107.7
2000	0.468	137.2	1.745	40.2	0.241	48.2	0.280	-112.9

V_{CE}=2V, I_C=20mA, Z_O=50Ω

Freq(MHz)	S ₁₁	∠S ₁₁	S ₂₁	∠S ₂₁	S ₁₂	∠S ₁₂	S ₂₂	∠S ₂₂
100	0.540	-87.3	24.533	127.8	0.032	58.3	0.646	-49.3
200	0.469	-125.4	14.920	107.9	0.045	55.2	0.411	-67.4
400	0.437	-157.2	8.009	91.0	0.067	59.1	0.256	-81.3
600	0.430	-171.6	5.453	81.5	0.091	61.2	0.210	-89.3
800	0.428	178.4	4.148	74.0	0.116	61.3	0.197	-95.4
1000	0.427	170.3	3.373	67.4	0.140	60.3	0.196	-100.5
1200	0.424	163.2	2.840	61.0	0.164	58.5	0.201	-105.2
1400	0.424	156.9	2.484	55.3	0.189	56.7	0.208	-109.8
1600	0.423	150.0	2.201	50.1	0.212	54.6	0.218	-114.2
1800	0.420	144.2	1.999	44.8	0.236	52.0	0.228	-119.0
2000	0.422	136.2	1.825	39.5	0.257	49.0	0.238	-123.8

V_{CE}=2V, I_C=30mA, Z_O=50Ω

Freq(MHz)	S ₁₁	∠S ₁₁	S ₂₁	∠S ₂₁	S ₁₂	∠S ₁₂	S ₂₂	∠S ₂₂
100	0.487	-101.2	26.240	123.1	0.029	58.4	0.579	-54.7
200	0.446	-136.8	15.309	104.6	0.041	58.0	0.356	-72.3
400	0.435	-163.5	8.071	89.3	0.065	62.9	0.223	-86.1
600	0.437	-176.4	5.488	80.4	0.090	64.2	0.186	-94.2
800	0.433	174.9	4.181	73.3	0.117	63.7	0.178	-100.3
1000	0.435	166.8	3.388	66.7	0.142	62.3	0.180	-105.7
1200	0.433	160.8	2.855	60.5	0.168	60.1	0.187	-110.1
1400	0.427	154.6	2.491	54.8	0.192	57.9	0.195	-114.4
1600	0.432	147.9	2.211	49.7	0.217	55.4	0.205	-118.8
1800	0.428	141.8	2.002	44.3	0.241	52.7	0.217	-123.3
2000	0.430	134.8	1.831	39.4	0.261	49.4	0.227	-127.9

NSVF6001SB6

S Parameters (Common emitter)

V_{CE}=5V, I_C=5mA, Z_O=50Ω

Freq(MHz)	S ₁₁	∠S ₁₁	S ₂₁	∠S ₂₁	S ₁₂	∠S ₁₂	S ₂₂	∠S ₂₂
100	0.822	-42.5	13.211	150.0	0.035	68.2	0.901	-20.9
200	0.684	-77.8	10.639	128.5	0.056	54.8	0.743	-34.0
400	0.516	-116.3	6.681	103.3	0.076	45.3	0.548	-44.9
600	0.481	-140.7	4.776	89.6	0.087	44.9	0.467	-49.9
800	0.477	-157.6	3.714	80.0	0.098	46.3	0.433	-54.2
1000	0.454	-172.9	3.055	71.0	0.110	48.5	0.419	-58.8
1200	0.435	179.1	2.572	63.0	0.124	50.1	0.416	-64.0
1400	0.431	173.9	2.213	56.2	0.138	51.7	0.419	-68.9
1600	0.449	169.6	1.922	50.7	0.154	52.8	0.424	-74.4
1800	0.495	157.8	1.789	46.3	0.171	52.8	0.431	-80.3
2000	0.482	145.3	1.669	39.6	0.188	52.4	0.440	-85.7

V_{CE}=5V, I_C=10mA, Z_O=50Ω

Freq(MHz)	S ₁₁	∠S ₁₁	S ₂₁	∠S ₂₁	S ₁₂	∠S ₁₂	S ₂₂	∠S ₂₂
100	0.690	-57.0	20.017	141.0	0.031	64.0	0.813	-29.6
200	0.552	-93.8	14.091	118.9	0.046	54.8	0.599	-43.3
400	0.447	-133.6	8.190	97.6	0.064	52.8	0.419	-51.2
600	0.413	-154.2	5.664	86.0	0.080	55.0	0.355	-54.8
800	0.402	-167.0	4.314	77.6	0.098	56.9	0.329	-58.9
1000	0.399	-177.7	3.519	70.1	0.116	57.8	0.320	-63.5
1200	0.395	173.3	2.985	63.3	0.135	57.5	0.322	-68.5
1400	0.390	165.6	2.590	57.2	0.154	57.1	0.325	-73.5
1600	0.396	158.1	2.293	51.4	0.173	56.1	0.332	-78.8
1800	0.398	150.8	2.069	45.7	0.193	54.6	0.341	-84.4
2000	0.396	143.4	1.881	40.4	0.211	52.8	0.350	-90.0

V_{CE}=5V, I_C=30mA, Z_O=50Ω

Freq(MHz)	S ₁₁	∠S ₁₁	S ₂₁	∠S ₂₁	S ₁₂	∠S ₁₂	S ₂₂	∠S ₂₂
100	0.481	-85.7	28.955	127.1	0.024	61.8	0.649	-41.0
200	0.403	-123.6	17.443	107.7	0.035	60.6	0.427	-51.3
400	0.370	-155.2	9.326	91.5	0.056	64.6	0.292	-54.9
600	0.363	-170.7	6.348	82.3	0.078	66.1	0.256	-57.9
800	0.359	179.9	4.826	75.3	0.100	65.9	0.245	-62.2
1000	0.360	171.2	3.907	68.5	0.123	64.8	0.244	-67.4
1200	0.360	164.4	3.288	62.7	0.145	63.1	0.249	-72.7
1400	0.356	157.3	2.871	57.0	0.167	61.2	0.256	-78.0
1600	0.362	151.2	2.541	51.8	0.188	59.0	0.265	-83.6
1800	0.361	143.6	2.290	46.5	0.210	56.5	0.274	-89.4
2000	0.363	137.2	2.076	41.4	0.229	53.6	0.284	-95.1

V_{CE}=5V, I_C=50mA, Z_O=50Ω

Freq(MHz)	S ₁₁	∠S ₁₁	S ₂₁	∠S ₂₁	S ₁₂	∠S ₁₂	S ₂₂	∠S ₂₂
100	0.426	-101.6	29.939	122.4	0.021	62.6	0.587	-42.4
200	0.389	-137.3	17.324	104.3	0.032	63.2	0.385	-49.1
400	0.379	-163.4	9.137	89.5	0.053	67.9	0.277	-50.5
600	0.378	-176.3	6.195	80.8	0.076	68.9	0.252	-53.4
800	0.375	175.0	4.700	74.0	0.098	68.3	0.245	-58.2
1000	0.380	167.8	3.799	67.9	0.121	66.8	0.248	-64.0
1200	0.379	161.2	3.196	61.8	0.143	64.9	0.255	-69.8
1400	0.378	154.9	2.787	56.1	0.165	62.8	0.262	-75.4
1600	0.382	148.6	2.469	50.9	0.187	60.5	0.271	-81.4
1800	0.382	142.5	2.227	45.8	0.209	57.8	0.281	-87.6
2000	0.385	135.6	2.027	40.7	0.228	55.0	0.291	-93.3

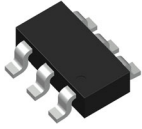

CPH6 2.90x1.60x0.90, 0.95P
CASE 318BD
ISSUE A

DATE 20 SEPT 2024

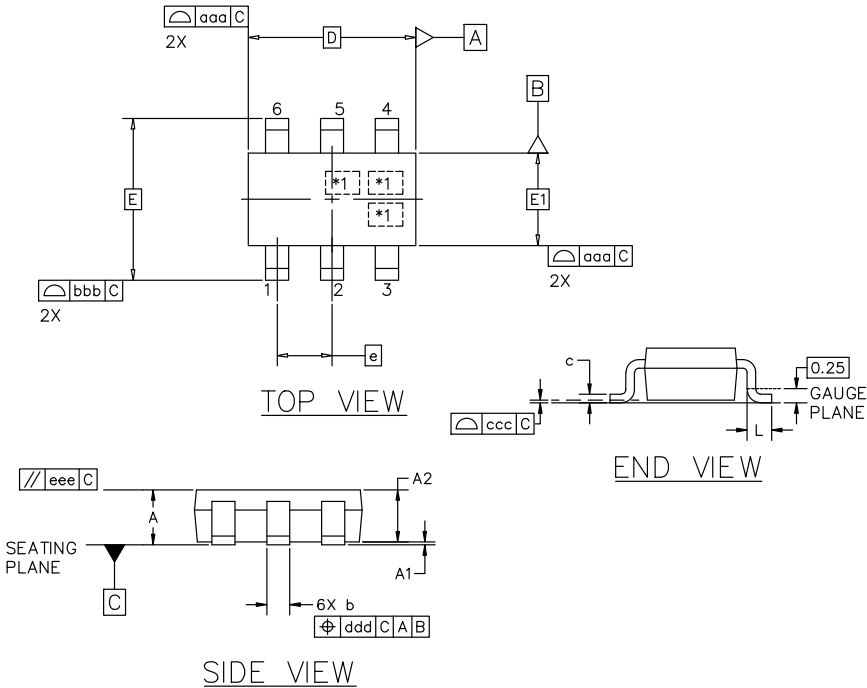

MILLIMETERS			
DIM	MIN	NOM	MAX
A	0.85	0.95	1.05
A1	0.00	0.05	0.10
A2	0.85	0.90	0.95
b	0.30	0.40	0.50
c	0.10	0.15	0.25
D	2.90 BSC		
E	2.80 BSC		
E1	1.60 BSC		
e	0.95 BSC		
L	0.10	0.20	0.30
TOLERANCE FORM AND POSITION			
aaa	0.10		
bbb	0.15		
ccc	0.05		
ddd	0.10		
eee	0.10		

NOTES:

1. DIMENSIONING AND TOLERANCING PER ASME Y14.5M, 2018.
2. CONTROLLING DIMENSION: MILLIMETERS
3. *1 IS FOR LOT INDICATION

GENERIC MARKING DIAGRAM*

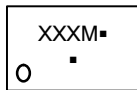

- XXX = Specific Device Code
- M = Date Code
- = Pb-Free Package

(Note: Microdot may be in either location)

*This information is generic. Please refer to device data sheet for actual part marking. Pb-Free indicator, "G" or microdot "▪", may or may not be present. Some products may not follow the Generic Marking.

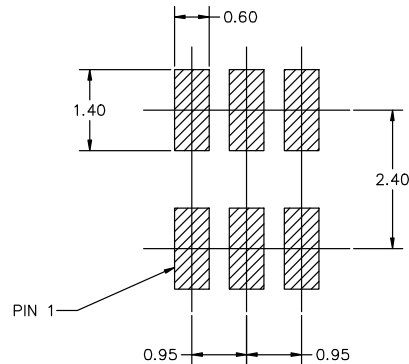

RECOMMENDED MOUNTING FOOTPRINT

* For additional information on our Pb-Free strategy and soldering details, please download the onsemi Soldering and Mounting Techniques Reference Manual, SOLDERRM/D.

DOCUMENT NUMBER:	98AON65440E	Electronic versions are uncontrolled except when accessed directly from the Document Repository. Printed versions are uncontrolled except when stamped "CONTROLLED COPY" in red.
DESCRIPTION:	CPH6 2.90x1.60x0.90, 0.95P	PAGE 1 OF 1

onsemi and ONSEMI are trademarks of Semiconductor Components Industries, LLC dba onsemi or its subsidiaries in the United States and/or other countries. onsemi reserves the right to make changes without further notice to any products herein. onsemi makes no warranty, representation or guarantee regarding the suitability of its products for any particular purpose, nor does onsemi assume any liability arising out of the application or use of any product or circuit, and specifically disclaims any and all liability, including without limitation special, consequential or incidental damages. onsemi does not convey any license under its patent rights nor the rights of others.

onsemi, **Onsemi**, and other names, marks, and brands are registered and/or common law trademarks of Semiconductor Components Industries, LLC dba "**onsemi**" or its affiliates and/or subsidiaries in the United States and/or other countries. **onsemi** owns the rights to a number of patents, trademarks, copyrights, trade secrets, and other intellectual property. A listing of **onsemi**'s product/patent coverage may be accessed at www.onsemi.com/site/pdf/Patent-Marking.pdf. **onsemi** reserves the right to make changes at any time to any products or information herein, without notice. The information herein is provided "as-is" and **onsemi** makes no warranty, representation or guarantee regarding the accuracy of the information, product features, availability, functionality, or suitability of its products for any particular purpose, nor does **onsemi** assume any liability arising out of the application or use of any product or circuit, and specifically disclaims any and all liability, including without limitation special, consequential or incidental damages. Buyer is responsible for its products and applications using **onsemi** products, including compliance with all laws, regulations and safety requirements or standards, regardless of any support or applications information provided by **onsemi**. "Typical" parameters which may be provided in **onsemi** data sheets and/or specifications can and do vary in different applications and actual performance may vary over time. All operating parameters, including "Typicals" must be validated for each customer application by customer's technical experts. **onsemi** does not convey any license under any of its intellectual property rights nor the rights of others. **onsemi** products are not designed, intended, or authorized for use as a critical component in life support systems or any FDA Class 3 medical devices or medical devices with a same or similar classification in a foreign jurisdiction or any devices intended for implantation in the human body. Should Buyer purchase or use **onsemi** products for any such unintended or unauthorized application, Buyer shall indemnify and hold **onsemi** and its officers, employees, subsidiaries, affiliates, and distributors harmless against all claims, costs, damages, and expenses, and reasonable attorney fees arising out of, directly or indirectly, any claim of personal injury or death associated with such unintended or unauthorized use, even if such claim alleges that **onsemi** was negligent regarding the design or manufacture of the part. **onsemi** is an Equal Opportunity/Affirmative Action Employer. This literature is subject to all applicable copyright laws and is not for resale in any manner.

ADDITIONAL INFORMATION

TECHNICAL PUBLICATIONS:

Technical Library: www.onsemi.com/design/resources/technical-documentation
onsemi Website: www.onsemi.com

ONLINE SUPPORT: www.onsemi.com/support

For additional information, please contact your local Sales Representative at www.onsemi.com/support/sales

Mouser Electronics

Authorized Distributor

Click to View Pricing, Inventory, Delivery & Lifecycle Information:

[onsemi:](#)

[NSVF6001SB6T1G](#)