

NC7SZ125

TinyLogic UHS Buffer with Three-State Output

Description

The NC7SZ125 is a single buffer with three-state output from ON Semiconductor's Ultra-High Speed (UHS) of TinyLogic. The device is fabricated with advanced CMOS technology to achieve ultra high speed with high output drive while maintaining low static power dissipation over a very broad V_{CC} operating range. The device is specified to operate over the 1.65 V to 5.5 V range. The inputs and output are high impedance above ground when V_{CC} is 0 V. Inputs tolerate voltages up to 5.5 V independent of V_{CC} operating voltage. The output tolerates voltages above V_{CC} when in the 3-STATE condition.

Features

- Ultra-High Speed: t_{PD} 2.6 ns (Typical) into 50 pF at 5 V V_{CC}
- High Output Drive: ± 24 mA at 3 V V_{CC}
- Broad V_{CC} Operating Range: 1.65 V to 5.5 V
- Matches Performance of LCX when Operated at 3.3 V V_{CC}
- Power Down High-Impedance Inputs / Outputs
- Over-Voltage Tolerance Inputs Facilitate 5 V to 3 V Translation
- Proprietary Noise / EMI Reduction Circuitry
- Ultra-Small MicroPak™ Packages
- Space-Saving SC-74A and SC-88A Packages
- These Devices are Pb-Free, Halogen Free/BFR Free and are RoHS Compliant

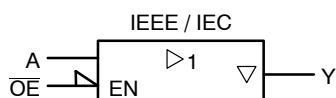

Figure 1. Logic Symbol



ON Semiconductor®

www.onsemi.com

MARKING DIAGRAMS



SIP6
CASE 127EB

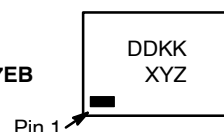

UDFN6
CASE 517DP

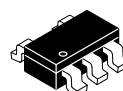
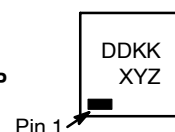

SC-74A
CASE 318BQ

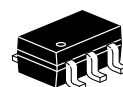
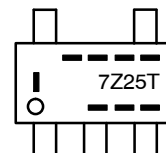

SC-88A
CASE 419AC-01

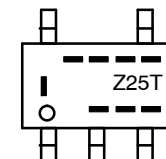

DD, 7Z25, Z25 = Specific Device Code
 KK = 2-Digit Lot Run Traceability Code
 XY = 2-Digit Date Code Format
 Z = Assembly Plant Code
 T = Die Run Code
 --- = Year Coding Scheme
 |--- = Plant Code Identifier
 --- = Eight-Week Datacoding Scheme

ORDERING INFORMATION

See detailed ordering, marking and shipping information in the package dimensions section on page 6 of this data sheet.

NC7SZ125

Pin Configurations

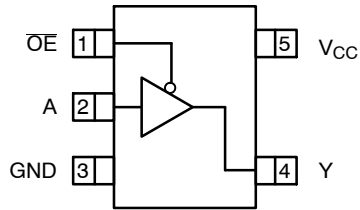

Figure 2. SC-88A and SC-74A (Top View)

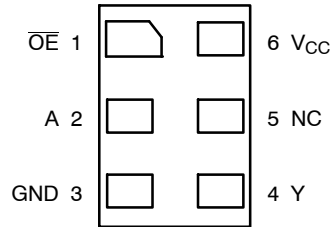

Figure 3. MicroPak (Top Through View)

PIN DEFINITIONS

Pin # SC-88A / SC74A	Pin # MicroPak	Name	Description
1	1	OE	Input
2	2	A	Input
3	3	GND	Ground
4	4	Y	Output
5	6	V _{CC}	Supply Voltage
	5	NC	No Connect

FUNCTION TABLE

Inputs		Output
/OE	In A	Out Y
L	L	L
L	H	H
H	X	Z

H = HIGH Logic Level
 L = LOW Logic Level
 X = HIGH or LOW Logic Level
 Z = HIGH Impedance State

NC7SZ125

ABSOLUTE MAXIMUM RATINGS

Symbol	Parameter	Min	Max	Unit	
V _{CC}	Supply Voltage	-0.5	6.0	V	
V _{IN}	DC Input Voltage	-0.5	6.0	V	
V _{OUT}	DC Output Voltage	-0.5	6.0	V	
I _{IK}	DC Input Diode Current	V _{IN} < -0.5 V	-	-50	mA
		V _{IN} > 6.0 V	-	+20	
I _{OK}	DC Output Diode Current	V _{OUT} < -0.5 V	-	-50	mA
		V _{OUT} > 6 V, V _{CC} = GND	-	+20	
I _{OUT}	DC Output Current	-	±50	mA	
I _{CC} or I _{GND}	DC V _{CC} or Ground Current	-	±50	mA	
T _{STG}	Storage Temperature Range	-65	+150	°C	
T _J	Junction Temperature Under Bias	-	+150	°C	
T _L	Junction Lead Temperature (Soldering, 10 Seconds)	-	+260	°C	
P _D	Power Dissipation in Still Air	SC-74A	-	225	mW
		SC-88A-5	-	190	
		MicroPak-6	-	327	
		MicroPak2™-6	-	327	
ESD	Human Body Model, JEDEC: JESD22-A114	-	4000	V	
	Charge Device Model, JEDEC: JESD22-C101	-	2000		

Stresses exceeding those listed in the Maximum Ratings table may damage the device. If any of these limits are exceeded, device functionality should not be assumed, damage may occur and reliability may be affected.

RECOMMENDED OPERATING CONDITIONS

Symbol	Parameter	Conditions	Min	Max	Unit
V _{CC}	Supply Voltage Operating		1.65	5.50	V
	Supply Voltage Data Retention		1.50	5.50	
V _{IN}	Input Voltage		0	5.5	V
V _{OUT}	Output Voltage	Active State	0	V _{CC}	V
		Three-State	0	5.5	
T _A	Operating Temperature		-40	+85	°C
t _r , t _f	Input Rise and Fall Times	V _{CC} at 1.8 V, 2.5 V ±0.2 V	0	20	ns/V
		V _{CC} at 3.3 V ±0.3 V	0	10	
		V _{CC} at 5.0 V ±0.5 V	0	5	
θ _{JA}	Thermal Resistance	SC-74A	-	555	°C/W
		SC-88A-5	-	659	
		MicroPak-6	-	382	
		MicroPak2-6	-	382	

Functional operation above the stresses listed in the Recommended Operating Ranges is not implied. Extended exposure to stresses beyond the Recommended Operating Ranges limits may affect device reliability.

1. Unused inputs must be held HIGH or LOW. They may not float.

NC7SZ125

DC ELECTRICAL CHARACTERISTICS

Symbol	Parameter	V _{CC} (V)	Conditions	T _A = +25°C			T _A = -40 to +85°C		Unit	
				Min	Typ	Max	Min	Max		
V _{IH}	HIGH Level Input Voltage	1.65 to 1.95		0.65 V _{CC}	-	-	0.65 V _{CC}	-	V	
		2.30 to 5.50		0.70 V _{CC}	-	-	0.70 V _{CC}	-		
V _{IL}	LOW Level Input Voltage	1.65 to 1.95		-	-	0.35 V _{CC}	-	0.35 V _{CC}	V	
		2.30 to 5.50		-	-	0.30 V _{CC}	-	0.30 V _{CC}		
V _{OH}	HIGH Level Output Voltage	1.65	V _{IN} = V _{IH} , I _{OH} = -100 μA	1.55	1.65	-	1.55	-	V	
		1.80		1.70	1.80	-	1.70	-		
		2.30		2.20	2.30	-	2.20	-		
		3.00		2.90	3.00	-	2.90	-		
		4.50		4.40	4.50	-	4.40	-		
		1.65	I _{OH} = -4 mA	1.29	1.52	-	1.29	-		
		2.30		I _{OH} = -8 mA	1.90	2.15	-	1.90		-
		3.00		I _{OH} = -16 mA	2.40	2.80	-	2.40		-
		3.00		I _{OH} = -24 mA	2.30	2.68	-	2.30		-
		4.50		I _{OH} = -32 mA	3.80	4.20	-	3.80		-
V _{OL}	LOW Level Output Voltage	1.65	V _{IN} = V _{IL} , I _{OL} = 100 μA	-	0.00	0.10	-	0.00	V	
		1.80		-	0.00	0.10	-	0.10		
		2.30		-	0.00	0.10	-	0.10		
		3.00		-	0.00	0.10	-	0.10		
		4.50		-	0.00	0.10	-	0.10		
		1.65	I _{OL} = 4 mA	-	0.80	0.24	-	0.24		
		2.30		I _{OL} = 8 mA	-	0.10	0.30	-		0.30
		3.00		I _{OL} = 16 mA	-	0.15	0.40	-		0.40
		3.00		I _{OL} = 24 mA	-	0.22	0.55	-		0.55
		4.50		I _{OL} = 32 mA	-	0.22	0.55	-		0.55
I _{IN}	Input Leakage Current	1.65 to 5.5	0 ≥ V _{IN} ≥ 5.5 V	-	-	±1	-	±10	μA	
I _{OZ}	3-STATE Output Leakage	0 to 5.5	V _{IN} = V _{IH} or V _{IL} 0 ≥ V _O ≥ 5.5 V	-	-	±1	-	±10	μA	
I _{OFF}	Power Off Leakage Current	0	V _{IN} or V _{OUT} = 5.5 V	-	-	1	-	10	μA	
I _{CC}	Quiescent Supply Current	1.65 to 5.50	V _{IN} = 5.5 V, GND	-	-	2	-	20	μA	

NC7SZ125

AC ELECTRICAL CHARACTERISTICS

Symbol	Parameter	V _{CC} (V)	Conditions	T _A = +25°C			T _A = -40 to +85°C		Unit
				Min	Typ	Max	Min	Max	
t _{PLH} , t _{PHL}	Propagation Delay (Figure 4, 6)	1.65	C _L = 15 pF, R _D = 1 MΩ S ₁ = OPEN	-	6.4	13.2	-	13.8	ns
		1.80		-	5.3	11.0	-	11.5	
		2.50 ±0.20		-	3.4	7.5	-	8.0	
		3.30 ±0.30		-	2.5	5.2	-	5.5	
		5.00 ±0.50		-	2.1	4.5	-	4.8	
		3.30 ±0.30	C _L = 50 pF, R _D = 500 Ω S ₁ = OPEN	-	3.2	5.7	-	6.0	
		5.00 ±0.50		-	2.6	5.0	-	5.3	
t _{PZL} , t _{PZH}	Output Enable Time (Figure 4, 6)	1.65	C _L = 50 pF, R _D = 500 Ω R _U = 500 Ω S ₁ = GND for t _{PZH} S ₁ = V _{IN} for t _{PZL} V _{IN} = 2 · V _{CC}	-	8.4	15.0	-	15.6	ns
		1.80		-	7.0	12.5	-	13.0	
		2.50 ±0.20		-	4.6	8.5	-	9.0	
		3.30 ±0.30		-	3.5	6.2	-	6.5	
		5.00 ±0.50		-	2.8	5.5	-	5.8	
t _{PLZ} , t _{PHZ}	Output Disable Time (Figure 4, 6)	1.65	C _L = 50 pF, R _D = 500 Ω R _U = 500 Ω S ₁ = GND for t _{PHZ} S ₁ = V _{IN} for t _{PLZ} V _{IN} = 2 · V _{CC}	-	6.5	13.2	-	14.5	
		1.80		-	5.4	11.0	-	12.0	
		2.50 ±0.20		-	3.5	8.0	-	8.5	
		3.30 ±0.30		-	2.8	5.7	-	6.0	
		5.00 ±0.50		-	2.1	4.7	-	5.0	
C _{IN}	Input Capacitance	0.00		-	4	-	-	-	pF
C _{OUT}	Output Capacitance	0.00		-	8	-	-	-	
C _{PD}	Power Dissipation Capacitance (Note 2) (Figure 5)	3.30		-	17	-	-	-	pF

2. C_{PD} is defined as the value of the internal equivalent capacitance which is derived from dynamic operating current consumption (I_{CCD}) at no output loading and operating at 50% duty cycle. C_{PD} is related to I_{CCD} dynamic operating current by the expression:
 $I_{CCD} = (C_{PD}) (V_{CC}) (f_{IN}) + (I_{CCstatic})$.

NC7SZ125

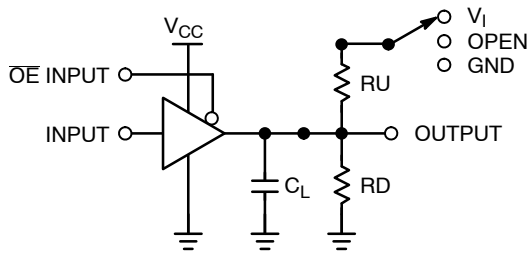

NOTE:
3. C_L includes load and stray capacitance;
Input PRR = 1.0 MHz; t_W = 500 ns

Figure 4. AC Test Circuit

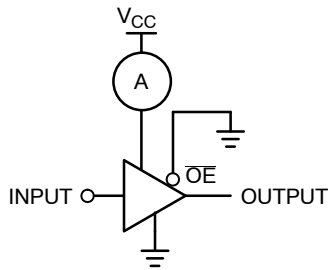

NOTE:
4. Input = AC Waveform; $t_r = t_f = 1.8$ ns;
PRR = 10 MHz; Duty Cycle = 50%.

Figure 5. I_{CCD} Test Circuit

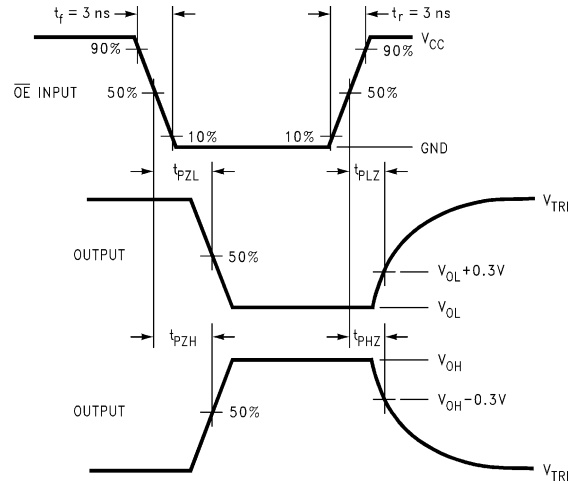
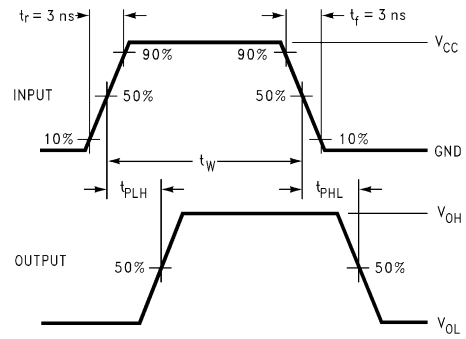

Figure 6. AC Waveforms

ORDERING INFORMATION

Part Number	Top Mark	Operating Temperature	Packages	Shipping†
NC7SZ125M5X	7Z25	-40 to +85°C	SC-74A	3000 / Tape & Reel
NC7SZ125P5X	Z25	-40 to +85°C	SC-88A	3000 / Tape & Reel
NC7SZ125L6X	DD	-40 to +85°C	MicroPak	5000 / Tape & Reel
NC7SZ125FHX	DD	-40 to +85°C	MicroPak2	5000 / Tape & Reel

†For information on tape and reel specifications, including part orientation and tape sizes, please refer to our Tape and Reel Packaging Specifications Brochure, BRD8011/D.

NC7SZ125

PACKAGE DIMENSIONS

SIP6 1.45X1.0
CASE 127EB
ISSUE O

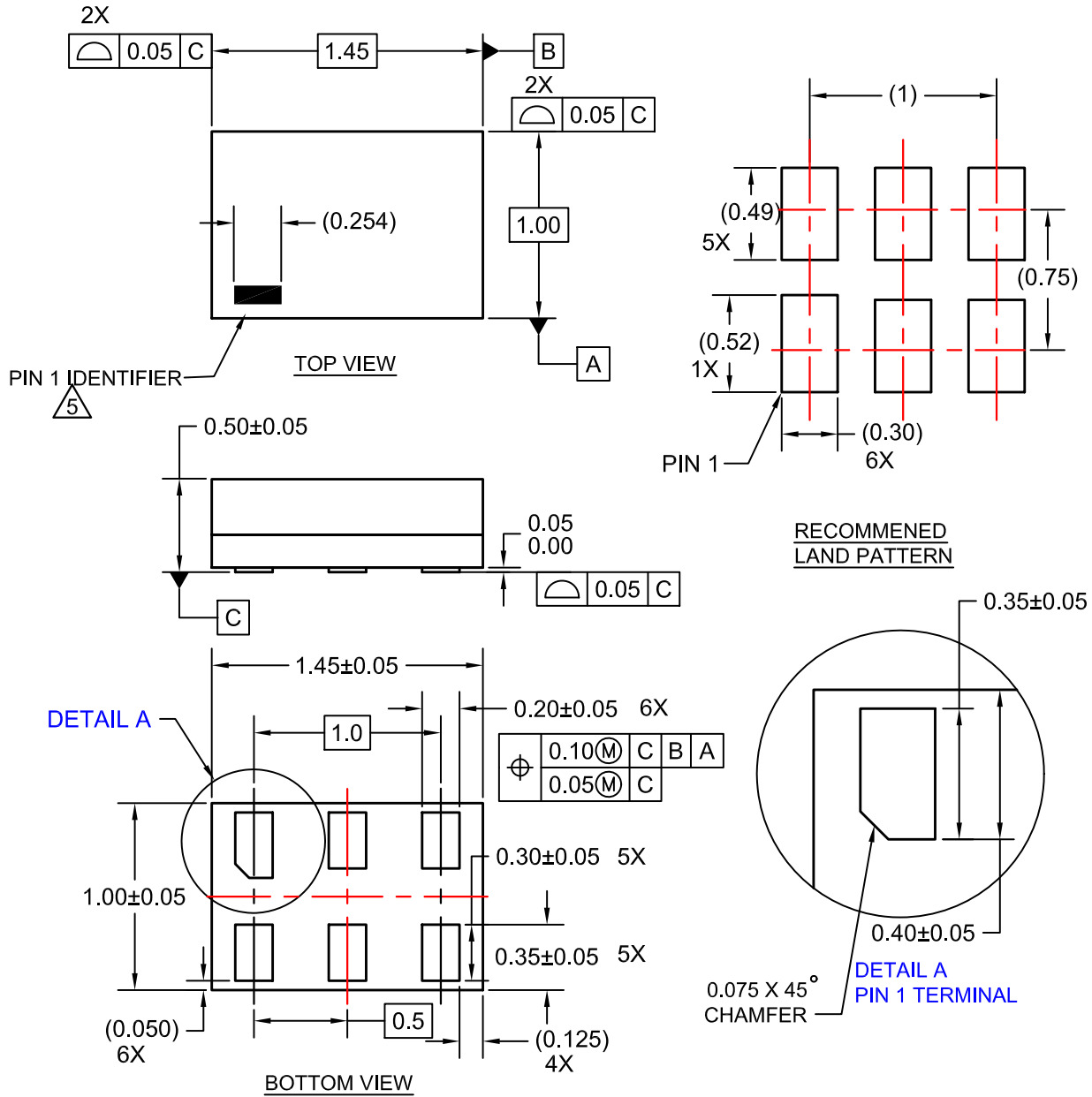

NOTES:

1. CONFORMS TO JEDEC STANDARD MO-252 VARIATION UAAD
2. DIMENSIONS ARE IN MILLIMETERS
3. DRAWING CONFORMS TO ASME Y14.5M-2009
4. PIN ONE IDENTIFIER IS 2X LENGTH OF ANY OTHER LINE IN THE MARK CODE LAYOUT.

NC7SZ125

PACKAGE DIMENSIONS

SC-74A CASE 318BQ ISSUE B

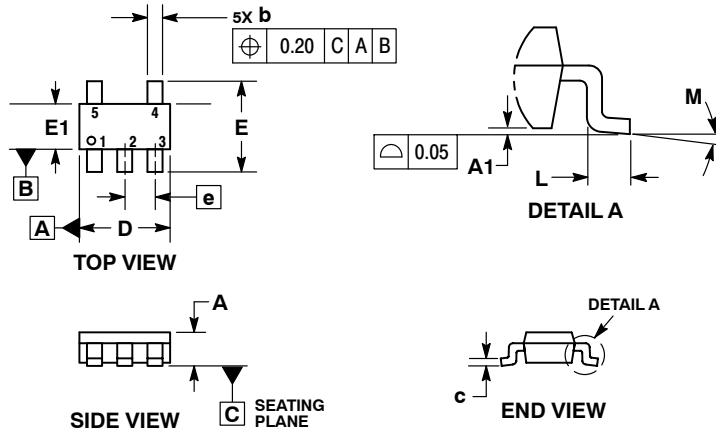

NOTES:

1. DIMENSIONING AND TOLERANCING PER ASME Y14.5M, 1994.
2. CONTROLLING DIMENSION: MILLIMETERS.
3. MAXIMUM LEAD THICKNESS INCLUDES LEAD FINISH THICKNESS. MINIMUM LEAD THICKNESS IS THE MINIMUM THICKNESS OF BASE MATERIAL.
4. DIMENSIONS A AND B DO NOT INCLUDE MOLD FLASH, PROTRUSIONS, OR GATE BURRS. MOLD FLASH, PROTRUSIONS, OR GATE BURRS SHALL NOT EXCEED 0.15 PER SIDE.

DIM	MILLIMETERS	
	MIN	MAX
A	0.90	1.10
A1	0.01	0.10
b	0.25	0.50
c	0.10	0.26
D	2.85	3.15
E	2.50	3.00
E1	1.35	1.65
e	0.95 BSC	
L	0.20	0.60
M	0°	10°

RECOMMENDED SOLDERING FOOTPRINT*

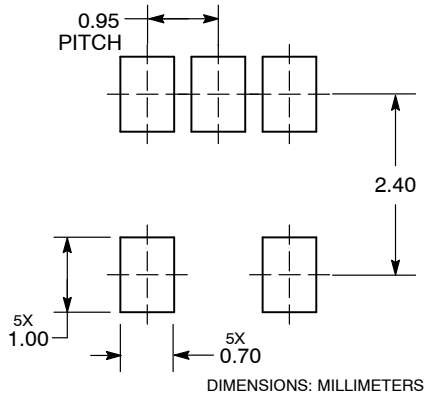

*For additional information on our Pb-Free strategy and soldering details, please download the ON Semiconductor Soldering and Mounting Techniques Reference Manual, SOLDERRM/D.

NC7SZ125

PACKAGE DIMENSIONS

SC-88A (SC-70 5 Lead), 1.25x2
CASE 419AC-01
ISSUE A

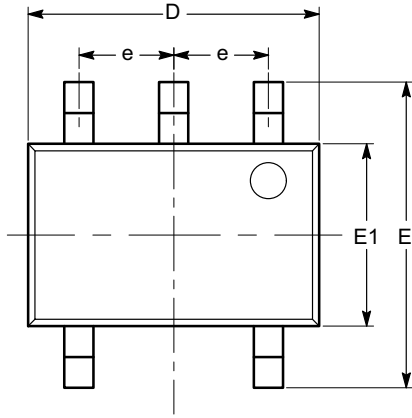

TOP VIEW

SYMBOL	MIN	NOM	MAX
A	0.80		1.10
A1	0.00		0.10
A2	0.80		1.00
b	0.15		0.30
c	0.10		0.18
D	1.80	2.00	2.20
E	1.80	2.10	2.40
E1	1.15	1.25	1.35
e	0.65 BSC		
L	0.26	0.36	0.46
L1	0.42 REF		
L2	0.15 BSC		
θ	0°		8°
$\theta1$	4°		10°

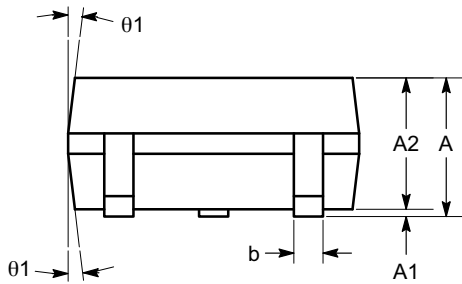

SIDE VIEW

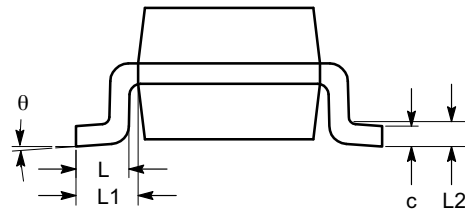

END VIEW

Notes:

- (1) All dimensions are in millimeters. Angles in degrees.
- (2) Complies with JEDEC MO-203.

NC7SZ125

PACKAGE DIMENSIONS

UDFN6 1.0X1.0, 0.35P
CASE 517DP
ISSUE O

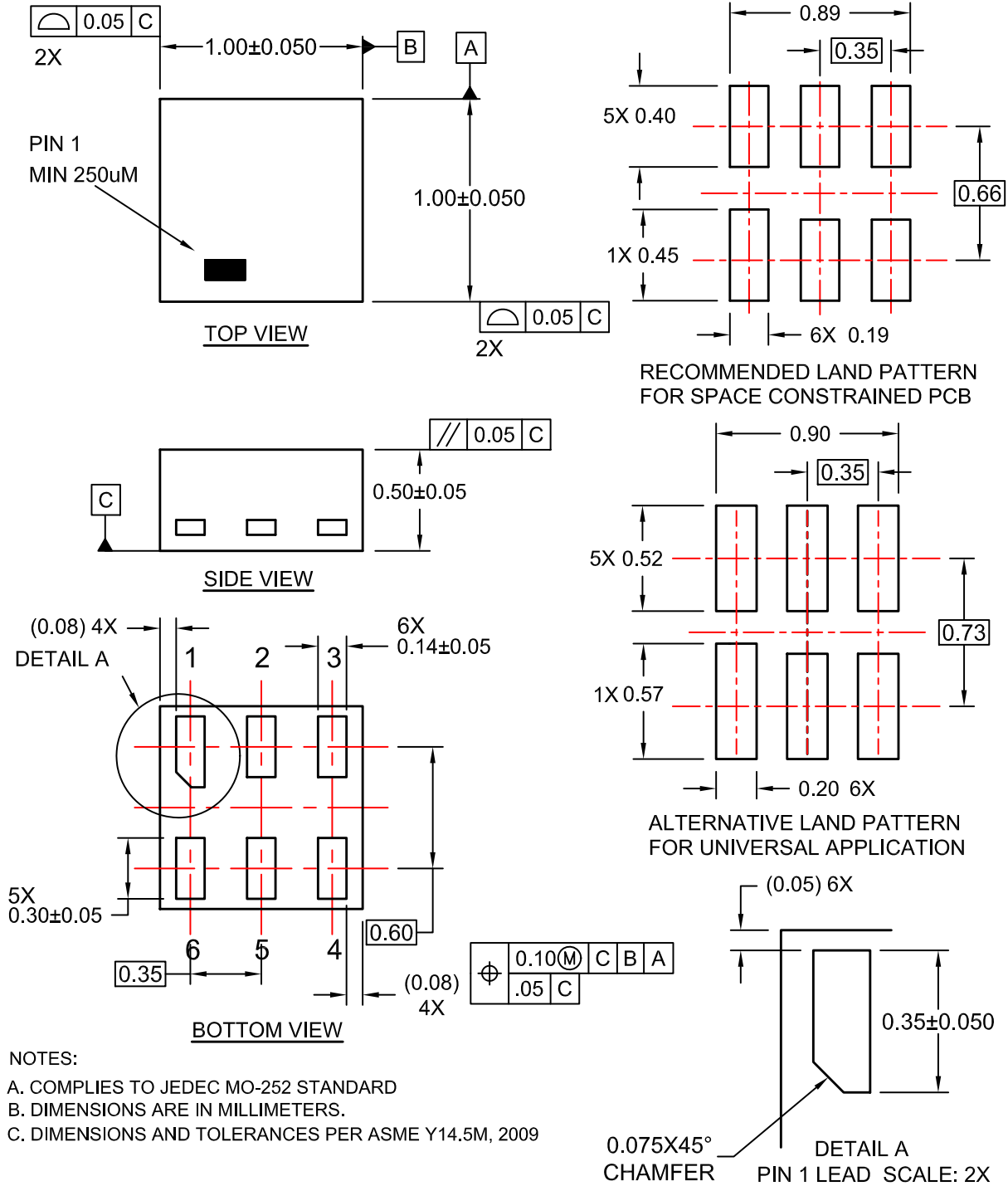

MicroPak and MicroPak2 are trademarks of Semiconductor Components Industries, LLC (SCILLC) or its subsidiaries in the United States and/or other countries.

ON Semiconductor and  are trademarks of Semiconductor Components Industries, LLC dba ON Semiconductor or its subsidiaries in the United States and/or other countries. ON Semiconductor owns the rights to a number of patents, trademarks, copyrights, trade secrets, and other intellectual property. A listing of ON Semiconductor's product/patent coverage may be accessed at www.onsemi.com/site/pdf/Patent-Marking.pdf. ON Semiconductor reserves the right to make changes without further notice to any products herein. ON Semiconductor makes no warranty, representation or guarantee regarding the suitability of its products for any particular purpose, nor does ON Semiconductor assume any liability arising out of the application or use of any product or circuit, and specifically disclaims any and all liability, including without limitation special, consequential or incidental damages. Buyer is responsible for its products and applications using ON Semiconductor products, including compliance with all laws, regulations and safety requirements or standards, regardless of any support or applications information provided by ON Semiconductor. "Typical" parameters which may be provided in ON Semiconductor data sheets and/or specifications can and do vary in different applications and actual performance may vary over time. All operating parameters, including "Typicals" must be validated for each customer application by customer's technical experts. ON Semiconductor does not convey any license under its patent rights nor the rights of others. ON Semiconductor products are not designed, intended, or authorized for use as a critical component in life support systems or any FDA Class 3 medical devices or medical devices with a same or similar classification in a foreign jurisdiction or any devices intended for implantation in the human body. Should Buyer purchase or use ON Semiconductor products for any such unintended or unauthorized application, Buyer shall indemnify and hold ON Semiconductor and its officers, employees, subsidiaries, affiliates, and distributors harmless against all claims, costs, damages, and expenses, and reasonable attorney fees arising out of, directly or indirectly, any claim of personal injury or death associated with such unintended or unauthorized use, even if such claim alleges that ON Semiconductor was negligent regarding the design or manufacture of the part. ON Semiconductor is an Equal Opportunity/Affirmative Action Employer. This literature is subject to all applicable copyright laws and is not for resale in any manner.

PUBLICATION ORDERING INFORMATION

LITERATURE FULFILLMENT:

Literature Distribution Center for ON Semiconductor
19521 E. 32nd Pkwy, Aurora, Colorado 80011 USA
Phone: 303-675-2175 or 800-344-3860 Toll Free USA/Canada
Fax: 303-675-2176 or 800-344-3867 Toll Free USA/Canada
Email: orderlit@onsemi.com

N. American Technical Support: 800-282-9855 Toll Free
USA/Canada
Europe, Middle East and Africa Technical Support:
Phone: 421 33 790 2910

ON Semiconductor Website: www.onsemi.com

Order Literature: <http://www.onsemi.com/orderlit>

For additional information, please contact your local Sales Representative

Mouser Electronics

Authorized Distributor

Click to View Pricing, Inventory, Delivery & Lifecycle Information:

[ON Semiconductor:](#)

[NC7SZ125M5X](#) [NC7SZ125M5](#) [NC7SZ125P5](#) [NC7SZ125P5X](#) [NC7SZ125FHX](#) [NC7SZ125L6X](#)