

HBL1015, HBL1025 Series

LED Shunt

The HBL1015/25 Series are electronic shunts which provide a current bypass in the case of LEDs going into open circuit. LEDs are by nature quite fragile when subjected to transients and surge conditions. There are also many cases where high reliability of the LED lighting must be maintained such as in headlights, lighthouses, bridges, aircraft, runways and so forth. In these cases the low cost addition of the HBL device will provide full assurance that an entire string of LEDs will not extinguish should one LED fail open. The HBL device is also applicable to other loads where circuit continuity is required. The devices can be used with LED string currents from 140 to 500 mA.

Features

- A Bidirectional Device
- Automatically Resets Itself if the LED Heals Itself or is Replaced
- ON-State Voltage Typically 1.8 V
- OFF-State Current less than 0.5 μ A
- These are Pb-Free Devices

Typical Applications

- LEDs where Preventive Maintenance is Impractical
- LED Headlights
- LEDs with High Reliability Requirements
- Crowbar Protection for Open Circuit Conditions
- Overvoltage Protection for Sensitive Circuits

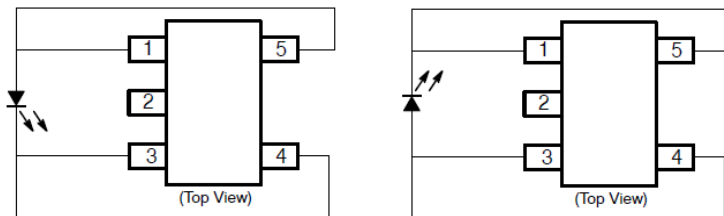

1. Device is bidirectional. Either configuration shown is acceptable.
2. Pin 2 must be electrically floating

Figure 1. Pin Connections



ON Semiconductor®

www.onsemi.com

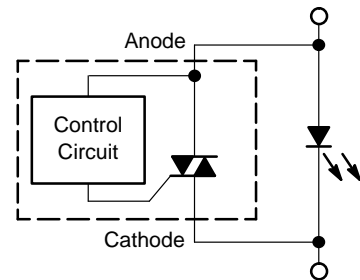

**TSOP-5
CASE 483**

MARKING DIAGRAM

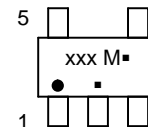

- xxx = Specific Device Code (015 or 025)
M = Date Code
▪ = Pb-Free Package

(Note: Microdot may be in either location)

ORDERING INFORMATION

See detailed ordering and shipping information in the package dimensions section on page 4 of this data sheet.

HBL1015, HBL1025 Series

MAXIMUM RATINGS

Rating	Symbol	Value	Unit
On-State Current, ($T_A = 25^\circ\text{C}$) (Note 1) (Note 2) (Note 3)	$I_{T(AVG)}$	500 425 250	mA
Thermal Resistance, Junction-to-Air (Note 1) (Note 2) (Note 3)	θ_{JA}	140 150 255	$^\circ\text{C/W}$
Operating Temperature Range	T_J	-40 to 150	$^\circ\text{C}$
Non-Operating Temperature Range	T_J	150	$^\circ\text{C}$
Lead Temperature, Soldering (10 Sec)	T_L	260	$^\circ\text{C}$

Stresses exceeding those listed in the Maximum Ratings table may damage the device. If any of these limits are exceeded, device functionality should not be assumed, damage may occur and reliability may be affected.

1. Mounted onto a 1500 mm², Denka K1, 1.5 mm Al, 2 kV thermally conductive dielectric, 2 oz. Cu, or equivalent board. Heat sinking should be spread equally among all pins (caution: pin 2 must be electrically isolated).
2. Mounted onto a 2-layer, 1000 mm² per layer, 3 oz Cu, FR4 PCB. Heat sinking should be spread equally among all pins (caution: pin 2 must be electrically isolated).
3. Mounted onto a 2-layer, 50 mm² per layer, 1 oz Cu, FR4 PCB. Heat sinking should be spread equally among all pins (caution: pin 2 must be electrically isolated).

NOTE: Normally this device would be mounted on the same copper heat sink and adjacent to the LED(s). If the LED(s) were to go open, then the HBL shunt would now dissipate the power using the same copper heat sink. Since the HBL has a voltage that is lower than that of the LED(s), then the power dissipation would be easily handled by the same heat sink as the LED.

ELECTRICAL CHARACTERISTICS (Unless otherwise noted: $T_A = 25^\circ\text{C}$)

Symbol	Characteristics	Min	Min	Typ	Max	Unit
$V_{(BR)}$	Breakdown Voltage: The minimum voltage across the device in or at the breakdown region. Measured at $I_{BR} = 1$ mA.	HBL1015	8.0			V
		HBL1025	11.5			
I_H	Holding Current: The minimum current required to maintain the device in the on-state.	HBL1015			125	mA
		HBL1025			125	
V_{BO}	Breakover Voltage: The voltage across the device in the breakover region. Measured at $I_{BO} = 10$ mA.	HBL1015			14.0	V
		HBL1025			16.0	
I_R	Off-State Current: The dc value of current that results from the application of the off-state voltage. This is measured at 8.0 V for HBL1015 and 11.5 V for HBL1025.	HBL1015			0.5	μA
		HBL1025			0.5	
V_T	On-State Voltage	HBL1015	1.2	1.8	2.4	V
		HBL1025	1.2	1.8	2.4	

Product parametric performance is indicated in the Electrical Characteristics for the listed test conditions, unless otherwise noted. Product performance may not be indicated by the Electrical Characteristics if operated under different conditions.

HBL1015, HBL1025 Series

TYPICAL PERFORMANCE CURVES

($T_A = 25^\circ\text{C}$ unless otherwise noted)

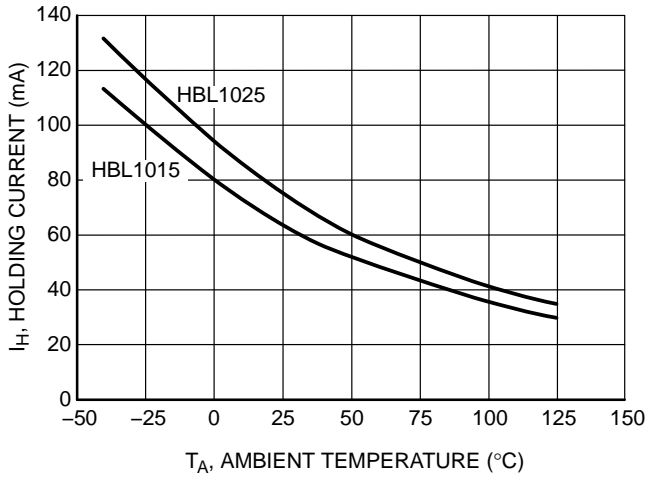

Figure 2. Holding Current vs Temperature

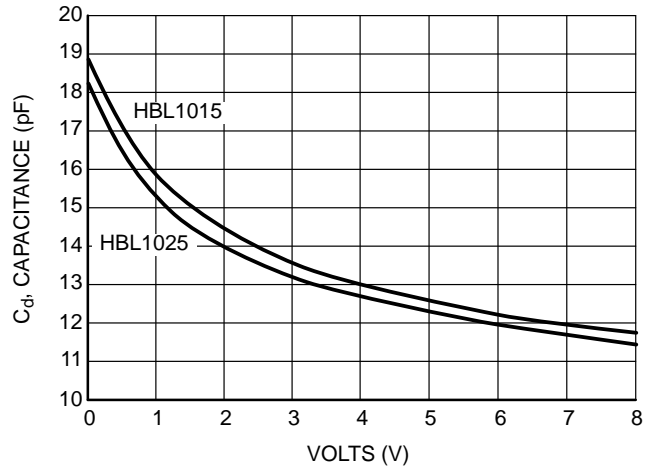

Figure 3. Capacitance vs Voltage

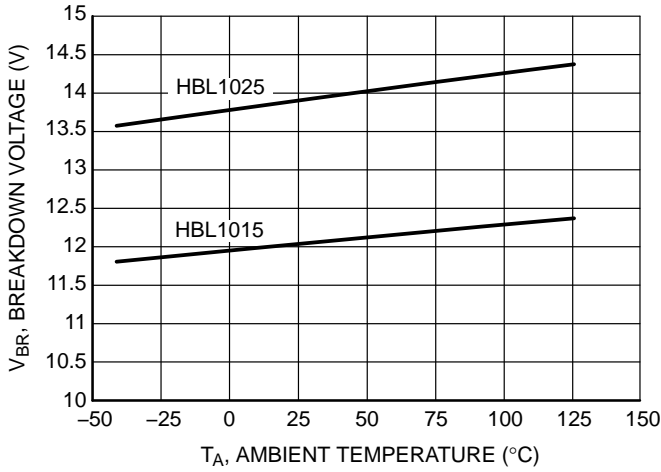

Figure 4. Breakover Voltage vs Temperature

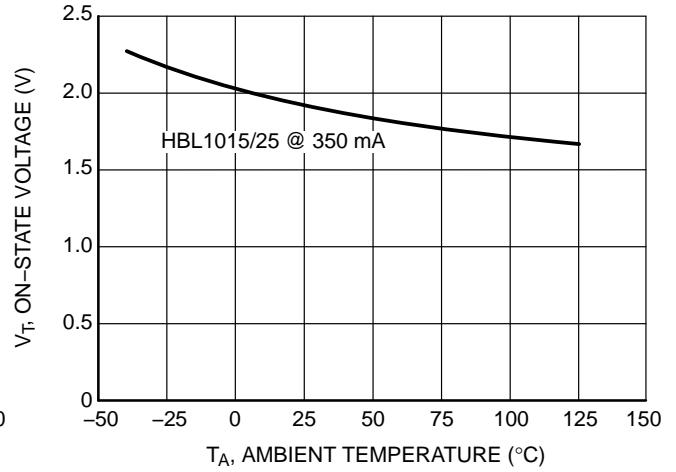

Figure 5. On-State Voltage vs Temperature

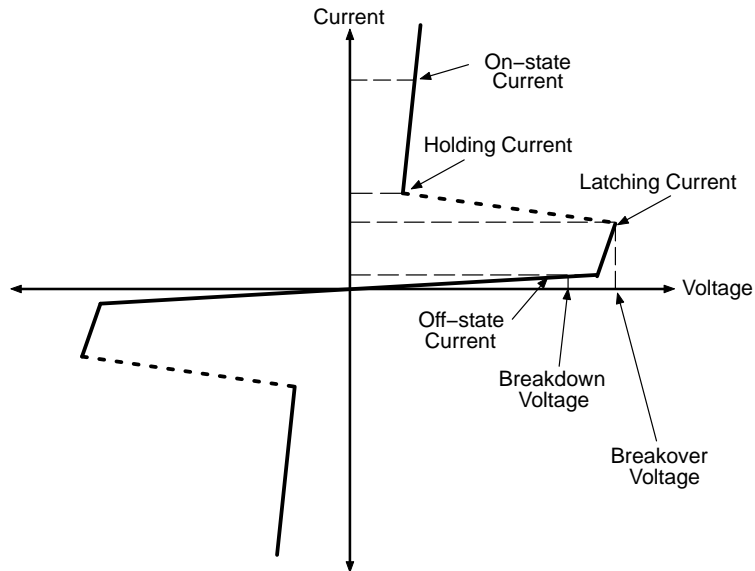
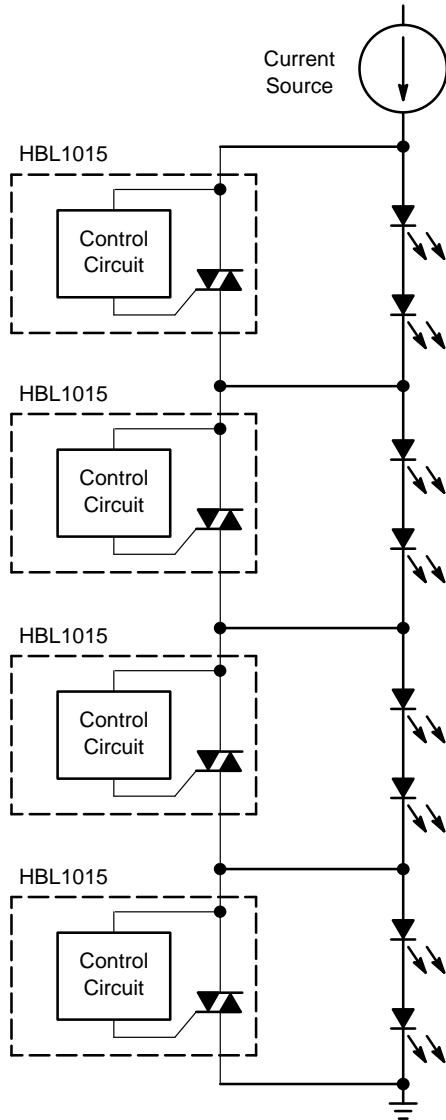

Figure 6. I-V Characteristics

HBL1015, HBL1025 Series

TYPICAL APPLICATION CIRCUIT

Typical Application Circuit for HBL1015



Typical Application Circuit for HBL1025

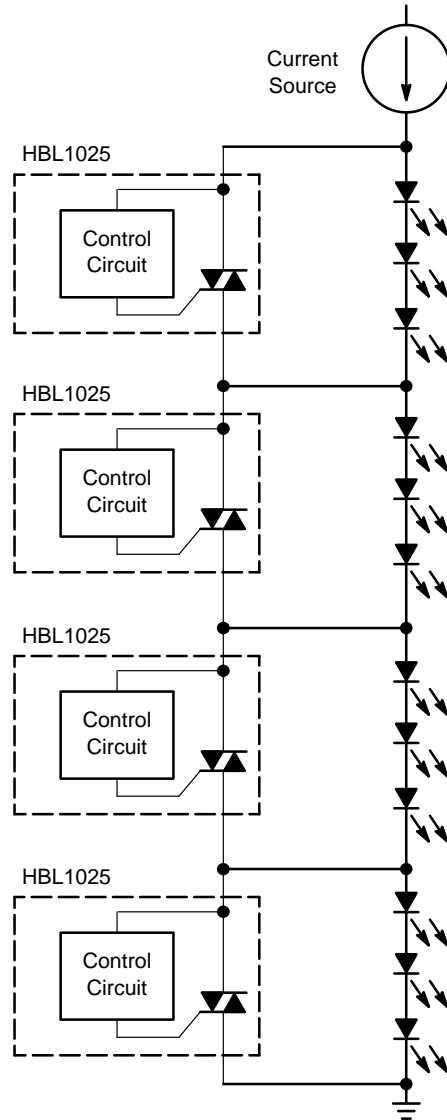

Figure 7. Typical Application Circuit

DEVICE ORDERING INFORMATION

Device	Marking	Package	Shipping†
HBL1015T1G	015	TSOP-5 (Pb-Free)	3000 / Tape & Reel
HBL1025T1G	025	TSOP-5 (Pb-Free)	3000 / Tape & Reel

†For additional information on our Pb-Free strategy and soldering details, please download the ON Semiconductor Soldering and Mounting Techniques Reference Manual, SOLDERRM/D.

HBL1015, HBL1025 Series

PACKAGE DIMENSIONS

TSOP-5 CASE 483-02 ISSUE K

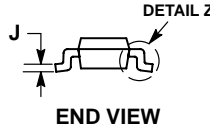
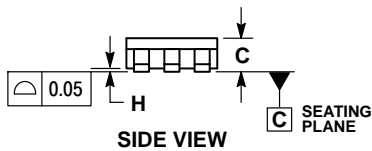
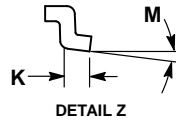
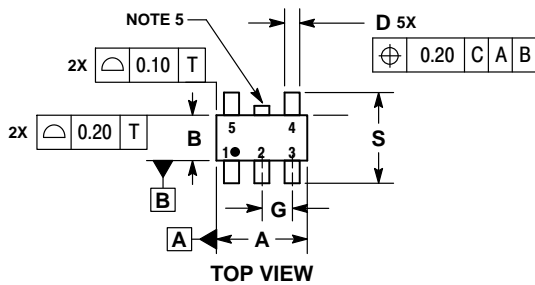

NOTES:

1. DIMENSIONING AND TOLERANCING PER ASME Y14.5M, 1994.
2. CONTROLLING DIMENSION: MILLIMETERS.
3. MAXIMUM LEAD THICKNESS INCLUDES LEAD FINISH THICKNESS. MINIMUM LEAD THICKNESS IS THE MINIMUM THICKNESS OF BASE MATERIAL.
4. DIMENSIONS A AND B DO NOT INCLUDE MOLD FLASH, PROTRUSIONS, OR GATE BURRS. MOLD FLASH, PROTRUSIONS, OR GATE BURRS SHALL NOT EXCEED 0.15 PER SIDE. DIMENSION A.
5. OPTIONAL CONSTRUCTION: AN ADDITIONAL TRIMMED LEAD IS ALLOWED IN THIS LOCATION. TRIMMED LEAD NOT TO EXTEND MORE THAN 0.2 FROM BODY.

DIM	MILLIMETERS	
	MIN	MAX
A	3.00 BSC	
B	1.50 BSC	
C	0.90	1.10
D	0.25	0.50
G	0.95 BSC	
H	0.01	0.10
J	0.10	0.26
K	0.20	0.60
M	0°	10°
S	2.50	3.00

SOLDERING FOOTPRINT*

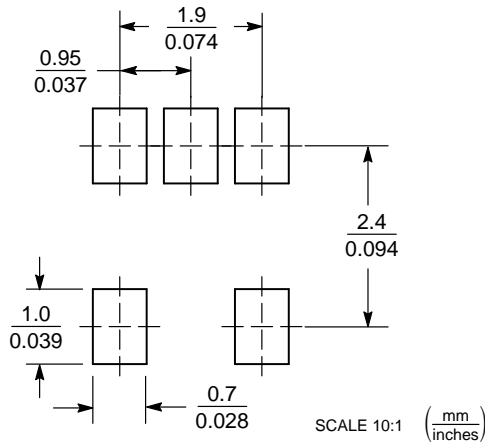

*For additional information on our Pb-Free strategy and soldering details, please download the ON Semiconductor Soldering and Mounting Techniques Reference Manual, SOLDERRM/D.

ON Semiconductor and the  are registered trademarks of Semiconductor Components Industries, LLC (SCILLC) or its subsidiaries in the United States and/or other countries. SCILLC owns the rights to a number of patents, trademarks, copyrights, trade secrets, and other intellectual property. A listing of SCILLC's product/patent coverage may be accessed at www.onsemi.com/site/pdf/Patent-Marking.pdf. SCILLC reserves the right to make changes without further notice to any products herein. SCILLC makes no warranty, representation or guarantee regarding the suitability of its products for any particular purpose, nor does SCILLC assume any liability arising out of the application or use of any product or circuit, and specifically disclaims any and all liability, including without limitation special, consequential or incidental damages. "Typical" parameters which may be provided in SCILLC data sheets and/or specifications can and do vary in different applications and actual performance may vary over time. All operating parameters, including "Typicals" must be validated for each customer application by customer's technical experts. SCILLC does not convey any license under its patent rights nor the rights of others. SCILLC products are not designed, intended, or authorized for use as components in systems intended for surgical implant into the body, or other applications intended to support or sustain life, or for any other application in which the failure of the SCILLC product could create a situation where personal injury or death may occur. Should Buyer purchase or use SCILLC products for any such unintended or unauthorized application, Buyer shall indemnify and hold SCILLC and its officers, employees, subsidiaries, affiliates, and distributors harmless against all claims, costs, damages, and expenses, and reasonable attorney fees arising out of, directly or indirectly, any claim of personal injury or death associated with such unintended or unauthorized use, even if such claim alleges that SCILLC was negligent regarding the design or manufacture of the part. SCILLC is an Equal Opportunity/Affirmative Action Employer. This literature is subject to all applicable copyright laws and is not for resale in any manner.

PUBLICATION ORDERING INFORMATION

LITERATURE FULFILLMENT:

Literature Distribution Center for ON Semiconductor
P.O. Box 5163, Denver, Colorado 80217 USA
Phone: 303-675-2175 or 800-344-3860 Toll Free USA/Canada
Fax: 303-675-2176 or 800-344-3867 Toll Free USA/Canada
Email: orderlit@onsemi.com

N. American Technical Support: 800-282-9855 Toll Free
USA/Canada
Europe, Middle East and Africa Technical Support:
Phone: 421 33 790 2910
Japan Customer Focus Center
Phone: 81-3-5817-1050

ON Semiconductor Website: www.onsemi.com

Order Literature: <http://www.onsemi.com/orderlit>

For additional information, please contact your local Sales Representative

Mouser Electronics

Authorized Distributor

Click to View Pricing, Inventory, Delivery & Lifecycle Information:

[ON Semiconductor:](#)

[HBL1015T1G](#) [HBL1025T1G](#)