



Is Now Part of



ON Semiconductor®

To learn more about ON Semiconductor, please visit our website at
www.onsemi.com

Please note: As part of the Fairchild Semiconductor integration, some of the Fairchild orderable part numbers will need to change in order to meet ON Semiconductor's system requirements. Since the ON Semiconductor product management systems do not have the ability to manage part nomenclature that utilizes an underscore (_), the underscore (_) in the Fairchild part numbers will be changed to a dash (-). This document may contain device numbers with an underscore (_). Please check the ON Semiconductor website to verify the updated device numbers. The most current and up-to-date ordering information can be found at www.onsemi.com. Please email any questions regarding the system integration to Fairchild_questions@onsemi.com.

ON Semiconductor and the ON Semiconductor logo are trademarks of Semiconductor Components Industries, LLC dba ON Semiconductor or its subsidiaries in the United States and/or other countries. ON Semiconductor owns the rights to a number of patents, trademarks, copyrights, trade secrets, and other intellectual property. A listing of ON Semiconductor's product/patent coverage may be accessed at www.onsemi.com/site/pdf/Patent-Marking.pdf. ON Semiconductor reserves the right to make changes without further notice to any products herein. ON Semiconductor makes no warranty, representation or guarantee regarding the suitability of its products for any particular purpose, nor does ON Semiconductor assume any liability arising out of the application or use of any product or circuit, and specifically disclaims any and all liability, including without limitation special, consequential or incidental damages. Buyer is responsible for its products and applications using ON Semiconductor products, including compliance with all laws, regulations and safety requirements or standards, regardless of any support or applications information provided by ON Semiconductor. "Typical" parameters which may be provided in ON Semiconductor data sheets and/or specifications can and do vary in different applications and actual performance may vary over time. All operating parameters, including "Typicals" must be validated for each customer application by customer's technical experts. ON Semiconductor does not convey any license under its patent rights nor the rights of others. ON Semiconductor products are not designed, intended, or authorized for use as a critical component in life support systems or any FDA Class 3 medical devices or medical devices with a same or similar classification in a foreign jurisdiction or any devices intended for implantation in the human body. Should Buyer purchase or use ON Semiconductor products for any such unintended or unauthorized application, Buyer shall indemnify and hold ON Semiconductor and its officers, employees, subsidiaries, affiliates, and distributors harmless against all claims, costs, damages, and expenses, and reasonable attorney fees arising out of, directly or indirectly, any claim of personal injury or death associated with such unintended or unauthorized use, even if such claim alleges that ON Semiconductor was negligent regarding the design or manufacture of the part. ON Semiconductor is an Equal Opportunity/Affirmative Action Employer. This literature is subject to all applicable copyright laws and is not for resale in any manner.



FPF2213-FPF2215

Integrated Load Switch with Adjustable High Precision Current Limit

Features

- 1.8 to 5.5V Input Voltage Range
- Typical $R_{DS(ON)} = 250m\Omega @ V_{IN} = 5.5V$
- Typical $R_{DS(ON)} = 275m\Omega @ V_{IN} = 3.3V$
- 100-250mA (min) Adjustable Current Limit
- 5% Current Limit Tolerance @ 250mA (min)
- 72 Ω (typ) Output Discharge Resistance
- ESD Protected, Above 8000V HBM and 2000V CDM

Applications

- PDAs
- Cell Phones
- GPS Devices
- MP3 Players
- Digital Cameras
- Peripheral Ports
- Notebook Computer

General Description

The FPF2213-FPF2215 are low $R_{DS(ON)}$ P-Channel MOSFET load switches with high precision current limit value. The input voltage range operates from 1.8V to 5.5V to fulfill today's Ultra Portable Device's supply requirement. Switch control is by a logic input (ON) capable of interfacing directly with low voltage control signal. On-chip pull-down is available for output quick discharge when switch is turned off.

For the FPF2214, if the constant current condition still persists after 30ms, these parts will shut off the switch and pull the fault signal pin (FLAGB) low. The FPF2213 has an auto-restart feature, which will turn the switch on again after 450ms if the ON pin is still active. The FPF2214 do not have this auto-restart feature so the switch will remain off until the ON pin is cycled. For the FPF2215, a current limit condition will immediately pull the fault signal pin low and the part will remain in the constant-current mode until the switch current falls below the current limit. For the FPF2213 through FPF2215, the current limit is set by an external resistor and the minimum current limit is 100mA.

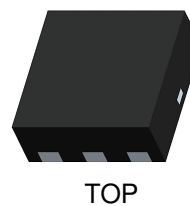
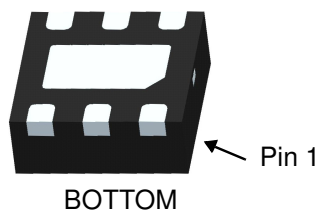

Ordering Information

| Part | Current Limit (mA) | Current Limit Blanking Time (mS) | Auto-Restart Time (mS) | ON Pin Activity |
|---------|--------------------|----------------------------------|------------------------|-----------------|
| FPF2213 | 100-250 | 30 | 450 | Active HI |
| FPF2214 | 100-250 | 30 | NA | Active HI |
| FPF2215 | 100-250 | NA | NA | Active HI |

Typical Application Circuit

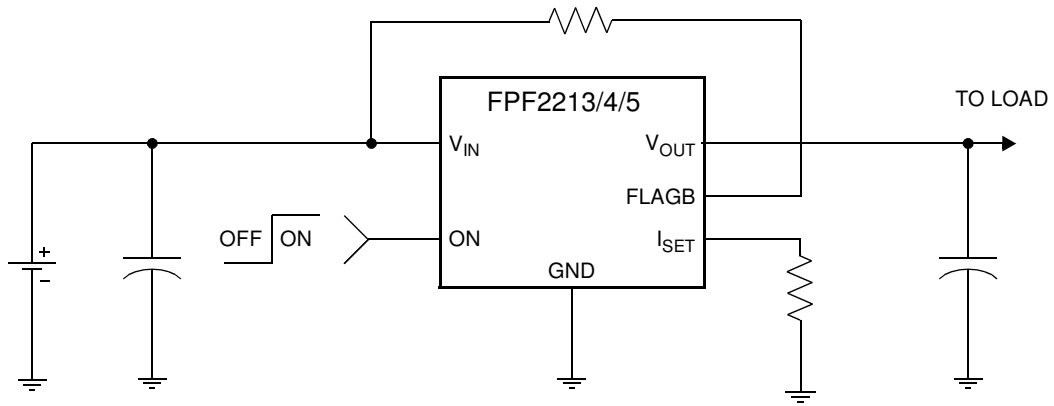

Functional Block Diagram

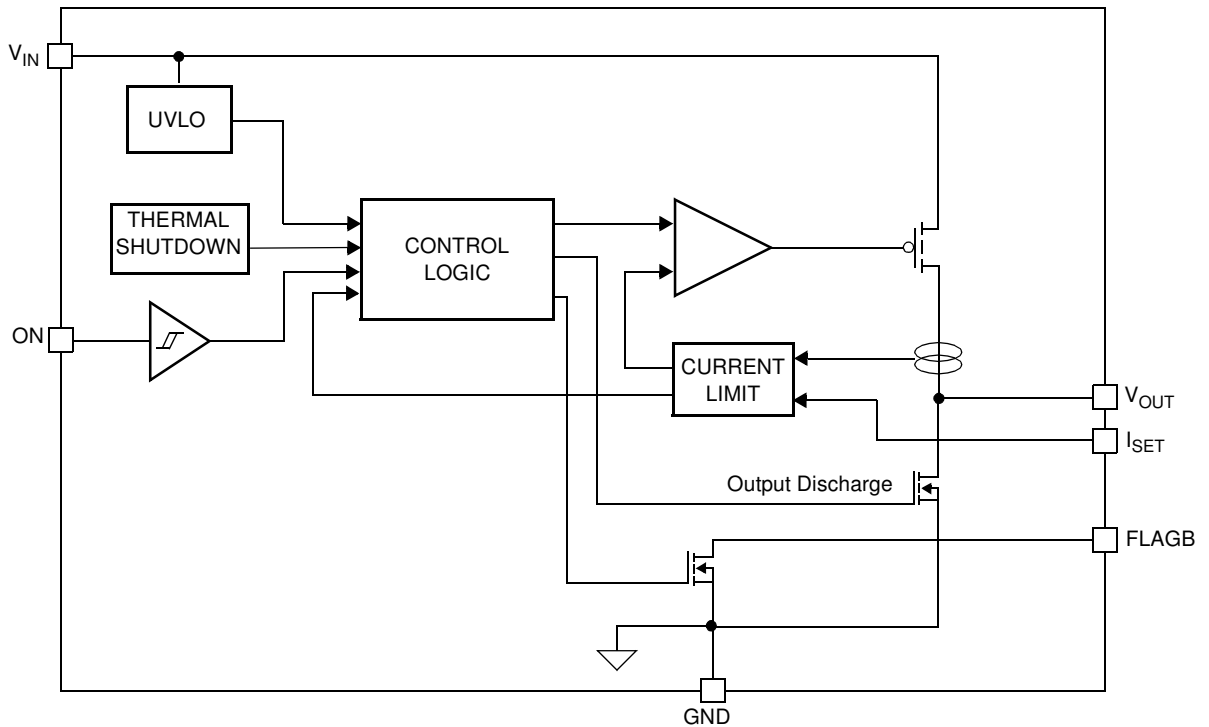

Pin Configuration

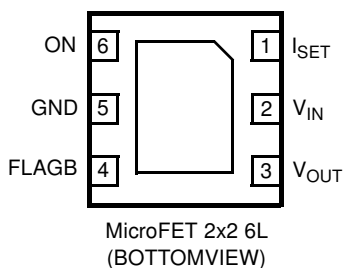

Pin Description

| Pin | Name | Function |
|-----|-----------|--|
| 1 | I_{SET} | Current Limit Set Input : A resistor from I_{SET} to ground sets the current limit for the switch |
| 2 | V_{IN} | Supply Input: Input to the power switch and the supply voltage for the IC |
| 3 | V_{OUT} | Switch Output: Output of the power switch |
| 4 | FLAGB | Fault Output: Active LO, open drain output which indicates an over current, supply under voltage or over temperature state |
| 5 | GND | Ground |
| 6 | ON | ON/OFF Control Input |

Absolute Maximum Ratings

| Parameter | Min. | Max. | Unit |
|--|------|------|---------------------------|
| V_{IN} , V_{OUT} , ON, FLAGB TO GND | -0.3 | 6 | V |
| I_{SET} TO GND | -0.3 | 0.3 | V |
| Power Dissipation @ $T_A = 25^\circ\text{C}$ | | 1.2 | W |
| Operating and Storage Junction Temperature | -65 | 125 | $^\circ\text{C}$ |
| Thermal Resistance, Junction to Ambient | | 86 | $^\circ\text{C}/\text{W}$ |
| Electrostatic Discharge Protection | HBM | 8000 | V |
| | MM | 400 | V |
| | CDM | 2000 | V |

Recommended Operating Range

| Parameter | Min. | Max. | Unit |
|--------------------------------------|------|------|------------------|
| V_{IN} | 1.8 | 5.5 | V |
| Ambient Operating Temperature, T_A | -40 | 85 | $^\circ\text{C}$ |

Electrical Characteristics

$V_{IN} = 1.8$ to 5.5V , $T_A = -40$ to $+85^\circ\text{C}$ unless otherwise noted. Typical values are at $V_{IN} = 3.3\text{V}$ and $T_A = 25^\circ\text{C}$.

| Parameter | Symbol | Conditions | Min. | Typ. | Max. | Units |
|---------------------------|----------|---|------|------|------|---------------|
| Basic Operation | | | | | | |
| Operating Voltage | V_{IN} | | 1.8 | | 5.5 | V |
| Quiescent Current | I_Q | $I_{OUT}=0\text{mA}$, $V_{IN}=V_{ON}=1.8\text{V}$, $R_{SET}=26.8\text{K}$ | | 45 | 75 | μA |
| | | $I_{OUT}=0\text{mA}$, $V_{IN}=V_{ON}=3.3\text{V}$, $R_{SET}=26.8\text{K}$ | | 50 | 85 | |
| | | $I_{OUT}=0\text{mA}$, $V_{IN}=V_{ON}=5.5\text{V}$, $R_{SET}=26.8\text{K}$ | | 60 | 95 | |
| V_{IN} Shutdown Current | | $V_{ON}=0\text{V}$, $V_{IN}=5.5\text{V}$, $V_{OUT}=\text{short to GND}$ | | | 2.5 | μA |

| Parameter | Symbol | Conditions | Min. | Typ. | Max. | Units |
|-----------------------------------|-----------------|--|------|------|------|-------|
| V _{OUT} Shutdown Current | | V _{ON} =0V, V _{OUT} =5.5V, V _{IN} =short to GND | | | 1 | μA |
| On-Resistance | R _{ON} | V _{IN} =5.5V, I _{OUT} =200mA, T _A =25°C | | 250 | 325 | mΩ |
| | | V _{IN} =3.3V, I _{OUT} =200mA, T _A =25°C | | 275 | 360 | |
| | | V _{IN} =1.8V, I _{OUT} =200mA, T _A =25°C | | 350 | 455 | |
| | | V _{IN} =3.3V, I _{OUT} =200mA, T _A =-40 to +80°C | 135 | | 450 | |
| Output Discharge Resistance | | V _{IN} =3.3V, V _{ON} =0V, I _{OUT} =10mA | | 72 | 105 | Ω |
| ON Input Logic High Voltage (ON) | V _{IH} | V _{IN} =1.8V | 0.8 | | | V |
| | | V _{IN} =5.5V | 1.4 | | | |
| ON Input Logic Low Voltage (OFF) | V _{IL} | V _{IN} =1.8V | | | 0.5 | V |
| | | V _{IN} =5.5V | | | 1.0 | |
| On Input Leakage | | V _{ON} = V _{IN} or GND | -1 | | 1 | μA |
| FLAGB Output Logic Low Voltage | | V _{IN} =5.5V, I _{SINK} =100μA | | 0.05 | 0.1 | V |
| | | V _{IN} =1.8V, I _{SINK} =100μA | | 0.12 | 0.25 | |
| FLAGB Output High Leakage Current | | V _{IN} =5.5V, Switch on | | | 1 | μA |

| Protections | | | | | | |
|-----------------------------------|--------------------|---|------|------|------|----|
| Current Limit | I _{LIM} | V _{IN} =3.3V, V _{OUT} = 3.0V, R _{SET} =26.8K, T _A =25°C | 250 | 263 | 276 | mA |
| Thermal Shutdown | | Shutdown Threshold | | 140 | | °C |
| | | Return from Shutdown | | 130 | | |
| | | Hysteresis | | 10 | | |
| Under Voltage Shutdown | UVLO | V _{IN} increasing | 1.55 | 1.65 | 1.75 | V |
| Under Voltage Shutdown Hysteresis | | | | 50 | | mV |
| Dynamic | | | | | | |
| Turn On Time | t _{ON} | R _L =500Ω, C _L =0.001μF | | 70 | | μS |
| Turn Off Time | t _{OFF} | R _L =500Ω, C _L =0.001μF | | 600 | | nS |
| V _{OUT} Rise Time | t _{RISE} | R _L =500Ω, C _L =0.001μF | | 40 | | μS |
| V _{OUT} Fall Time | t _{FALL} | R _L =500Ω, C _L =0.001μF | | 100 | | nS |
| Over Current Blanking Time | t _{BLANK} | FPF2213, FPF2214 | 15 | 30 | 60 | mS |
| Auto-Restart Time | t _{RSTRT} | FPF2213 | 225 | 450 | 900 | mS |
| Current Limit Response Time | | V _{IN} = V _{ON} = 3.3V. Over-Current Condition: R _{LOAD} =V _{IN} /(I _{LIM} ×4) | | 5 | | μS |

Typical Characteristics

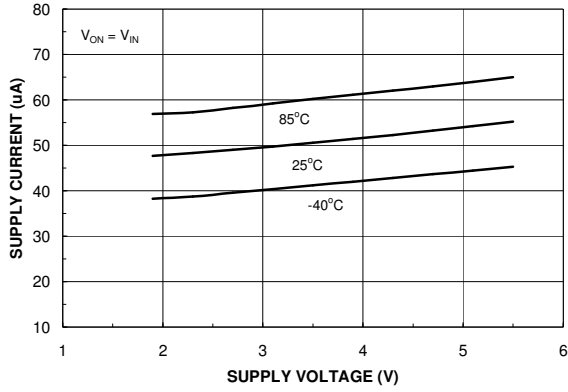

Figure 1. Quiescent Current vs. Input Voltage

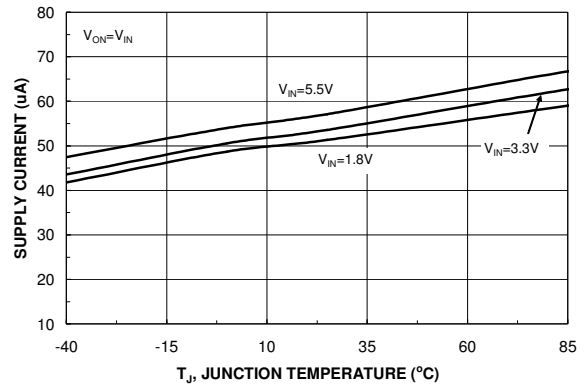

Figure 2. Quiescent Current vs. Temperature

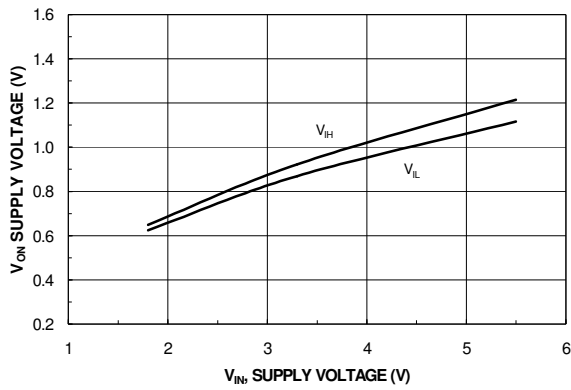

Figure 3. V_{ON} vs. Input Voltage

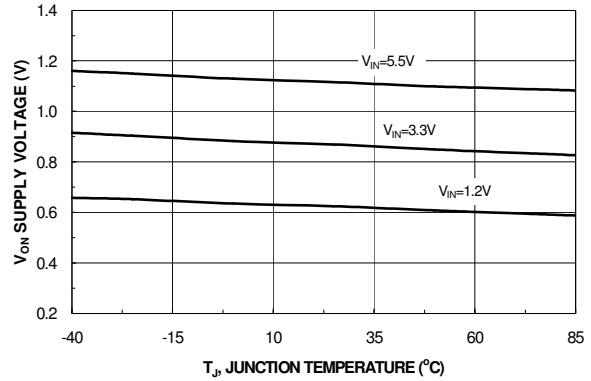

Figure 4. V_{ON} High Voltage vs. Temperature

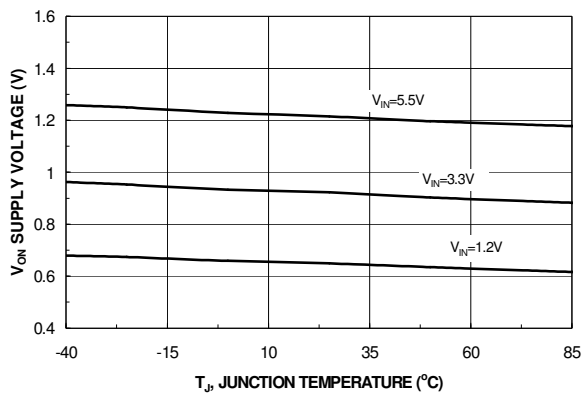

Figure 5. V_{ON} Low Voltage vs. Temperature

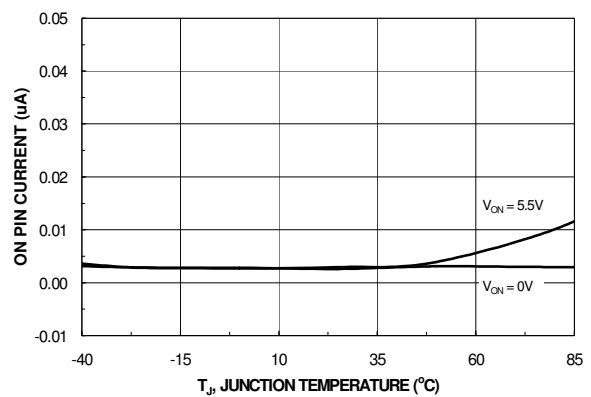

Figure 6. On Pin Current vs. Temperature

Typical Characteristics

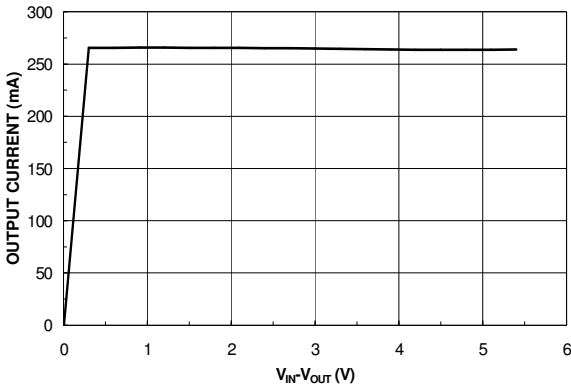

Figure 7. Current Limit vs. Output Voltage

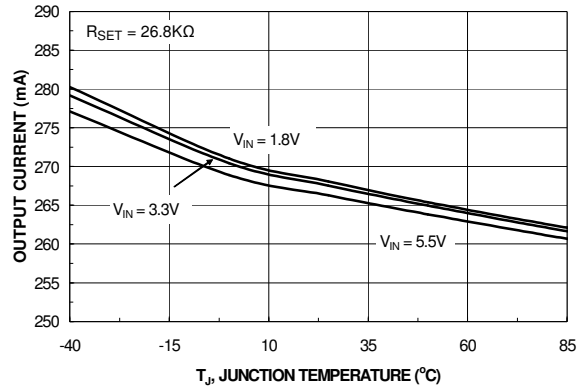

Figure 8. Current Limit vs. Temperature

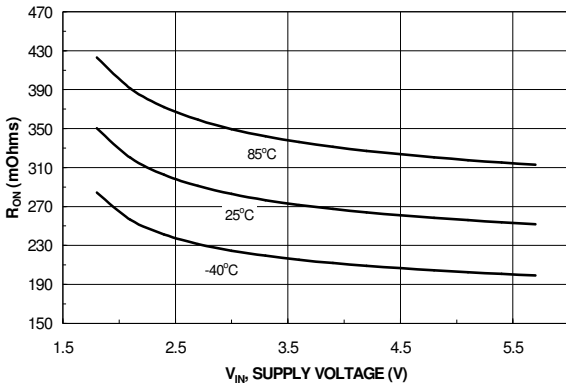

Figure 9. R_{ON} vs. Input Voltage

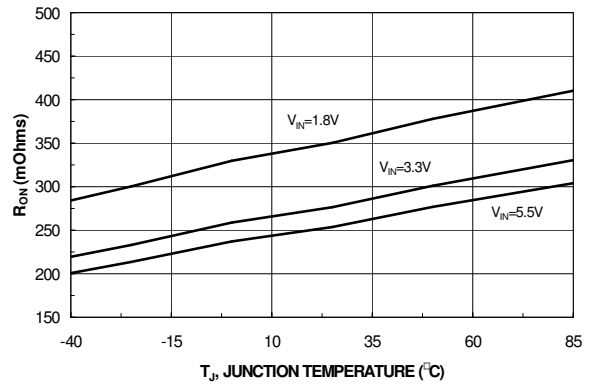

Figure 10. R_{ON} vs. Temperature

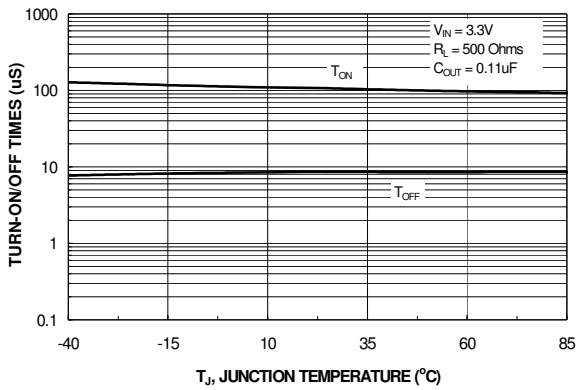

Figure 11. T_{ON} / T_{OFF} vs. Temperature

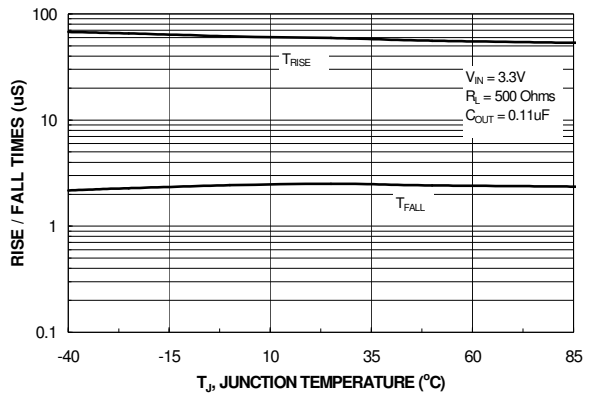

Figure 12. T_{RISE} / T_{FALL} vs. Temperature

Typical Characteristics

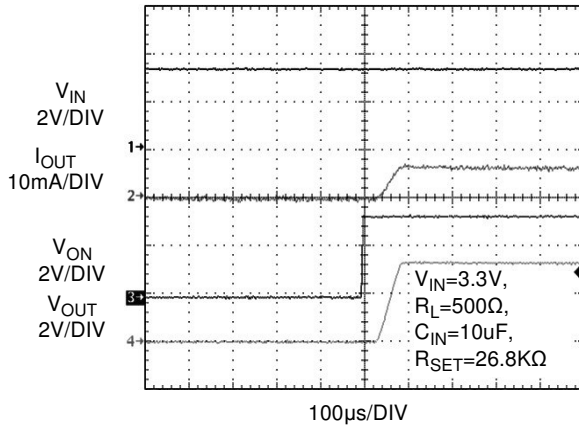

Figure 13. Turn On Response

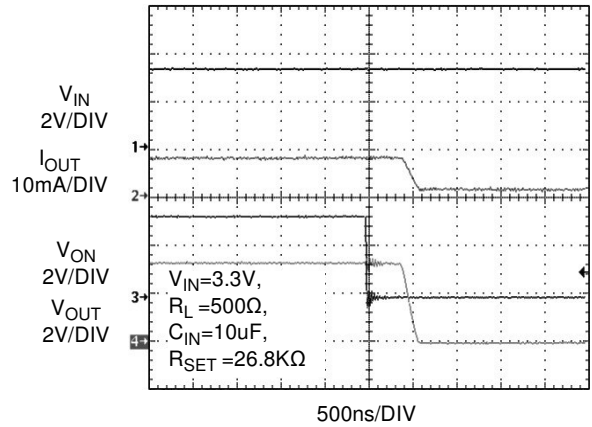

Figure 14. Turn Off Response

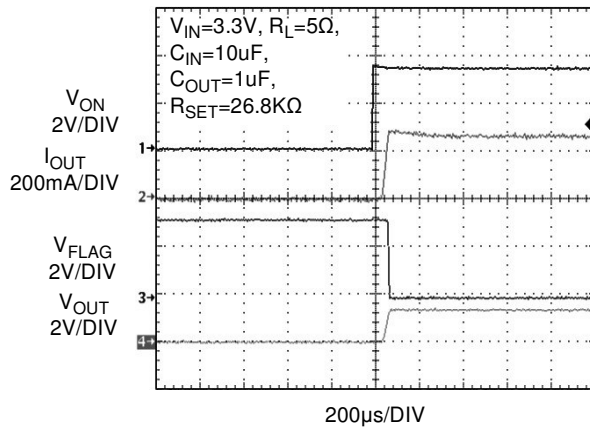

Figure 15. Current Limit Response
(Output is loaded with 5Ω resistor and $C_{OUT}=1\mu F$)

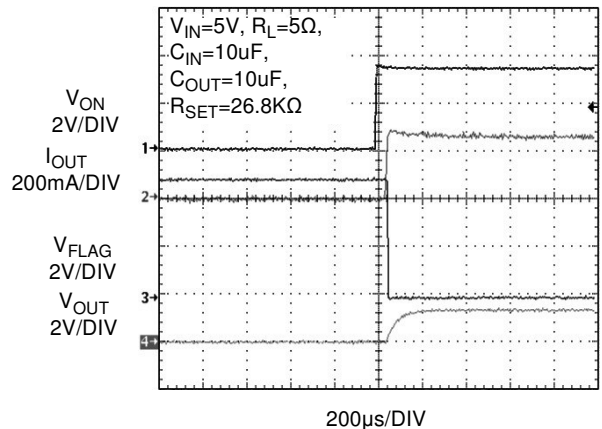

Figure 16. Current Limit Response
(Output is loaded with 5Ω resistor and $C_{OUT}=10\mu F$)

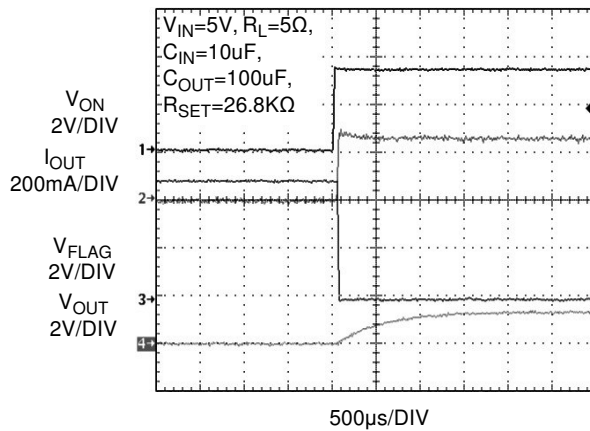

Figure 17. Current Limit Response
(Output is loaded with 5Ω resistor and $C_{OUT}=100\mu F$)

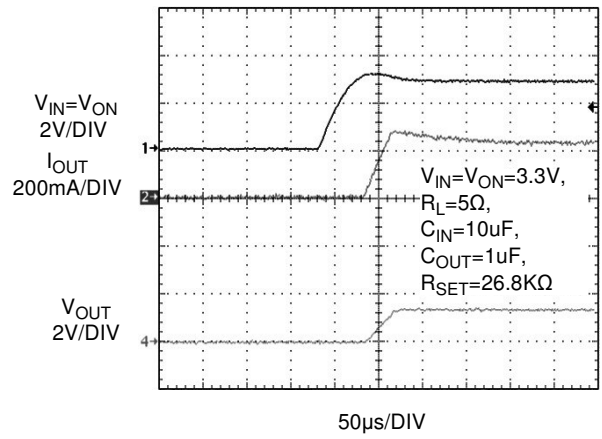

Figure 18. Current Limit Response
(Switch is powered into a short - input and enable pin are tied together)

Typical Characteristics

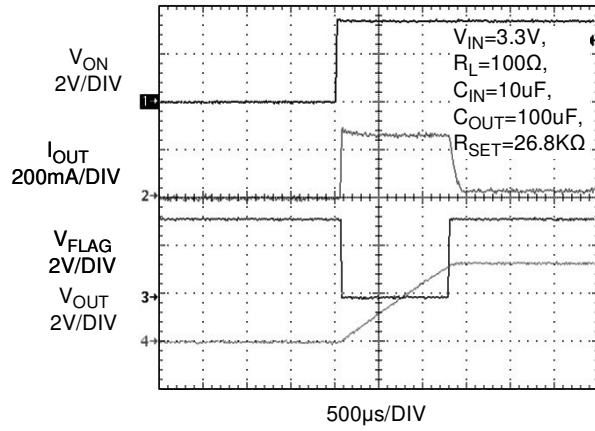

Figure 19. Current Limit Response
(Output is loaded with large capacitor)

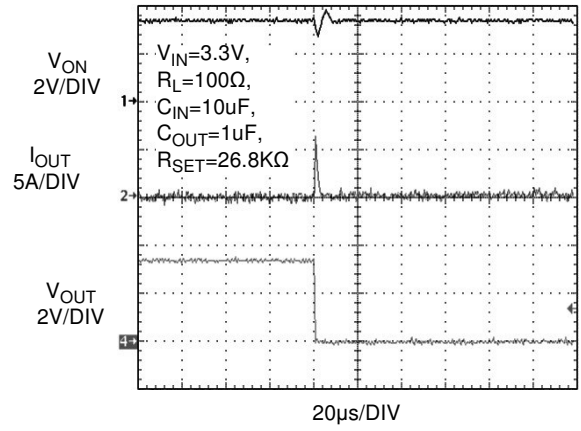

Figure 20. Current Limit Response
(Output shorted to GND while the switch is in normal operation)

Description of Operation

The FPF2213, FPF2214, and FPF2215 are state of the art Adjustable High Precision Current Limit switches that protect systems and loads which can be damaged or disrupted by the application of high currents. The core of each device is a 0.27 Ω P-channel MOSFET and a controller capable of functioning over an input operating range of 1.8V - 5.5V. The controller protects offers current limiting, UVLO(undervoltage lockout) and thermal shutdown protection. The current limit is adjustable from 100mA to 250mA through the selection of an external resistor.

On/Off Control

The ON pin is active high, and controls the state of the switch. Applying a continuous high signal will hold the switch in the on state. The switch will move into the OFF state when the active high is removed, or if a fault is encountered. For all versions, an undervoltage on VIN or a junction temperature in excess of 140°C overrides the ON control to turn off the switch.

In addition, excessive currents will cause the switch to turn off in the FPF2213 and FPF2214. The FPF2213 has an Auto-Restart feature which will automatically turn the switch on again after 450ms. For the FPF2214, the ON pin must be toggled to turn-on the switch again. The FPF2215 does not turn off in response to an over current condition but instead remains operating in a constant current mode so long as ON is active and the thermal shutdown or UVLO have not activated.

Fault Reporting

Upon the detection of an over-current condition, an input UVLO, or an over-temperature condition, the FLAGB signals the fault mode by activating LO. In the event of an over-current condition for the FPF2213 and FPF2214, the FLAGB goes LO at the end of the blanking time while FLAGB goes LO immediately for the FPF2215. If the over-current condition lasts longer than blanking time, FLAGB remains LO through the Auto-Restart Time for the FPF2213 while for the FPF2214, FLAGB is latched LO and ON must be toggled to release it. With the FPF2215, FLAGB is LO during the faults and immediately returns HI at the end of the fault condition. FLAGB is an open-drain MOSFET which requires a pull-up resistor between VIN and FLAGB. During shutdown, the pull-down on FLAGB is disabled to reduce current draw from the supply. A 100K Ω pull up resistor is recommended to be used in the application.

Current Limiting

The current limit ensures that the current through the switch doesn't exceed a maximum value while not limiting at less than a minimum value. The current at which the parts will limit is adjustable through the selection of an external resistor connected to the ISET pin. Information for selecting the resistor is found in the Application Information section of this datasheet. The FPF2213 and FPF2214 have a blanking time of 30ms (nominal) during which the switch will act as a constant current source. At the end of the blanking time, the switch will be turned-off. The FPF2215 has no current limit blanking period so it will remain in a constant current state until the ON pin is deactivated or the thermal shutdown turns-off the switch.

Undervoltage Lockout (UVLO)

The undervoltage lockout turns-off the switch if the input voltage drops below the undervoltage lockout threshold. With the ON pin active the input voltage rising above the undervoltage lockout threshold will cause a controlled turn-on of the switch which limits current over-shoots.

Output Discharge Resistor

The FPF2213/4/5 family contains an 80 Ω on-chip load resistor for quick output discharge when the switch is turned off. This features become more attractive when application requires large output capacitor to be discharge when the switch turns off. However, V_{OUT} pin should not be connected directly to the battery source due to the discharge mechanism of the load switch.

Thermal Shutdown

The thermal shutdown protects the die from internally or externally generated excessive temperatures. During an over-temperature condition the FLAGB is activated and the switch is turned-off. The switch automatically turns-on again if temperature of the die drops below the threshold temperature.

Application Information

Setting Current Limit

The FPF2213, FPF2214, and FPF2215 have adjustable high precision current limit which is set with an external resistor connected between ISET and GND. Please see the layout recommendation section of the application note for the recommended R_{SET} layout. The R_{SET} resistance is selected by using the following equation:

$$I_{LIM(Typ)} (mA) = \frac{7050}{R_{SET} (K\Omega)}$$

For a particular I_{LIM(min)} value, R_{SET} can be calculated from below formula:

$$R_{SET}(K\Omega) = \frac{7050}{I_{LIM(Min)} (mA) + 10 + \frac{750}{I_{LIM(Min)} (mA)}}$$

FPF221X family has 5% precision at higher load current. The I_{LIM(Max)} and tolerance of current limit value can be determined using Figure 21 (I_{LIM} vs R_{SET}) and the following formula:

$$\text{Tolerance (\%)} = 100 * \frac{I_{LIM(Typ)} - I_{LIM(Min)}}{I_{LIM(Typ)}}$$

$$I_{LIM(Max)} = I_{LIM(Typ)} + \frac{I_{LIM(Typ)} * \text{Tolerance (\%)}}{100}$$

The table and figure below can be used to select R_{SET}:

| R _{SET} [kΩ] | Min. Current Limit [mA] | Typ. Current Limit [mA] | Max. Current Limit [mA] | Tol [%] |
|-----------------------|-------------------------|-------------------------|-------------------------|---------|
| 26.8 | 250 | 263 | 276 | 5.0 |
| 28.0 | 238 | 252 | 265 | 5.4 |
| 29.4 | 226 | 240 | 253 | 5.7 |
| 30.0 | 221 | 235 | 249 | 5.8 |
| 32.4 | 204 | 218 | 232 | 6.4 |
| 36.5 | 179 | 193 | 208 | 7.5 |
| 40.2 | 160 | 175 | 190 | 8.5 |
| 48.7 | 129 | 145 | 161 | 11.1 |
| 60.0 | 100 | 118 | 135 | 15.0 |

Table 1: R_{SET} Selection Guide

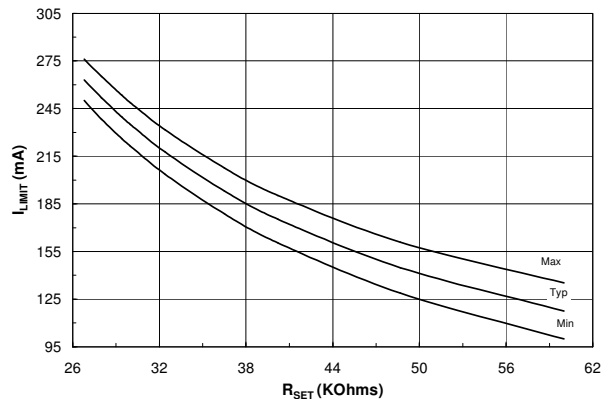

Figure 21. I_{LIM} vs R_{SET}

Input Capacitor

To limit the voltage drop on the input supply caused by transient in-rush currents when the switch is turned on into a discharged load capacitor or a short-circuit, a capacitor is recommended to be placed between V_{IN} and GND. A 1uF ceramic capacitor, C_{IN}, placed close to the pins is usually sufficient. Higher values of C_{IN} can be used to further reduce the voltage drop.

Output Capacitor

A 0.1uF capacitor C_{OUT} should be placed between V_{OUT} and GND. This capacitor will prevent parasitic board inductances from forcing V_{OUT} below GND when the switch turns-off. For the FPF2213 and FPF2214, the total output capacitance needs to be kept below a maximum value, C_{OUT(max)}, to prevent the part from registering an over-current condition and turning-off the switch. The maximum output capacitance can be determined from the following formula:

$$C_{OUT(Max)} = \frac{I_{LIM(Max)} * t_{BLANK(Min)}}{V_{IN}}$$

Power Dissipation

During normal on-state operation, the power dissipated in the device will depend upon the level at which the current limit is set. The maximum allowed setting for the current limit is 250mA and will result in a power dissipation of:

$$P = (I_{LIM})^2 * R_{DS} = (0.25)^2 * 0.275 = 17mW$$

If the part goes into current limit, maximum power dissipation will occur when the output is shorted to ground. For the FPF2213, the power dissipation will be scaled by the Auto-Restart Time, t_{RSTRT}, and the Over Current Blanking Time, t_{BLANK}. Therefore, the maximum power dissipated is:

$$P_{(Max)} = \frac{t_{BLANK}}{t_{BLANK} + t_{RSTRT}} * V_{IN(Max)} * I_{LIM(Max)}$$

$$= \frac{30}{30 + 450} * 5.5 * 0.276 = 94mW$$

Take note that this is below the maximum package power dissipation, and the thermal shutdown feature will act as additional safety to protect the part from damage due to excessive heating. The junction temperature is only able to increase to the thermal shutdown threshold. Once this temperature has been reached, toggling ON will not turn-on the switch until the junction temperature drops. For the FPF2215, a short on the output will cause the part to operate in a constant current state dissipating a worst case power of:

$$P_{(Max)} = V_{IN (MAX)} * I_{LIM (MAX)} = 5.5 * 0.276 = 1.5W$$

This large amount of power will activate the thermal shutdown and the part will cycle in and out of thermal shutdown so long as the ON pin is active and the short is present.

PCB Layout Recommendations

In order to benefit from adjustable, high-precision load switch devices, a high-precision R_{SET} value must be used to set a tight current limit tolerance. Since I_{LIMIT} (current limit value) is determined by the voltage drop across the R_{SET} , a poor PCB layout can introduce parasitic noise on the I_{SET} pin resulting in a minor variation of I_{LIMIT} . To improve the I_{LIMIT} stability, parasitic noise coupling mechanisms from I_{SET} to GND must be minimized. This becomes more critical when I_{LIMIT} is set close to the nominal load current operation where parasitic effects could cause the device to go in and out of current limit and result in an error flag report.

Care must be taken to provide a direct current return path between the R_{SET} ground pad and the device ground pad (pin5). Please see current pad #2 in figure below.

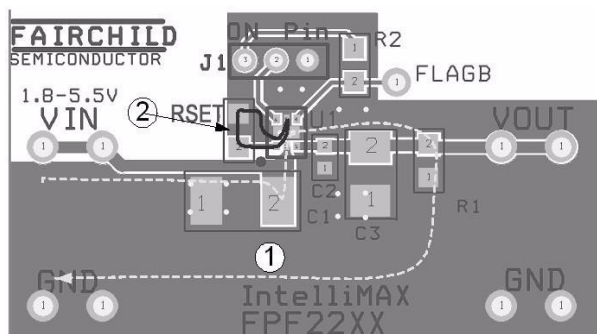

- 1) Power current path
- 2) RSET current path

Figure 22: Eliminate parasitic noise of ISET-GND by providing a separate ground route, unique from the power ground plane

Improving Thermal Performance

An improper layout could result in higher junction temperature and triggering the thermal shutdown protection feature. This concern applies when the switch is set at higher current limit value and an over-current condition occurs. In this case, the power dissipation of the switch, from the formula below, could exceed the maximum absolute power dissipation of 1.2W.

$$PD = (V_{IN} - V_{OUT}) * I_{LIM (MAX)}$$

The following techniques have been identified to improve the thermal performance of this family of devices. These techniques are listed in order of the significance of their impact.

1. Thermal performance of the load switch can be improved by connecting pin7 of the DAP (Die Attach Pad) to the GND plane of the PCB.
2. Embedding two exposed through-hole vias into the DAP (pin7) provides a path for heat to transfer to the back GND plane of the PCB. A drill size of Round, 14 mils (0.35mm) with 1-ounce copper plating is recommended to result in appropriate solder reflow. A smaller size hole prevents the solder from penetrating into the via, resulting in device lift-up. Similarly, a larger via-hole consumes excessive solder, and may result in voiding of the DAP.

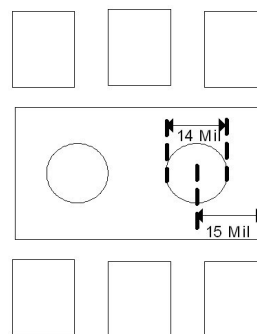

Figure 23: Two through hole open vias embedded in DAP

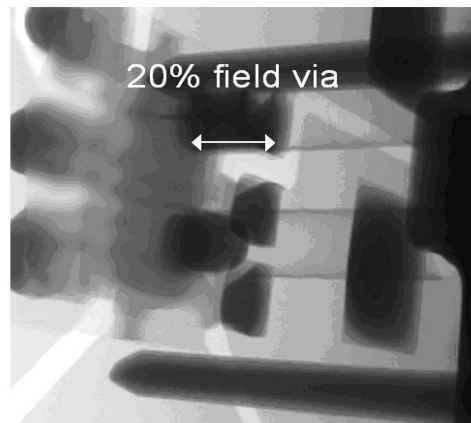

Figure 24: X-Ray result (bottom view with 45° angle)

3. The V_{IN} , V_{OUT} and GND pins will dissipate most of the heat generated during a high load current condition. Using wide traces will help minimize parasitic electrical effects along with minimizing the case to ambient thermal impedance. The layout suggested in Figure 25 provides each pin with adequate copper so that heat may be transferred as efficiently as possible out of the device. The low-power FLAGB and ON pin traces may be laid-out diagonally from the device to maximize the area available to the ground pad. Placing the input and output capacitors as close to the device as possible also contributes to heat dissipation, particularly during high load currents.

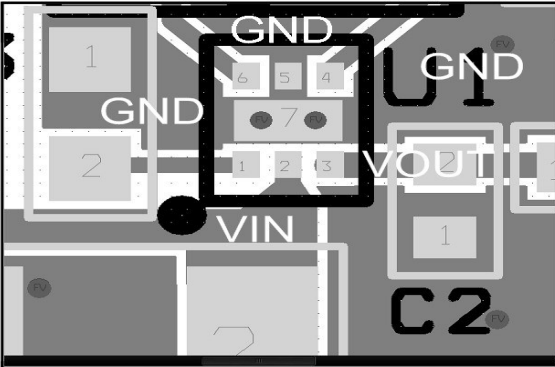

Figure 25: Proper layout of output and ground copper area

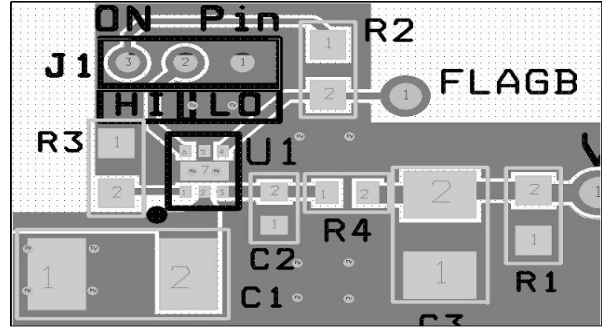

Figure 28: Zoom in to Top layer

FPF22XX Demo Board

FPF22XX Demo board has components and circuitry to demonstrate FPF2213/4/5 load switches functions and features. R4 resistor with 0Ω value is used for measuring the output current. Load current can be scoped by removing the R4 resistor and soldering a current loop to the R4 footprint. Thermal performance of the board is improved using a few techniques recommended in the layout recommendations section of datasheet.

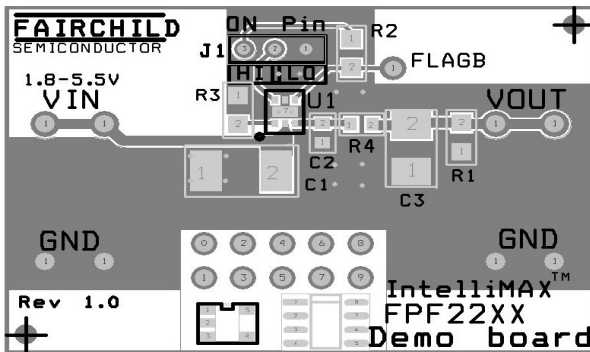

Figure 26: Top, SST, and AST Layers

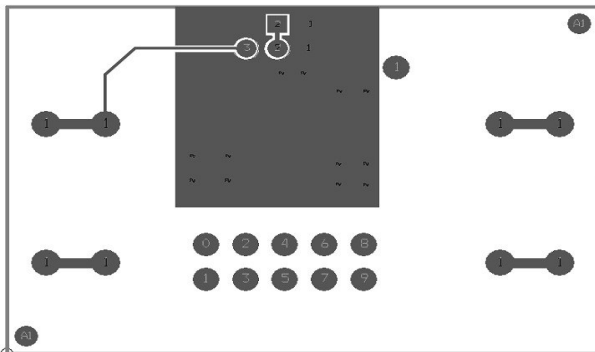
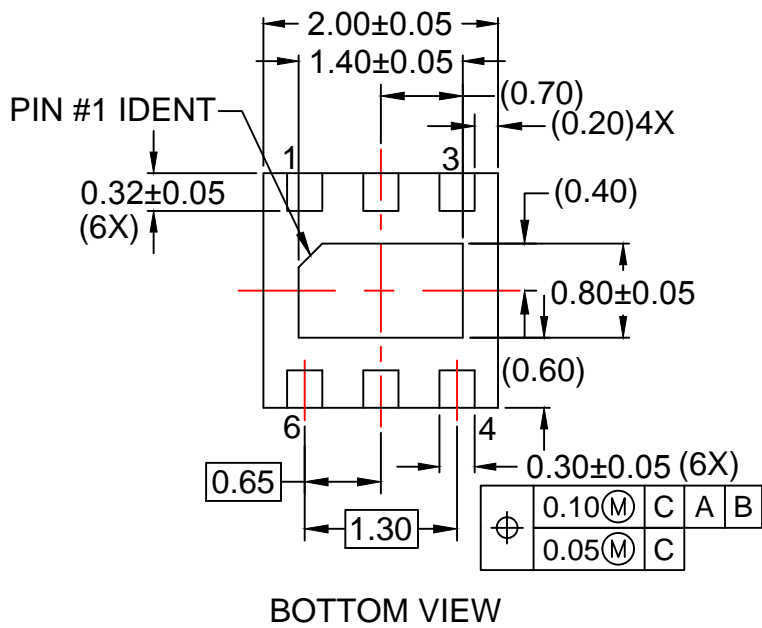
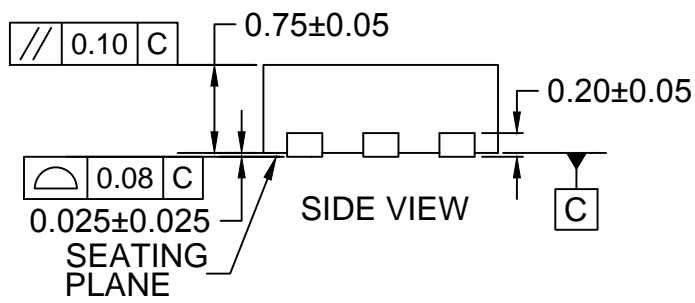
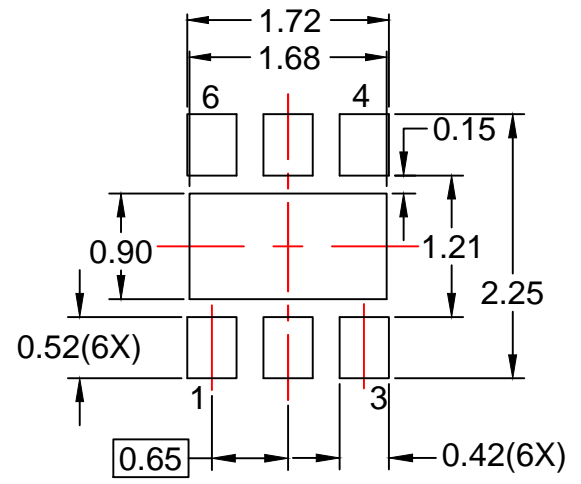
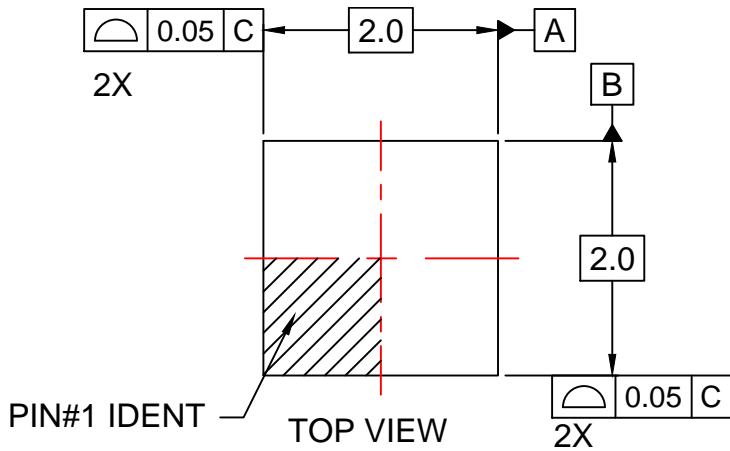

Figure 27: Bottom and ASB Layers



NOTES:

- A. PACKAGE DOES NOT FULLY CONFORM TO JEDEC MO-229 REGISTRATION
- B. DIMENSIONS ARE IN MILLIMETERS.
- C. DIMENSIONS AND TOLERANCES PER ASME Y14.5M, 2009.
- D. LAND PATTERN RECOMMENDATION IS EXISTING INDUSTRY LAND PATTERN.
- E. DRAWING FILENAME: MKT-MLP06Krev5.



ON Semiconductor and  are trademarks of Semiconductor Components Industries, LLC dba ON Semiconductor or its subsidiaries in the United States and/or other countries. ON Semiconductor owns the rights to a number of patents, trademarks, copyrights, trade secrets, and other intellectual property. A listing of ON Semiconductor's product/patent coverage may be accessed at www.onsemi.com/site/pdf/Patent-Marking.pdf. ON Semiconductor reserves the right to make changes without further notice to any products herein. ON Semiconductor makes no warranty, representation or guarantee regarding the suitability of its products for any particular purpose, nor does ON Semiconductor assume any liability arising out of the application or use of any product or circuit, and specifically disclaims any and all liability, including without limitation special, consequential or incidental damages. Buyer is responsible for its products and applications using ON Semiconductor products, including compliance with all laws, regulations and safety requirements or standards, regardless of any support or applications information provided by ON Semiconductor. "Typical" parameters which may be provided in ON Semiconductor data sheets and/or specifications can and do vary in different applications and actual performance may vary over time. All operating parameters, including "Typicals" must be validated for each customer application by customer's technical experts. ON Semiconductor does not convey any license under its patent rights nor the rights of others. ON Semiconductor products are not designed, intended, or authorized for use as a critical component in life support systems or any FDA Class 3 medical devices or medical devices with a same or similar classification in a foreign jurisdiction or any devices intended for implantation in the human body. Should Buyer purchase or use ON Semiconductor products for any such unintended or unauthorized application, Buyer shall indemnify and hold ON Semiconductor and its officers, employees, subsidiaries, affiliates, and distributors harmless against all claims, costs, damages, and expenses, and reasonable attorney fees arising out of, directly or indirectly, any claim of personal injury or death associated with such unintended or unauthorized use, even if such claim alleges that ON Semiconductor was negligent regarding the design or manufacture of the part. ON Semiconductor is an Equal Opportunity/Affirmative Action Employer. This literature is subject to all applicable copyright laws and is not for resale in any manner.

PUBLICATION ORDERING INFORMATION

LITERATURE FULFILLMENT:

Literature Distribution Center for ON Semiconductor
19521 E. 32nd Pkwy, Aurora, Colorado 80011 USA
Phone: 303-675-2175 or 800-344-3860 Toll Free USA/Canada
Fax: 303-675-2176 or 800-344-3867 Toll Free USA/Canada
Email: orderlit@onsemi.com

N. American Technical Support: 800-282-9855 Toll Free
USA/Canada
Europe, Middle East and Africa Technical Support:
Phone: 421 33 790 2910
Japan Customer Focus Center
Phone: 81-3-5817-1050

ON Semiconductor Website: www.onsemi.com
Order Literature: <http://www.onsemi.com/orderlit>
For additional information, please contact your local
Sales Representative

Mouser Electronics

Authorized Distributor

Click to View Pricing, Inventory, Delivery & Lifecycle Information:

[ON Semiconductor:](#)

[FPF2213](#)