

2N3055(NPN), MJ2955(PNP)

Preferred Device

Complementary Silicon Power Transistors

Complementary silicon power transistors are designed for general-purpose switching and amplifier applications.

Features

- DC Current Gain – $h_{FE} = 20-70 @ I_C = 4 \text{ A dc}$
- Collector–Emitter Saturation Voltage –
 $V_{CE(sat)} = 1.1 \text{ Vdc (Max) @ } I_C = 4 \text{ A dc}$
- Excellent Safe Operating Area
- Pb–Free Packages are Available*

MAXIMUM RATINGS

| Rating | Symbol | Value | Unit |
|---|----------------|--------------|--------------------------|
| Collector–Emitter Voltage | V_{CEO} | 60 | Vdc |
| Collector–Emitter Voltage | V_{CER} | 70 | Vdc |
| Collector–Base Voltage | V_{CB} | 100 | Vdc |
| Emitter–Base Voltage | V_{EB} | 7 | Vdc |
| Collector Current – Continuous | I_C | 15 | A dc |
| Base Current | I_B | 7 | A dc |
| Total Power Dissipation @ $T_C = 25^\circ\text{C}$ Derate Above 25°C | P_D | 115 0.657 | W W/ $^\circ\text{C}$ |
| Operating and Storage Junction Temperature Range | T_J, T_{stg} | –65 to +200 | $^\circ\text{C}$ |

Maximum ratings are those values beyond which device damage can occur. Maximum ratings applied to the device are individual stress limit values (not normal operating conditions) and are not valid simultaneously. If these limits are exceeded, device functional operation is not implied, damage may occur and reliability may be affected.

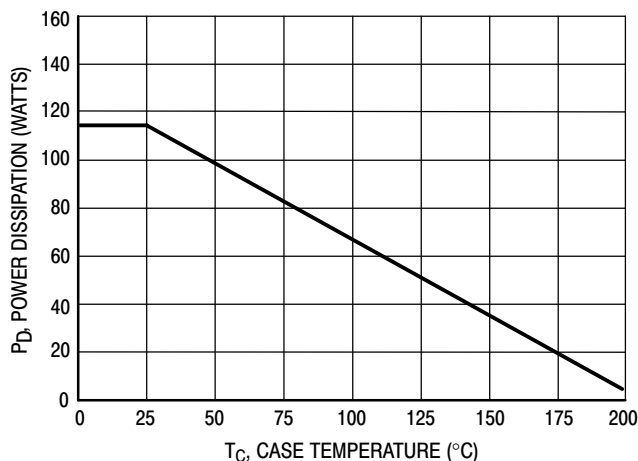

Figure 1. Power Derating

*For additional information on our Pb–Free strategy and soldering details, please download the ON Semiconductor Soldering and Mounting Techniques Reference Manual, SOLDERRM/D.



ON Semiconductor®

<http://onsemi.com>

15 AMPERE POWER TRANSISTORS COMPLEMENTARY SILICON 60 VOLTS, 115 WATTS

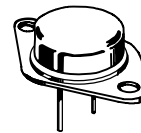

TO-204AA (TO-3)
CASE 1-07
STYLE 1

MARKING DIAGRAM



xxxx55 = Device Code
xxxx = 2N30 or MJ20
G = Pb–Free Package
A = Location Code
YY = Year
WW = Work Week
MEX = Country of Origin

ORDERING INFORMATION

| Device | Package | Shipping |
|---------|-----------------------|------------------|
| 2N3055 | TO–204AA | 100 Units / Tray |
| 2N3055G | TO–204AA (Pb–Free) | 100 Units / Tray |
| MJ2955 | TO–204AA | 100 Units / Tray |
| MJ2955G | TO–204AA (Pb–Free) | 100 Units / Tray |

Preferred devices are recommended choices for future use and best overall value.

2N3055(NPN), MJ2955(PNP)

Thermal Characteristics

| Characteristic | Symbol | Max | Unit |
|--------------------------------------|-----------------|------|----------------------|
| Thermal Resistance, Junction-to-Case | $R_{\theta JC}$ | 1.52 | $^{\circ}\text{C/W}$ |

Electrical Characteristics ($T_C = 25^{\circ}\text{C}$ unless otherwise noted)

| Characteristic | Symbol | Min | Max | Unit |
|----------------|--------|-----|-----|------|
|----------------|--------|-----|-----|------|

OFF CHARACTERISTICS*

| | | | | |
|--|----------------|----|------------|------|
| Collector-Emitter Sustaining Voltage (Note 1) ($I_C = 200\text{ mA dc}$, $I_B = 0$) | $V_{CEO(sus)}$ | 60 | – | Vdc |
| Collector-Emitter Sustaining Voltage (Note 1) ($I_C = 200\text{ mA dc}$, $R_{BE} = 100\ \Omega$) | $V_{CER(sus)}$ | 70 | – | Vdc |
| Collector Cutoff Current ($V_{CE} = 30\text{ Vdc}$, $I_B = 0$) | I_{CEO} | – | 0.7 | mAdc |
| Collector Cutoff Current ($V_{CE} = 100\text{ Vdc}$, $V_{BE(off)} = 1.5\text{ Vdc}$) ($V_{CE} = 100\text{ Vdc}$, $V_{BE(off)} = 1.5\text{ Vdc}$, $T_C = 150^{\circ}\text{C}$) | I_{CEX} | – | 1.0 5.0 | mAdc |
| Emitter Cutoff Current ($V_{BE} = 7.0\text{ Vdc}$, $I_C = 0$) | I_{EBO} | – | 5.0 | mAdc |

ON CHARACTERISTICS* (Note 1)

| | | | | |
|---|---------------|-----------|------------|-----|
| DC Current Gain ($I_C = 4.0\text{ Adc}$, $V_{CE} = 4.0\text{ Vdc}$) ($I_C = 10\text{ Adc}$, $V_{CE} = 4.0\text{ Vdc}$) | h_{FE} | 20 5.0 | 70 – | – |
| Collector-Emitter Saturation Voltage ($I_C = 4.0\text{ Adc}$, $I_B = 400\text{ mA dc}$) ($I_C = 10\text{ Adc}$, $I_B = 3.3\text{ Adc}$) | $V_{CE(sat)}$ | – | 1.1 3.0 | Vdc |
| Base-Emitter On Voltage ($I_C = 4.0\text{ Adc}$, $V_{CE} = 4.0\text{ Vdc}$) | $V_{BE(on)}$ | – | 1.5 | Vdc |

SECOND BREAKDOWN

| | | | | |
|---|-----------|------|---|-----|
| Second Breakdown Collector Current with Base Forward Biased ($V_{CE} = 40\text{ Vdc}$, $t = 1.0\text{ s}$, Nonrepetitive) | $I_{s/b}$ | 2.87 | – | Adc |
|---|-----------|------|---|-----|

DYNAMIC CHARACTERISTICS

| | | | | |
|---|-----------|-----|-----|-----|
| Current Gain – Bandwidth Product ($I_C = 0.5\text{ Adc}$, $V_{CE} = 10\text{ Vdc}$, $f = 1.0\text{ MHz}$) | f_T | 2.5 | – | MHz |
| *Small-Signal Current Gain ($I_C = 1.0\text{ Adc}$, $V_{CE} = 4.0\text{ Vdc}$, $f = 1.0\text{ kHz}$) | h_{fe} | 15 | 120 | – |
| *Small-Signal Current Gain Cutoff Frequency ($V_{CE} = 4.0\text{ Vdc}$, $I_C = 1.0\text{ Adc}$, $f = 1.0\text{ kHz}$) | f_{hfe} | 10 | – | kHz |

*Indicates Within JEDEC Registration. (2N3055)

1. Pulse Test: Pulse Width $\leq 300\ \mu\text{s}$, Duty Cycle $\leq 2.0\%$.

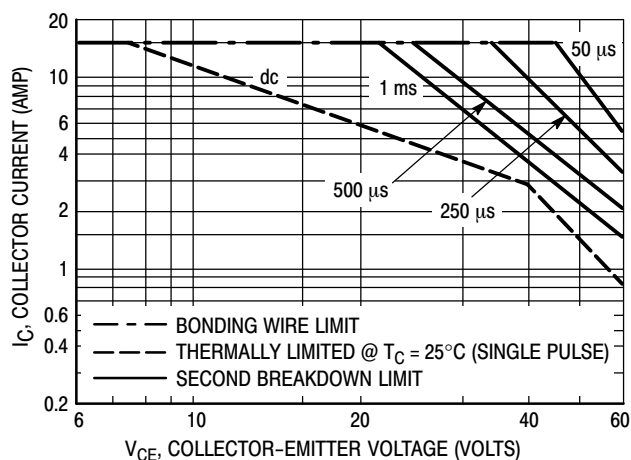

Figure 2. Active Region Safe Operating Area

There are two limitations on the power handling ability of a transistor: average junction temperature and second breakdown. Safe operating area curves indicate $I_C - V_{CE}$ limits of the transistor that must be observed for reliable operation; i.e., the transistor must not be subjected to greater dissipation than the curves indicate.

The data of Figure 2 is based on $T_C = 25^{\circ}\text{C}$; $T_{J(pk)}$ is variable depending on power level. Second breakdown pulse limits are valid for duty cycles to 10% but must be derated for temperature according to Figure 1.

2N3055(NPN), MJ2955(PNP)

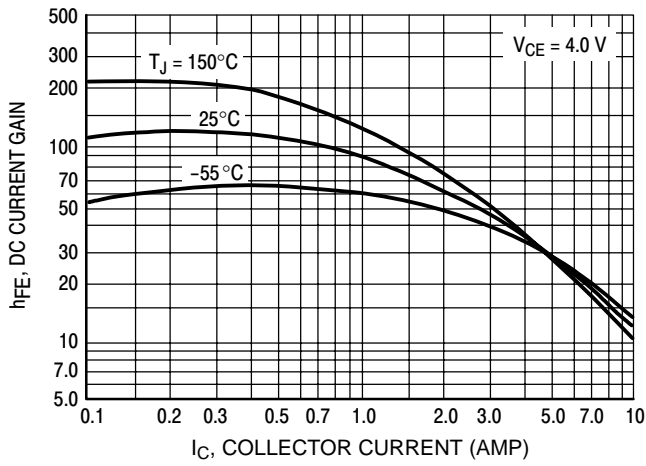

Figure 3. DC Current Gain, 2N3055 (NPN)

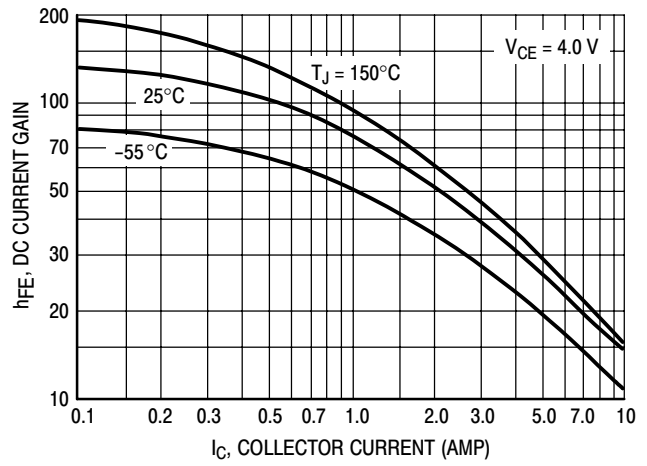

Figure 4. DC Current Gain, MJ2955 (PNP)

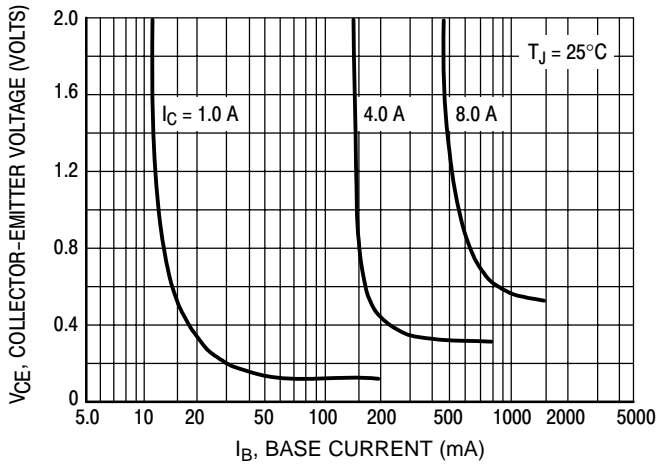

Figure 5. Collector Saturation Region, 2N3055 (NPN)

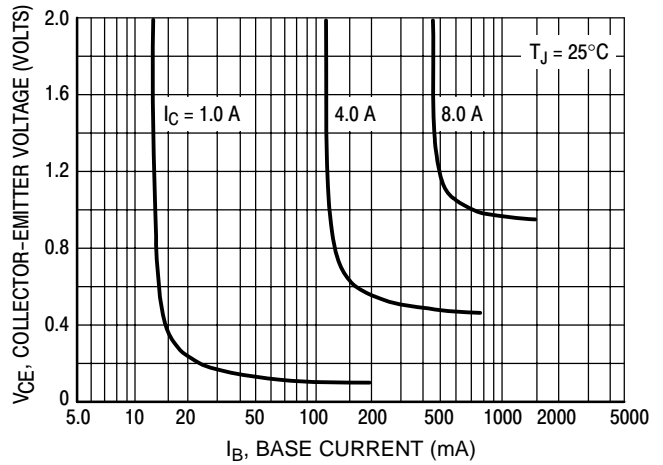

Figure 6. Collector Saturation Region, MJ2955 (PNP)

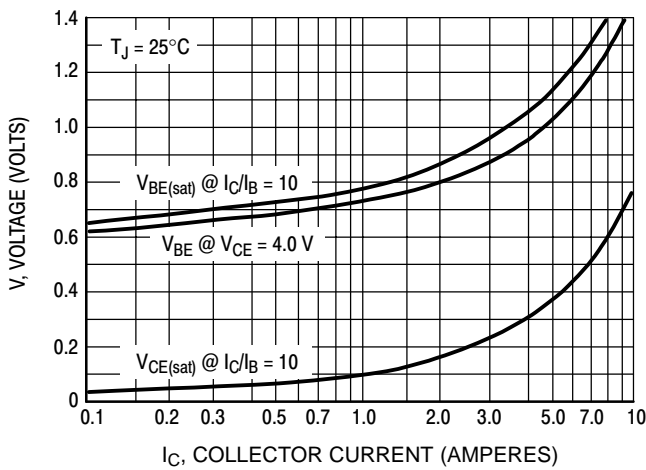

Figure 7. "On" Voltages, 2N3055 (NPN)

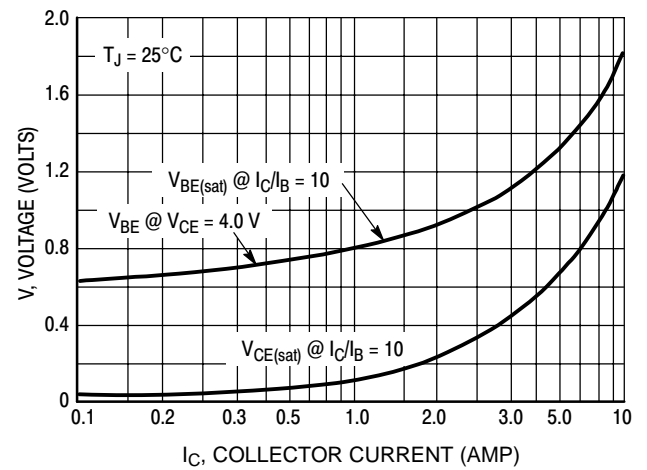
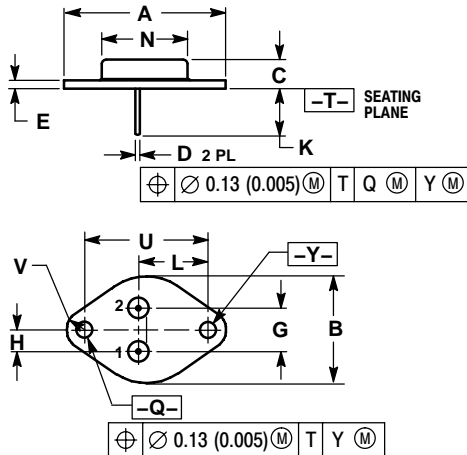

Figure 8. "On" Voltages, MJ2955 (PNP)

2N3055(NPN), MJ2955(PNP)

PACKAGE DIMENSIONS

TO-204 (TO-3)
CASE 1-07
ISSUE Z



NOTES:

- DIMENSIONING AND TOLERANCING PER ANSI Y14.5M, 1982.
- CONTROLLING DIMENSION: INCH.
- ALL RULES AND NOTES ASSOCIATED WITH REFERENCED TO-204AA OUTLINE SHALL APPLY.

| DIM | INCHES | | MILLIMETERS | |
|-----|-----------|-------|-------------|-------|
| | MIN | MAX | MIN | MAX |
| A | 1.550 REF | | 39.37 REF | |
| B | --- | 1.050 | --- | 26.67 |
| C | 0.250 | 0.335 | 6.35 | 8.51 |
| D | 0.038 | 0.043 | 0.97 | 1.09 |
| E | 0.055 | 0.070 | 1.40 | 1.77 |
| G | 0.430 BSC | | 10.92 BSC | |
| H | 0.215 BSC | | 5.46 BSC | |
| K | 0.440 | 0.480 | 11.18 | 12.19 |
| L | 0.665 BSC | | 16.89 BSC | |
| N | --- | 0.830 | --- | 21.08 |
| Q | 0.151 | 0.165 | 3.84 | 4.19 |
| U | 1.187 BSC | | 30.15 BSC | |
| V | 0.131 | 0.188 | 3.33 | 4.77 |

STYLE 1:

- PIN 1. BASE
 - EMITTER
- CASE: COLLECTOR

ON Semiconductor and are registered trademarks of Semiconductor Components Industries, LLC (SCILLC). SCILLC reserves the right to make changes without further notice to any products herein. SCILLC makes no warranty, representation or guarantee regarding the suitability of its products for any particular purpose, nor does SCILLC assume any liability arising out of the application or use of any product or circuit, and specifically disclaims any and all liability, including without limitation special, consequential or incidental damages. "Typical" parameters which may be provided in SCILLC data sheets and/or specifications can and do vary in different applications and actual performance may vary over time. All operating parameters, including "Typicals" must be validated for each customer application by customer's technical experts. SCILLC does not convey any license under its patent rights nor the rights of others. SCILLC products are not designed, intended, or authorized for use as components in systems intended for surgical implant into the body, or other applications intended to support or sustain life, or for any other application in which the failure of the SCILLC product could create a situation where personal injury or death may occur. Should Buyer purchase or use SCILLC products for any such unintended or unauthorized application, Buyer shall indemnify and hold SCILLC and its officers, employees, subsidiaries, affiliates, and distributors harmless against all claims, costs, damages, and expenses, and reasonable attorney fees arising out of, directly or indirectly, any claim of personal injury or death associated with such unintended or unauthorized use, even if such claim alleges that SCILLC was negligent regarding the design or manufacture of the part. SCILLC is an Equal Opportunity/Affirmative Action Employer. This literature is subject to all applicable copyright laws and is not for resale in any manner.

PUBLICATION ORDERING INFORMATION

LITERATURE FULFILLMENT:
Literature Distribution Center for ON Semiconductor
P.O. Box 61312, Phoenix, Arizona 85082-1312 USA
Phone: 480-829-7710 or 800-344-3860 Toll Free USA/Canada
Fax: 480-829-7709 or 800-344-3867 Toll Free USA/Canada
Email: orderlit@onsemi.com

N. American Technical Support: 800-282-9855 Toll Free
USA/Canada

Japan: ON Semiconductor, Japan Customer Focus Center
2-9-1 Kamimeguro, Meguro-ku, Tokyo, Japan 153-0051
Phone: 81-3-5773-3850

ON Semiconductor Website: <http://onsemi.com>

Order Literature: <http://www.onsemi.com/litorder>

For additional information, please contact your local Sales Representative.

Mouser Electronics

Authorized Distributor

Click to View Pricing, Inventory, Delivery & Lifecycle Information:

[ON Semiconductor:](#)

[MJ2955](#)