

2N7000G

Small Signal MOSFET 200 mAmps, 60 Volts N-Channel TO-92

Features

- AEC Qualified
- PPAP Capable
- This is a Pb-Free Device*

MAXIMUM RATINGS

Rating	Symbol	Value	Unit
Drain Source Voltage	V_{DSS}	60	Vdc
Drain-Gate Voltage ($R_{GS} = 1.0 \text{ M}\Omega$)	V_{DGR}	60	Vdc
Gate-Source Voltage	V_{GS}	± 20	Vdc
- Continuous	V_{GSM}	± 40	Vpk
- Non-repetitive ($t_p \leq 50 \mu\text{s}$)			
Drain Current	I_D	200	mAdc
- Continuous	I_{DM}	500	
- Pulsed			
Total Power Dissipation @ $T_C = 25^\circ\text{C}$ Derate above 25°C	P_D	350 2.8	mW mW/ $^\circ\text{C}$
Operating and Storage Temperature Range	T_J, T_{stg}	-55 to +150	$^\circ\text{C}$

THERMAL CHARACTERISTICS

Characteristic	Symbol	Max	Unit
Thermal Resistance, Junction-to-Ambient	$R_{\theta JA}$	357	$^\circ\text{C}/\text{W}$
Maximum Lead Temperature for Soldering Purposes, 1/16" from case for 10 seconds	T_L	300	$^\circ\text{C}$

Stresses exceeding Maximum Ratings may damage the device. Maximum Ratings are stress ratings only. Functional operation above the Recommended Operating Conditions is not implied. Extended exposure to stresses above the Recommended Operating Conditions may affect device reliability.

*For additional information on our Pb-Free strategy and soldering details, please download the ON Semiconductor Soldering and Mounting Techniques Reference Manual, SOLDERRM/D.



ON Semiconductor®

<http://onsemi.com>

**200 mAmps
60 Volts**

$R_{DS(on)} = 5 \Omega$

N-Channel

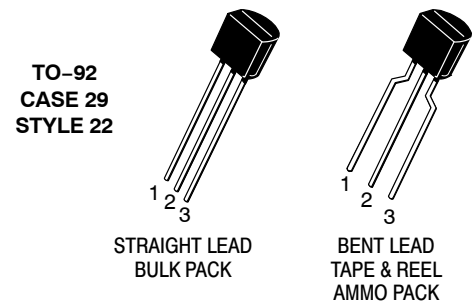
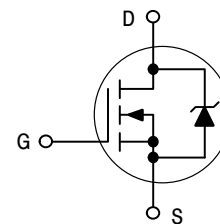

MARKING DIAGRAM AND PIN ASSIGNMENT

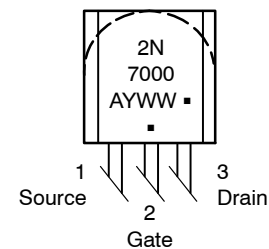

- A = Assembly Location
- Y = Year
- WW = Work Week
- = Pb-Free Package

(Note: Microdot may be in either location)

ORDERING INFORMATION

See detailed ordering and shipping information in the package dimensions section on page 2 of this data sheet.

2N7000G

ELECTRICAL CHARACTERISTICS ($T_C = 25^\circ\text{C}$ unless otherwise noted)

Characteristic	Symbol	Min	Max	Unit
----------------	--------	-----	-----	------

OFF CHARACTERISTICS

Drain–Source Breakdown Voltage ($V_{GS} = 0, I_D = 10 \mu\text{Adc}$)	$V_{(BR)DSS}$	60	–	Vdc
Zero Gate Voltage Drain Current ($V_{DS} = 48 \text{ Vdc}, V_{GS} = 0$) ($V_{DS} = 48 \text{ Vdc}, V_{GS} = 0, T_J = 125^\circ\text{C}$)	I_{DSS}	–	1.0	μAdc mAdc
Gate–Body Leakage Current, Forward ($V_{GSF} = 15 \text{ Vdc}, V_{DS} = 0$)	I_{GSSF}	–	–10	nAdc

ON CHARACTERISTICS (Note 1)

Gate Threshold Voltage ($V_{DS} = V_{GS}, I_D = 1.0 \text{ mAdc}$)	$V_{GS(th)}$	0.8	3.0	Vdc
Static Drain–Source On–Resistance ($V_{GS} = 10 \text{ Vdc}, I_D = 0.5 \text{ Adc}$) ($V_{GS} = 4.5 \text{ Vdc}, I_D = 75 \text{ mAdc}$)	$r_{DS(on)}$	–	5.0 6.0	Ω
Drain–Source On–Voltage ($V_{GS} = 10 \text{ Vdc}, I_D = 0.5 \text{ Adc}$) ($V_{GS} = 4.5 \text{ Vdc}, I_D = 75 \text{ mAdc}$)	$V_{DS(on)}$	–	2.5 0.45	Vdc
On–State Drain Current ($V_{GS} = 4.5 \text{ Vdc}, V_{DS} = 10 \text{ Vdc}$)	$I_{d(on)}$	75	–	mAdc
Forward Transconductance ($V_{DS} = 10 \text{ Vdc}, I_D = 200 \text{ mAdc}$)	g_{fs}	100	–	μmhos

DYNAMIC CHARACTERISTICS

Input Capacitance	$(V_{DS} = 25 \text{ V}, V_{GS} = 0,$ $f = 1.0 \text{ MHz})$	C_{iss}	–	60	pF
Output Capacitance		C_{oss}	–	25	
Reverse Transfer Capacitance		C_{rss}	–	5.0	

SWITCHING CHARACTERISTICS (Note 1)

Turn–On Delay Time	$(V_{DD} = 15 \text{ V}, I_D = 500 \text{ mA},$ $R_G = 25 \Omega, R_L = 30 \Omega, V_{gen} = 10 \text{ V})$	t_{on}	–	10	ns
Turn–Off Delay Time		t_{off}	–	10	

1. Pulse Test: Pulse Width $\leq 300 \mu\text{s}$, Duty Cycle $\leq 2.0\%$.

ORDERING INFORMATION

Device	Package	Shipping†
2N7000G	TO–92 (Pb–Free)	1000 Units / Bulk
2N7000RLRAG	TO–92 (Pb–Free)	2000 Tape & Reel

†For information on tape and reel specifications, including part orientation and tape sizes, please refer to our Tape and Reel Packaging Specifications Brochure, BRD8011/D.

2N7000G

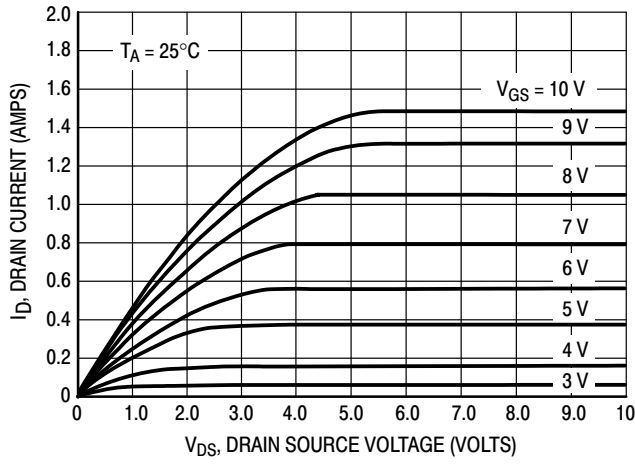

Figure 1. Ohmic Region

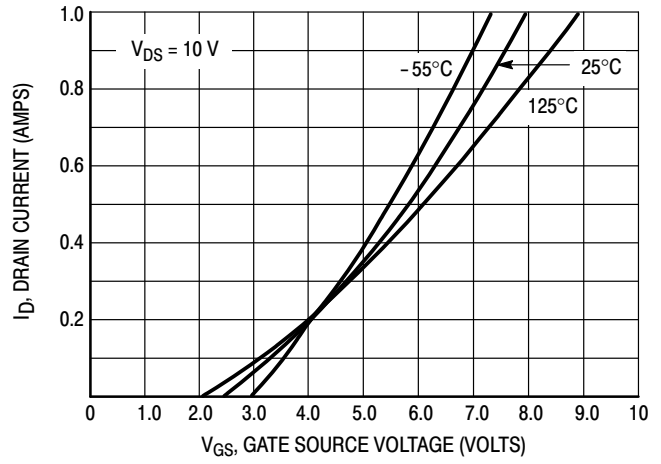

Figure 2. Transfer Characteristics

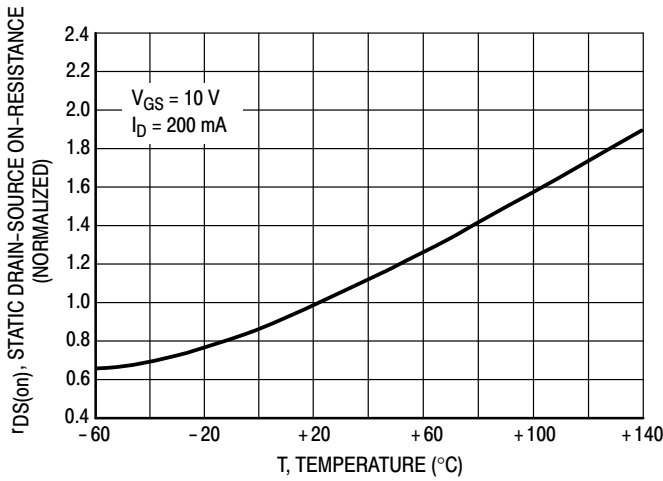

Figure 3. Temperature versus Static Drain-Source On-Resistance

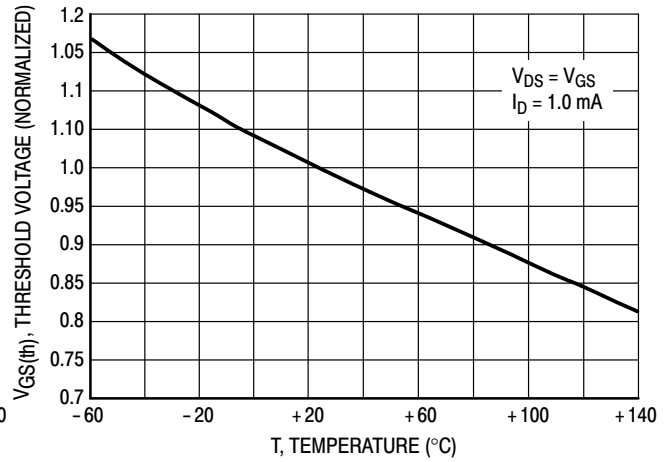
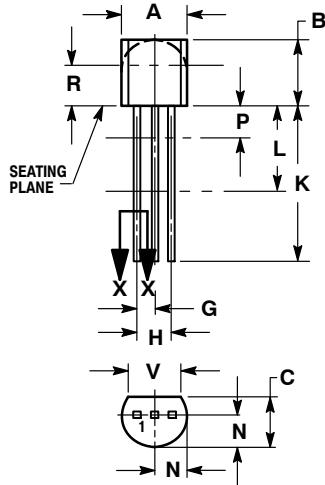

Figure 4. Temperature versus Gate Threshold Voltage

2N700G

PACKAGE DIMENSIONS

TO-92 (TO-226)
CASE 29-11
ISSUE AM



STRAIGHT LEAD
BULK PACK

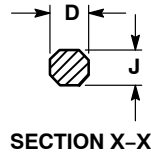

NOTES:

1. DIMENSIONING AND TOLERANCING PER ANSI Y14.5M, 1982.
2. CONTROLLING DIMENSION: INCH.
3. CONTOUR OF PACKAGE BEYOND DIMENSION R IS UNCONTROLLED.
4. LEAD DIMENSION IS UNCONTROLLED IN P AND BEYOND DIMENSION K MINIMUM.

DIM	INCHES		MILLIMETERS	
	MIN	MAX	MIN	MAX
A	0.175	0.205	4.45	5.20
B	0.170	0.210	4.32	5.33
C	0.125	0.165	3.18	4.19
D	0.016	0.021	0.407	0.533
G	0.045	0.055	1.15	1.39
H	0.095	0.105	2.42	2.66
J	0.015	0.020	0.39	0.50
K	0.500	---	12.70	---
L	0.250	---	6.35	---
N	0.080	0.105	2.04	2.66
P	---	0.100	---	2.54
R	0.115	---	2.93	---
V	0.135	---	3.43	---

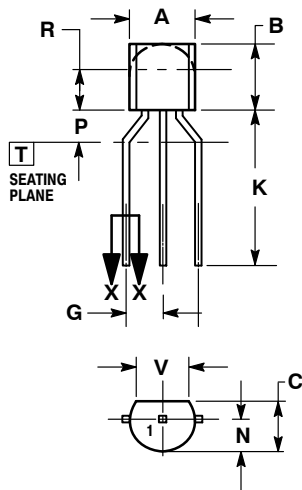

BENT LEAD
TAPE & REEL
AMMO PACK

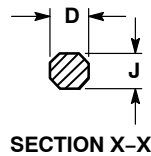

NOTES:

1. DIMENSIONING AND TOLERANCING PER ASME Y14.5M, 1994.
2. CONTROLLING DIMENSION: MILLIMETERS.
3. CONTOUR OF PACKAGE BEYOND DIMENSION R IS UNCONTROLLED.
4. LEAD DIMENSION IS UNCONTROLLED IN P AND BEYOND DIMENSION K MINIMUM.

DIM	MILLIMETERS	
	MIN	MAX
A	4.45	5.20
B	4.32	5.33
C	3.18	4.19
D	0.40	0.54
G	2.40	2.80
J	0.39	0.50
K	12.70	---
N	2.04	2.66
P	1.50	4.00
R	2.93	---
V	3.43	---

STYLE 22:

1. SOURCE
2. GATE
3. DRAIN

ON Semiconductor and are registered trademarks of Semiconductor Components Industries, LLC (SCILLC). SCILLC reserves the right to make changes without further notice to any products herein. SCILLC makes no warranty, representation or guarantee regarding the suitability of its products for any particular purpose, nor does SCILLC assume any liability arising out of the application or use of any product or circuit, and specifically disclaims any and all liability, including without limitation special, consequential or incidental damages. "Typical" parameters which may be provided in SCILLC data sheets and/or specifications can and do vary in different applications and actual performance may vary over time. All operating parameters, including "Typicals" must be validated for each customer application by customer's technical experts. SCILLC does not convey any license under its patent rights nor the rights of others. SCILLC products are not designed, intended, or authorized for use as components in systems intended for surgical implant into the body, or other applications intended to support or sustain life, or for any other application in which the failure of the SCILLC product could create a situation where personal injury or death may occur. Should Buyer purchase or use SCILLC products for any such unintended or unauthorized application, Buyer shall indemnify and hold SCILLC and its officers, employees, subsidiaries, affiliates, and distributors harmless against all claims, costs, damages, and expenses, and reasonable attorney fees arising out of, directly or indirectly, any claim of personal injury or death associated with such unintended or unauthorized use, even if such claim alleges that SCILLC was negligent regarding the design or manufacture of the part. SCILLC is an Equal Opportunity/Affirmative Action Employer. This literature is subject to all applicable copyright laws and is not for resale in any manner.

PUBLICATION ORDERING INFORMATION

LITERATURE FULFILLMENT:
Literature Distribution Center for ON Semiconductor
P.O. Box 5163, Denver, Colorado 80217 USA
Phone: 303-675-2175 or 800-344-3860 Toll Free USA/Canada
Fax: 303-675-2176 or 800-344-3867 Toll Free USA/Canada
Email: orderlit@onsemi.com

N. American Technical Support: 800-282-9855 Toll Free
USA/Canada
Europe, Middle East and Africa Technical Support:
Phone: 421 33 790 2910
Japan Customer Focus Center
Phone: 81-3-5773-3850

ON Semiconductor Website: www.onsemi.com
Order Literature: <http://www.onsemi.com/orderlit>
For additional information, please contact your local Sales Representative

Mouser Electronics

Authorized Distributor

Click to View Pricing, Inventory, Delivery & Lifecycle Information:

ON Semiconductor:

[2N7000](#) [2N7000G](#) [2N7000RLRA](#) [2N7000RLRAG](#) [2N7000RLRM](#) [2N7000RLRMG](#) [2N7000RLRP](#) [2N7000RLRPG](#)
[2N7000BU](#) [2N7000TA](#) [2N7000_D75Z](#) [2N7000](#) [2N7000_D74Z](#) [2N7000_D26Z](#) [2N7000_Q](#) [2N7000_D26Z_Q](#)
[2N7000-D74Z](#) [2N7000-D26Z](#) [2N7000-D75Z](#)