

Silicon Carbide (SiC) Module – EliteSiC, 10 mohm SiC M2 MOSFET, 900 V, 2-PACK Half Bridge Topology, F1 Package

NXH010P90MNF1PTG, NXH010P90MNF1PG

The NXH010P120MNF1 is a power module containing an 10 mΩ/900 V SiC MOSFET half bridge and a thermistor in an F1 package.

Features

- 10 mΩ/900 V SiC MOSFET Half Bridge
- Thermistor
- Options with Pre-applied Thermal Interface Material (TIM) and without Pre-applied TIM
- Press-fit Pins

Typical Applications

- Solar Inverter
- Uninterruptible Power Supplies
- Electric Vehicle Charging Stations
- Industrial Power

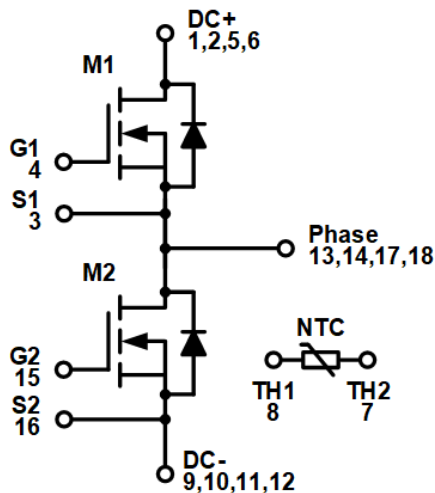
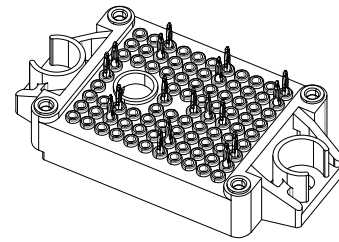
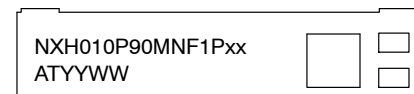

Figure 1. NXH010P90MNF1 Schematic Diagram



PIM18 33.8x42.5 (PRESS FIT)
CASE 180BW

MARKING DIAGRAM



NXH010P90MNF1PTG = Specific Device Code
 NXH010P90MNF1PG = Specific Device Code
 AT = Assembly & Test Site Code
 YYWW = Year and Work Week Code

PIN CONNECTIONS

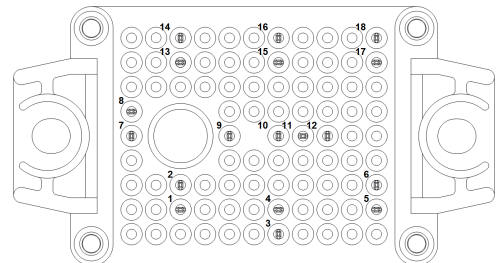

See Pin Function Description for pin names

ORDERING INFORMATION

See detailed ordering and shipping information on page 4 of this data sheet.

NXH010P90MNF1PTG, NXH010P90MNF1PG

PIN FUNCTION DESCRIPTION

| Pin | Name | Description |
|-----|-------|--------------------------------------|
| 1 | DC+ | DC Positive Bus connection |
| 2 | DC+ | DC Positive Bus connection |
| 3 | S1 | Q1 Kelvin Emitter (High side switch) |
| 4 | G1 | Q1 Gate (High side switch) |
| 5 | DC+ | DC Positive Bus connection |
| 6 | DC+ | DC Positive Bus connection |
| 7 | TH2 | Thermistor Connection 2 |
| 8 | TH1 | Thermistor Connection 1 |
| 9 | DC- | DC Negative Bus connection |
| 10 | DC- | DC Negative Bus connection |
| 11 | DC- | DC Negative Bus connection |
| 12 | DC- | DC Negative Bus connection |
| 13 | PHASE | Center point of half bridge |
| 14 | PHASE | Center point of half bridge |
| 15 | G2 | Q2 Gate (Low side switch) |
| 16 | S2 | Q2 Kelvin Emitter (High side switch) |
| 17 | PHASE | Center point of half bridge |
| 18 | PHASE | Center point of half bridge |

MAXIMUM RATINGS

| Rating | Symbol | Value | Unit |
|------------------------------------------------------------------------------------|--------------|--------|------------------|
| SiC MOSFET | | | |
| Drain-Source Voltage | V_{DSS} | 900 | V |
| Gate-Source Voltage | V_{GS} | +18/-8 | V |
| Continuous Drain Current @ $T_C = 80^\circ\text{C}$ ($T_J = 175^\circ\text{C}$) | I_D | 154 | A |
| Pulsed Drain Current ($T_J = 175^\circ\text{C}$) | I_{Dpulse} | 308 | A |
| Maximum Power Dissipation @ $T_C = 80^\circ\text{C}$ ($T_J = 175^\circ\text{C}$) | P_{tot} | 328 | W |
| Minimum Operating Junction Temperature | T_{JMIN} | -40 | $^\circ\text{C}$ |
| Maximum Operating Junction Temperature | T_{JMAX} | 175 | $^\circ\text{C}$ |

THERMAL PROPERTIES

| | | | |
|---------------------------|-----------|------------|------------------|
| Storage Temperature range | T_{stg} | -40 to 150 | $^\circ\text{C}$ |
|---------------------------|-----------|------------|------------------|

INSULATION PROPERTIES

| | | | |
|------------------------------------------|----------|------|-----------|
| Isolation test voltage, $t = 1$ s, 60 Hz | V_{is} | 4800 | V_{RMS} |
| Creepage distance | | 12.7 | mm |

Stresses exceeding those listed in the Maximum Ratings table may damage the device. If any of these limits are exceeded, device functionality should not be assumed, damage may occur and reliability may be affected.

1. Refer to ELECTRICAL CHARACTERISTICS, RECOMMENDED OPERATING RANGES and/or APPLICATION INFORMATION for Safe Operating parameters.

RECOMMENDED OPERATING RANGES

| Rating | Symbol | Min | Max | Unit |
|---------------------------------------|--------|-----|-----|------------------|
| Module Operating Junction Temperature | T_J | -40 | 150 | $^\circ\text{C}$ |

Functional operation above the stresses listed in the Recommended Operating Ranges is not implied. Extended exposure to stresses beyond the Recommended Operating Ranges limits may affect device reliability.

NXH010P90MNF1PTG, NXH010P90MNF1PG

ELECTRICAL CHARACTERISTICS (T_J = 25°C unless otherwise noted)

| Parameter | Test Conditions | Symbol | Min | Typ | Max | Unit | |
|---------------------------------------|----------------------------------------------------------------------------------------------------------------------------------|-----------------------|------|--------|-----|------|----|
| SIC MOSFET CHARACTERISTICS | | | | | | | |
| Drain-Source Breakdown Voltage | V _{GS} = 0 V, I _D = 400 μA | V _{(BR)DSS} | 900 | - | - | V | |
| Zero Gate Voltage Drain Current | V _{GS} = 0 V, V _{DS} = 900 V | I _{DSS} | - | - | 200 | μA | |
| Drain-Source On Resistance | V _{GS} = 15 V, I _D = 100 A, T _J = 25°C | R _{DS(ON)} | - | 10.03 | 14 | mΩ | |
| | V _{GS} = 15 V, I _D = 100 A, T _J = 125°C | | - | 10.08 | - | | |
| | V _{GS} = 15 V, I _D = 100 A, T _J = 150°C | | - | 11.61 | - | | |
| Gate-Source Threshold Voltage | V _{GS} = V _{DS} , I _D = 40 mA | V _{GS(TH)} | 1.8 | 2.74 | 4.3 | V | |
| Gate Leakage Current | V _{GS} = -5/15 V, V _{DS} = 0 V | I _{GSS} | -500 | - | 500 | nA | |
| Internal Gate Resistance | | R _G | | 0.8 | | Ω | |
| Input Capacitance | V _{DS} = 450 V, V _{GS} = 0 V, f = 1 MHz | C _{ISS} | - | 7007 | - | pF | |
| Reverse Transfer Capacitance | | C _{RSS} | - | 44 | - | | |
| Output Capacitance | | C _{OSS} | - | 665 | - | | |
| C _{OSS} Stored Energy | V _{DS} = 0 V to 800 V, V _{GS} = 0 V | E _{OSS} | - | 251 | - | μJ | |
| Total Gate Charge | V _{DS} = 720 V, V _{GS} = -15/15 V, I _D = 100 A | Q _{G(TOTAL)} | - | 546.4 | - | nC | |
| Gate-Source Charge | | Q _{GS} | - | 105.45 | - | nC | |
| Gate-Drain Charge | | Q _{GD} | - | 122.7 | - | nC | |
| Turn-on Delay Time | T _J = 25°C V _{DS} = 600 V, I _D = 100 A V _{GS} = -5 V/18 V, R _G = 1.5 Ω | t _{d(on)} | - | 53 | - | ns | |
| Rise Time | | t _r | - | 16 | - | | |
| Turn-off Delay Time | | t _{d(off)} | - | 150 | - | | |
| Fall Time | | t _f | - | 12 | - | | |
| Turn-on Switching Loss per Pulse | | E _{ON} | - | 1.13 | - | | mJ |
| Turn off Switching Loss per Pulse | | E _{OFF} | - | 0.65 | - | | |
| Turn-on Delay Time | T _J = 150°C V _{DS} = 600 V, I _D = 100 A V _{GS} = -5 V/18 V, R _G = 1.5 Ω | t _{d(on)} | - | 50.4 | - | ns | |
| Rise Time | | t _r | - | 15.5 | - | | |
| Turn-off Delay Time | | t _{d(off)} | - | 165 | - | | |
| Fall Time | | t _f | - | 13 | - | | |
| Turn-on Switching Loss per Pulse | | E _{ON} | - | 1.24 | - | | mJ |
| Turn off Switching Loss per Pulse | | E _{OFF} | - | 0.67 | - | | |
| Diode Forward Voltage | I _D = 100 A, T _J = 25°C | V _{SD} | - | 4.47 | 6 | V | |
| | I _D = 100 A, T _J = 150°C | | - | 3.92 | - | | |
| Thermal Resistance - Chip-to-Case | M1, M2 | R _{thJC} | - | 0.29 | - | °C/W | |
| Thermal Resistance - Chip-to-Heatsink | Thermal grease, Thickness = 2 Mil _2%, A = 2.8 W/mK | R _{thJH} | - | 0.46 | - | °C/W | |

THERMISTOR CHARACTERISTICS

| | | | | | | |
|---------------------------------------|----------------------------------|------------------|----|-------|---|------|
| Nominal Resistance | T _{NTC} = 25°C | R ₂₅ | - | 5 | - | kΩ |
| Nominal Resistance | T _{NTC} = 100°C | R ₁₀₀ | - | 493 | - | Ω |
| Nominal Resistance | T _{NTC} = 150°C | R ₁₅₀ | - | 159.5 | - | Ω |
| Deviation of R ₁₀₀ | T _{NTC} = 100°C | ΔR/R | -5 | - | 5 | % |
| Power Dissipation - Recommended Limit | 0.15 mA, non-self-heating effect | P _D | - | 0.1 | - | mW |
| Power Dissipation - Absolute Maximum | 5 mA | P _D | - | 34.2 | - | mW |
| Power Dissipation Constant | | | - | 1.4 | - | mW/K |
| B-value | B(25/50), tolerance ±2% | | - | 3375 | - | K |
| B-value | B(25/100), tolerance ±2% | | - | 3436 | - | K |

Product parametric performance is indicated in the Electrical Characteristics for the listed test conditions, unless otherwise noted. Product performance may not be indicated by the Electrical Characteristics if operated under different conditions.

NXH010P90MNF1PTG, NXH010P90MNF1PG

ORDERING INFORMATION

| Orderable Part Number | Marking | Package | Shipping |
|-----------------------|------------------|--------------------------------------------------------------------------------------------------------------------------|-------------------------|
| NXH010P90MNF1PG | NXH010P90MNF1PG | F1-2PACK: Case 180BW Press-fit Pins (Pb-Free and Halide-Free) | 28 Units / Blister Tray |
| NXH010P90MNF1PTG | NXH010P90MNF1PTG | F1-2PACK: Case 180BW Press-fit Pins with pre-applied thermal interface material (TIM) (Pb-Free and Halide-Free) | 28 Units / Blister Tray |

NXH010P90MNF1PTG, NXH010P90MNF1PG

TYPICAL CHARACTERISTICS SIC MOSFET (M1/M2)

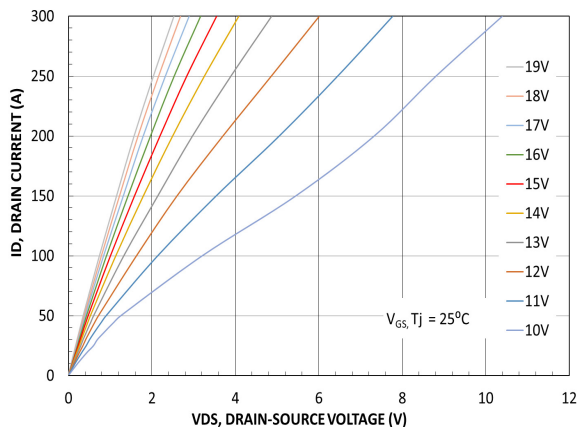

Figure 2. MOSFET Typical Output Characteristics

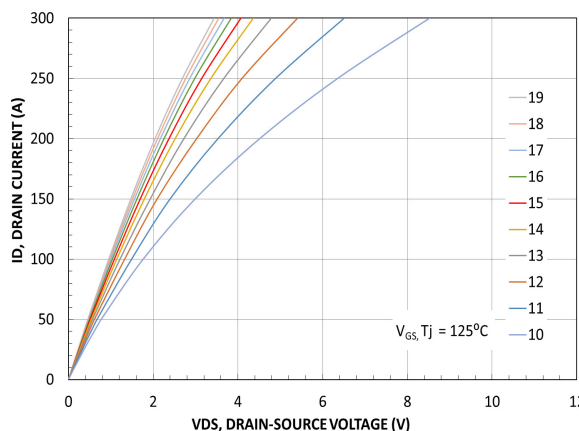

Figure 3. MOSFET Typical Output Characteristics

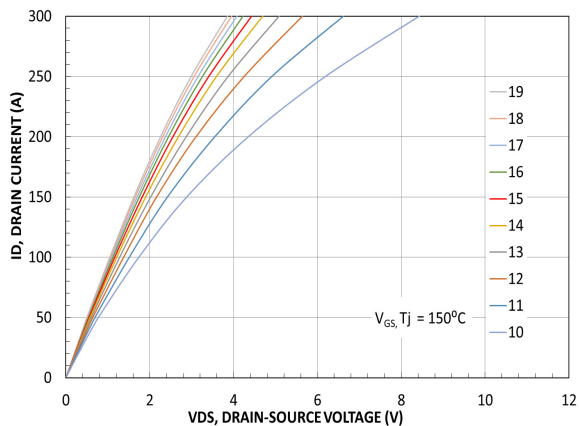

Figure 4. MOSFET Typical Output Characteristics

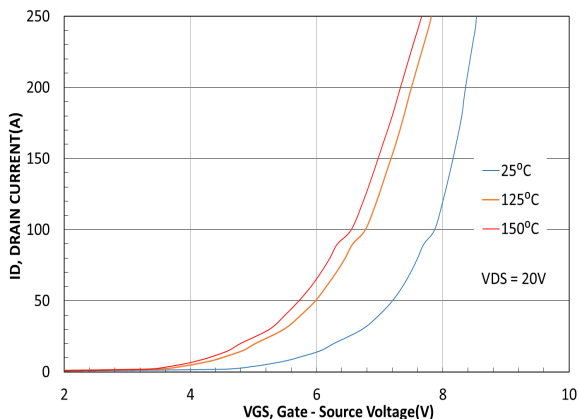

Figure 5. MOSFET Typical Transfer Characteristics

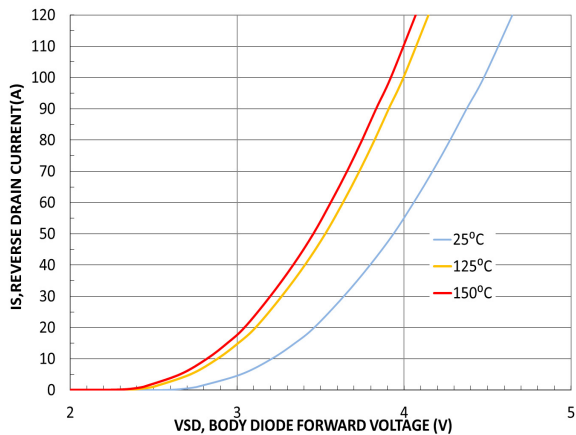

Figure 6. Body Diode Forward Characteristics

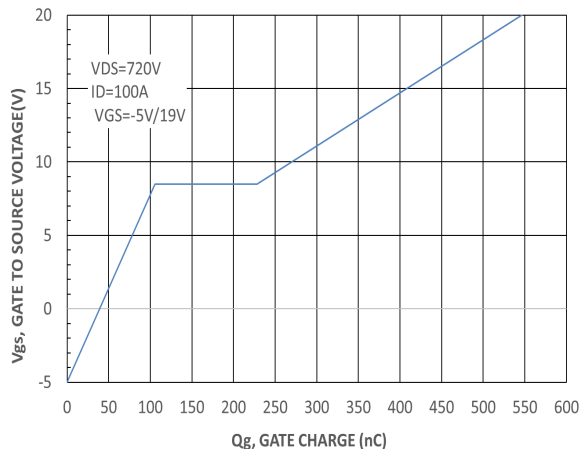

Figure 7. Gate-to-Source Voltage vs. Total Charge

TYPICAL CHARACTERISTICS

SIC MOSFET (M1/M2)

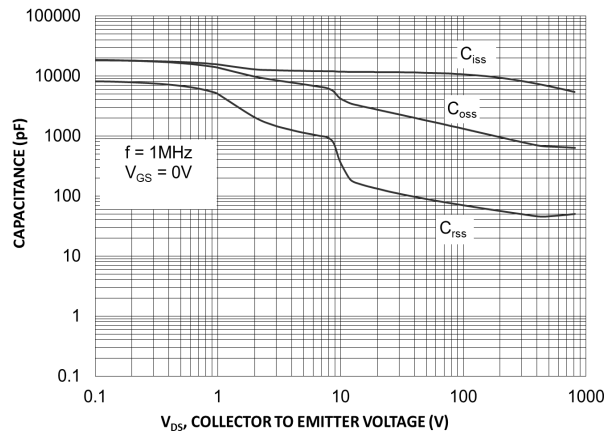

Figure 8. Capacitance vs. Drain-to-Source Voltage

NXH010P90MNF1PTG, NXH010P90MNF1PG

TYPICAL CHARACTERISTICS

M1/M2 MOSFET SWITCHING CHARACTERISTICS

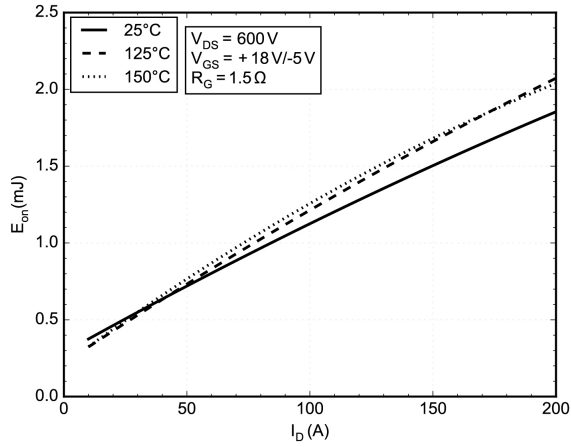

Figure 9. Typical Switching Loss E_{on} vs. I_D

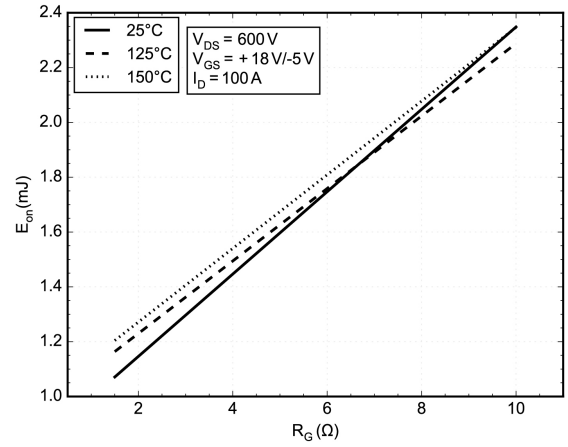

Figure 10. Typical Switching Loss E_{on} vs. R_G

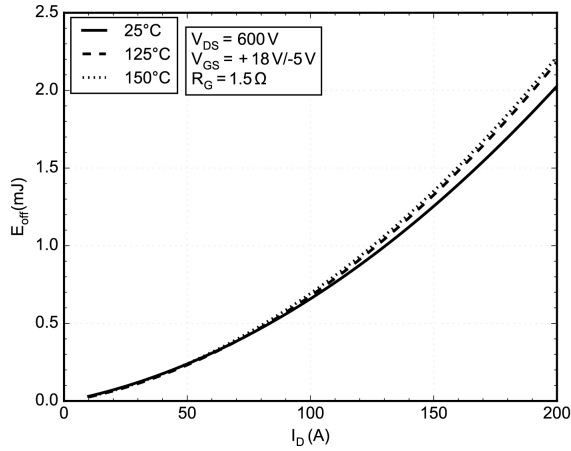

Figure 11. Typical Switching Loss E_{off} vs. I_D

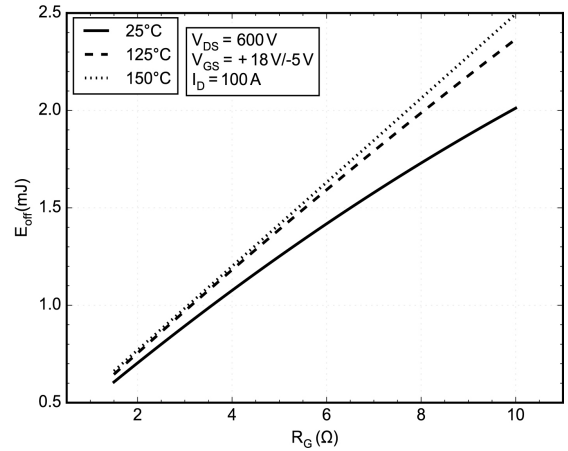

Figure 12. Typical Switching Loss E_{off} vs. R_G

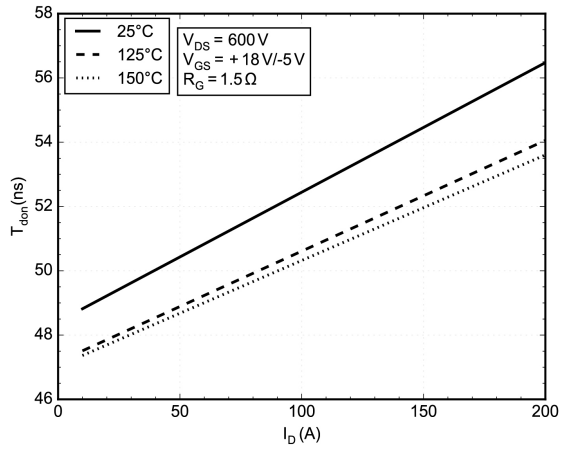

Figure 13. Typical Turn-On Switching $T_{d(on)}$ vs. I_D

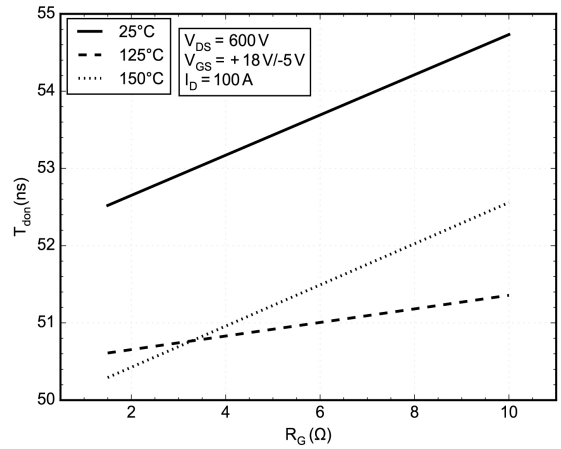

Figure 14. Typical Turn-On Switching $T_{d(on)}$ vs. R_G

NXH010P90MNF1PTG, NXH010P90MNF1PG

TYPICAL CHARACTERISTICS

M1/M2 MOSFET SWITCHING CHARACTERISTICS

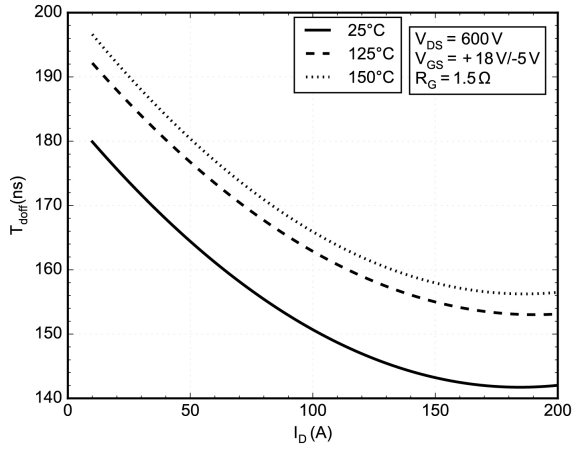

Figure 15. Typical Turn-off Switching $T_{d(off)}$ vs. I_D

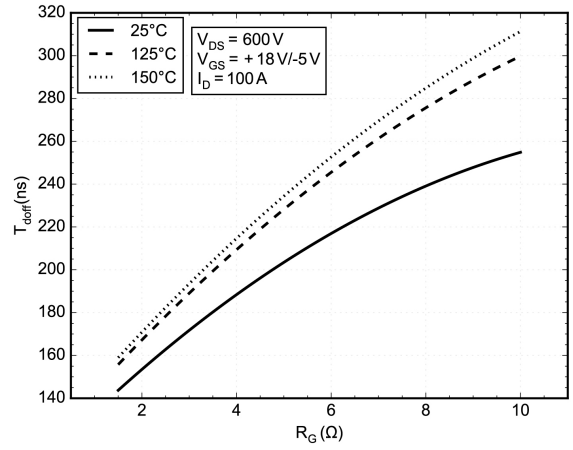

Figure 16. Typical Turn-off Switching $T_{d(off)}$ vs. R_G

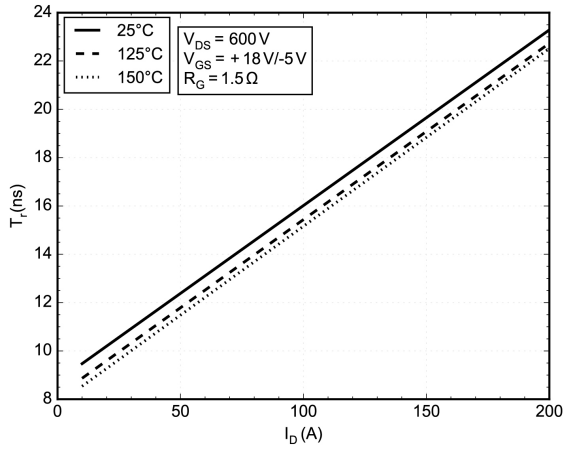

Figure 17. Typical Turn-On Switching T_r vs. I_D

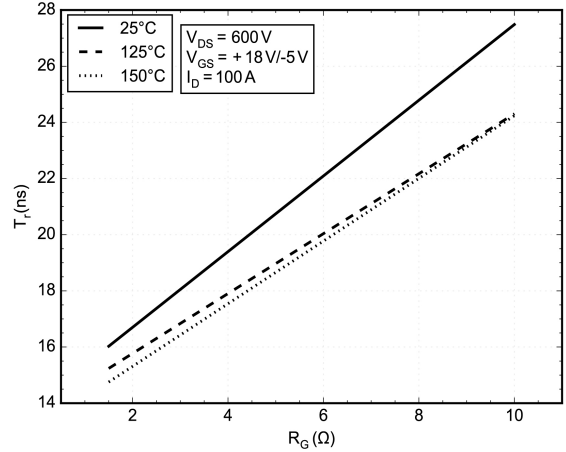

Figure 18. Typical Turn-On Switching T_r vs. R_G

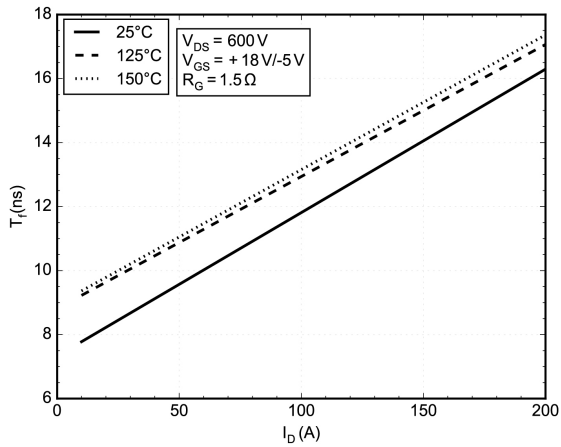

Figure 19. Typical Turn-Off Switching T_f vs. I_D

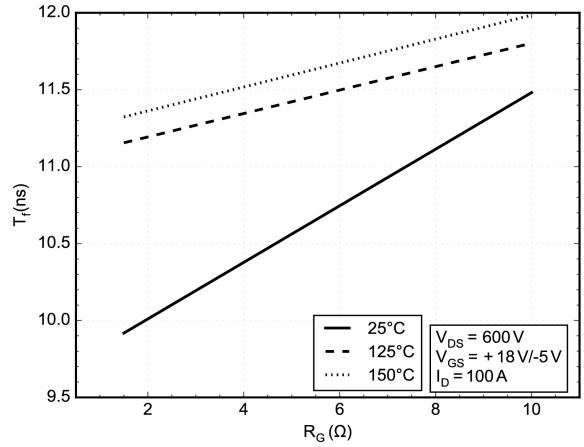

Figure 20. Typical Turn-Off Switching T_f vs. R_G

NXH010P90MNF1PTG, NXH010P90MNF1PG

TYPICAL CHARACTERISTICS

M1/M2 MOSFET SWITCHING CHARACTERISTICS

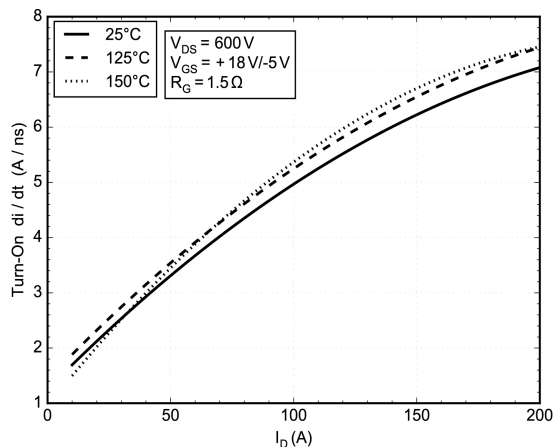

Figure 21. di/dt ON vs I_D

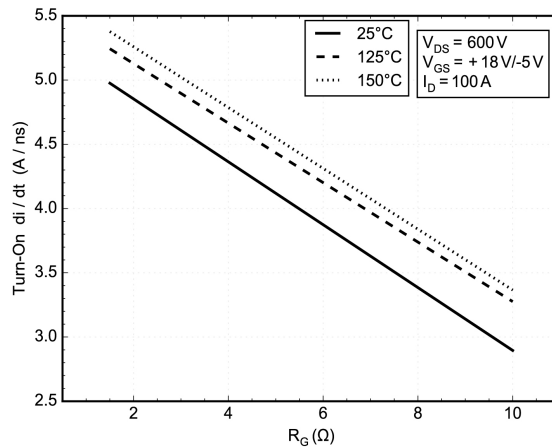

Figure 22. di/dt ON vs. R_G

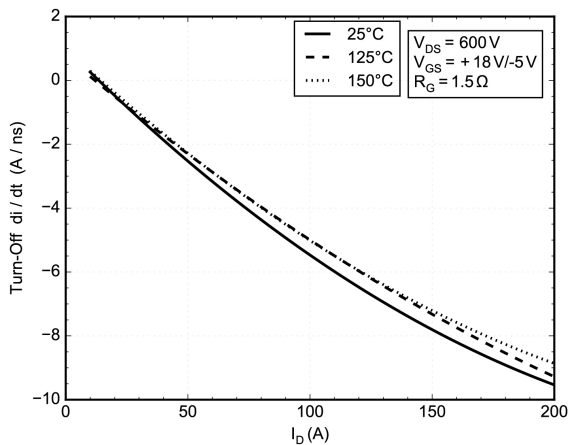

Figure 23. di/dt OFF vs I_D

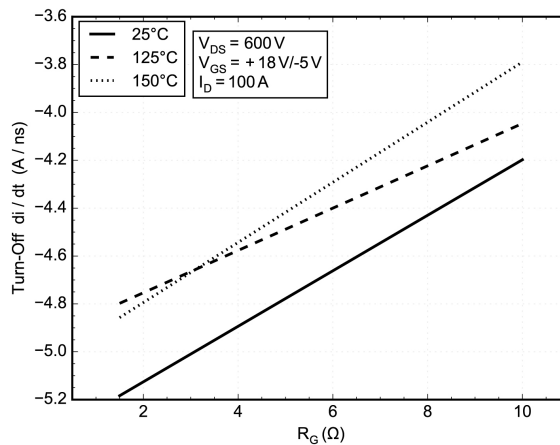

Figure 24. di/dt OFF vs. R_G

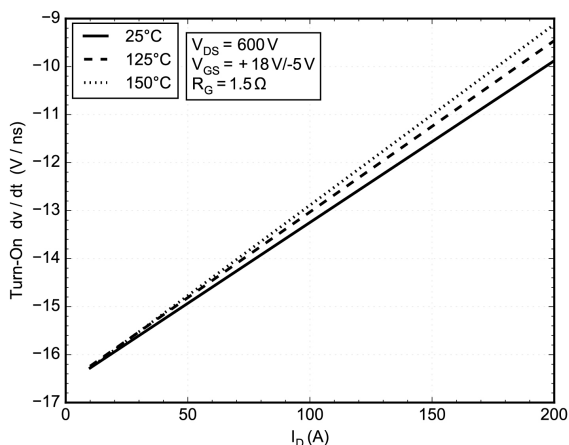

Figure 25. dv/dt ON vs I_D

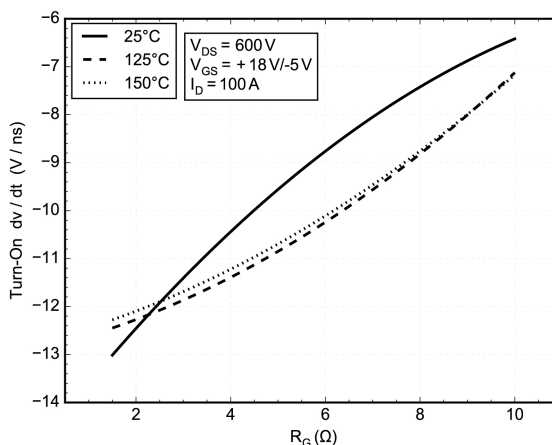

Figure 26. dv/dt ON vs. R_G

NXH010P90MNF1PTG, NXH010P90MNF1PG

TYPICAL CHARACTERISTICS
M1/M2 MOSFET SWITCHING CHARACTERISTICS

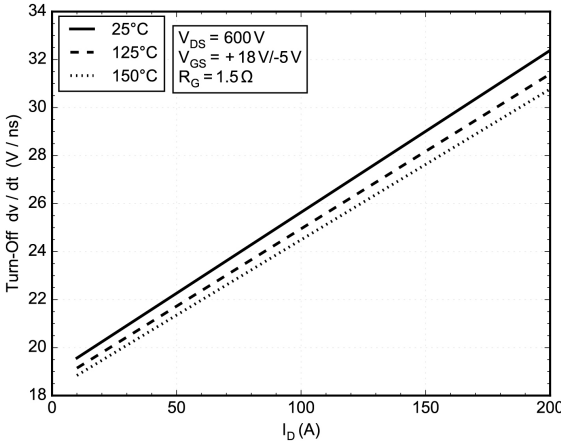

Figure 27. dv/dt OFF vs I_D

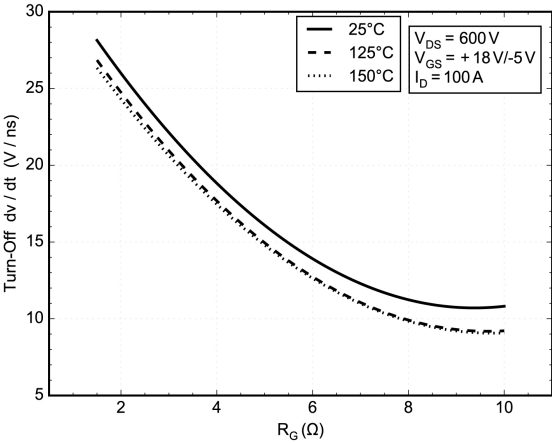

Figure 28. dv/dt OFF vs. R_G

NXH010P90MNF1PTG, NXH010P90MNF1PG

TYPICAL CHARACTERISTICS

SiC MOSFET (M1/M2)

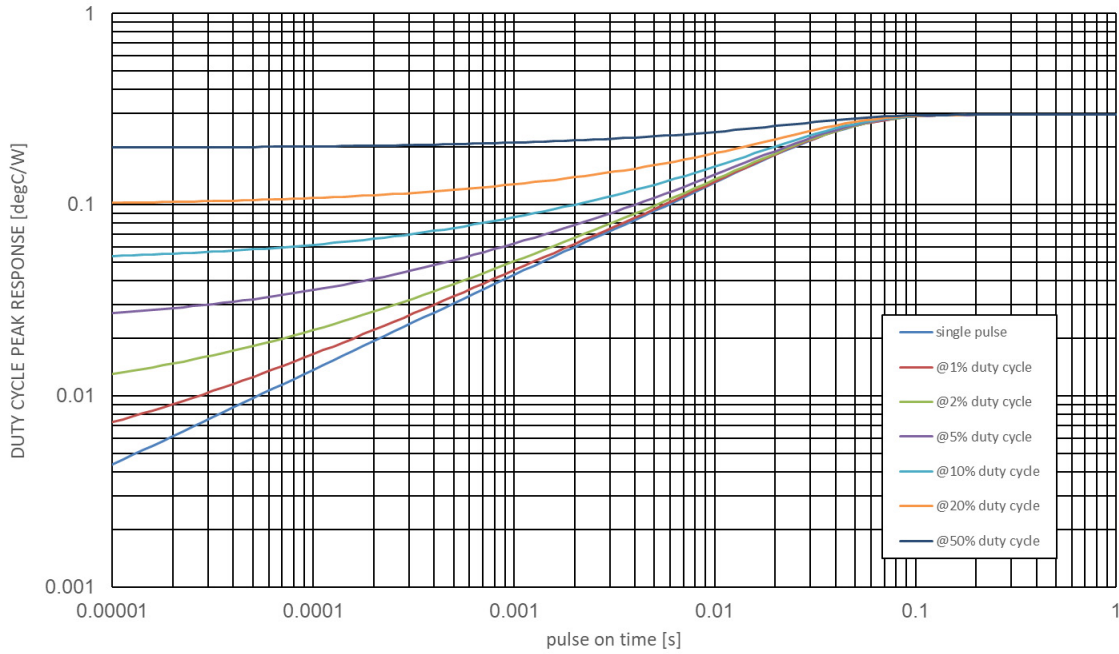

Figure 29. SiC MOSFET Junction-to-Case Transient Thermal Impedance

Table 1. FOSTER NETWORKS – M1, M2

| Foster Element # | M1 | | M2 | |
|------------------|-----------|------------|-----------|------------|
| | Rth (K/W) | Cth (Ws/K) | Rth (K/W) | Cth (Ws/K) |
| 1 | 0.018018 | 0.006761 | 0.017423 | 0.006288 |
| 2 | 0.00725 | 0.110732 | 0.008856 | 0.083472 |
| 3 | 0.007012 | 0.219934 | 0.007085 | 0.218085 |
| 4 | 0.034121 | 0.121787 | 0.035241 | 0.119517 |
| 5 | 0.227927 | 0.132429 | 0.233897 | 0.129036 |

Table 2. CAUER NETWORKS – M1, M2

| Cauer Element # | M1 | | M2 | |
|-----------------|-----------|------------|-----------|------------|
| | Rth (K/W) | Cth (Ws/K) | Rth (K/W) | Cth (Ws/K) |
| 1 | 0.025529 | 0.005642 | 0.026977 | 0.005357 |
| 2 | 0.050904 | 0.03348 | 0.070046 | 0.034112 |
| 3 | 0.066724 | 0.042125 | 0.094049 | 0.071939 |
| 4 | 0.058571 | 0.063408 | 0.040991 | 0.068148 |
| 5 | 0.092598 | 0.079724 | 0.064984 | 0.039596 |

MECHANICAL CASE OUTLINE

PACKAGE DIMENSIONS

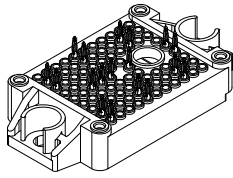

PIM18 33.8x42.5 (PRESS FIT)

CASE 180BW

ISSUE B

DATE 30 APR 2021

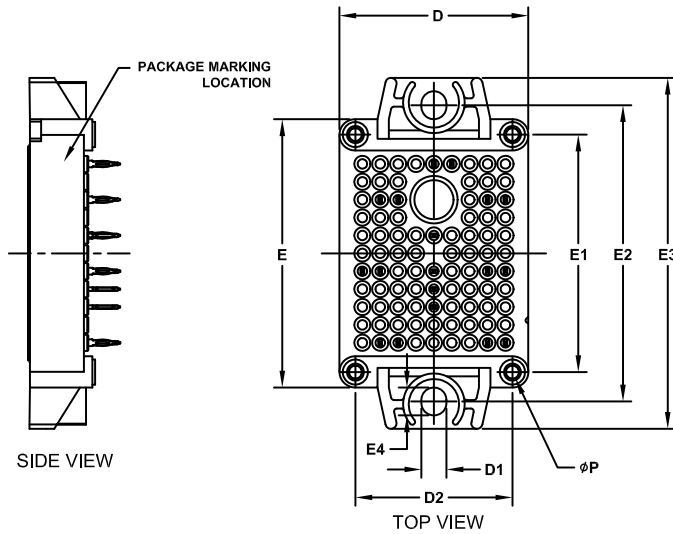

NOTES:

1. CONTROLLING DIMENSION: MILLIMETERS
2. PIN POSITION TOLERANCE IS $\pm 0.4\text{mm}$

| DIM | MILLIMETERS | | |
|-----|-------------|-------|-------|
| | MIN. | NOM. | MAX. |
| A | 11.65 | 12.00 | 12.35 |
| A1 | 16.00 | 16.50 | 17.00 |
| A2 | 0.00 | 0.35 | 0.60 |
| A3 | 12.85 | 13.35 | 13.85 |
| b | 1.15 | 1.20 | 1.25 |
| b1 | 0.59 | 0.64 | 0.69 |
| D | 33.50 | 33.80 | 34.10 |
| D1 | 4.40 | 4.50 | 4.60 |
| D2 | 27.95 | 28.10 | 28.25 |
| E | 47.70 | 48.00 | 48.30 |
| E1 | 42.35 | 42.50 | 42.65 |
| E2 | 52.90 | 53.00 | 53.10 |
| E3 | 62.30 | 62.80 | 63.30 |
| E4 | 4.90 | 5.00 | 5.10 |
| P | 2.20 | 2.30 | 2.40 |

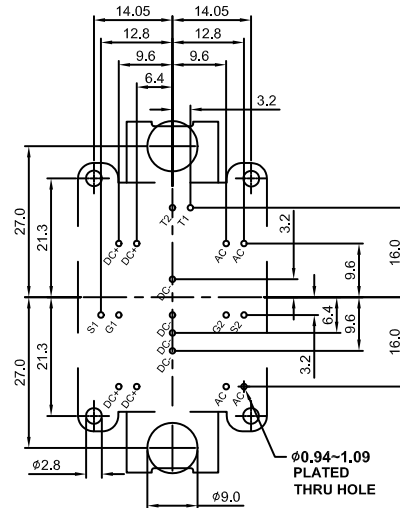
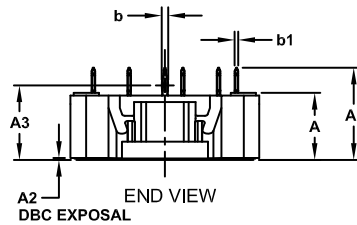

GENERIC MARKING DIAGRAM*

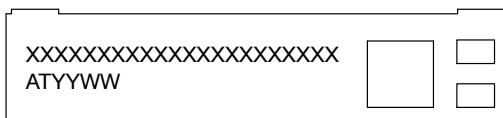

XXXXX = Specific Device Code
 AT = Assembly & Test Site Code
 YYWW = Year and Work Week Code

This information is generic. Please refer to device data sheet for actual part marking. Pb-Free indicator, "G" or microdot "", may or may not be present. Some products may not follow the Generic Marking.

| | | |
|-------------------------|------------------------------------|----------------------------------------------------------------------------------------------------------------------------------------------------------------------------------|
| DOCUMENT NUMBER: | 98AON19723H | Electronic versions are uncontrolled except when accessed directly from the Document Repository. Printed versions are uncontrolled except when stamped "CONTROLLED COPY" in red. |
| DESCRIPTION: | PIM18 33.8x42.5 (PRESS FIT) | PAGE 1 OF 1 |

onsemi and ONSEMI are trademarks of Semiconductor Components Industries, LLC dba onsemi or its subsidiaries in the United States and/or other countries. onsemi reserves the right to make changes without further notice to any products herein. onsemi makes no warranty, representation or guarantee regarding the suitability of its products for any particular purpose, nor does onsemi assume any liability arising out of the application or use of any product or circuit, and specifically disclaims any and all liability, including without limitation special, consequential or incidental damages. onsemi does not convey any license under its patent rights nor the rights of others.

onsemi, **Onsemi**, and other names, marks, and brands are registered and/or common law trademarks of Semiconductor Components Industries, LLC dba "**onsemi**" or its affiliates and/or subsidiaries in the United States and/or other countries. **onsemi** owns the rights to a number of patents, trademarks, copyrights, trade secrets, and other intellectual property. A listing of **onsemi**'s product/patent coverage may be accessed at www.onsemi.com/site/pdf/Patent-Marking.pdf. **onsemi** reserves the right to make changes at any time to any products or information herein, without notice. The information herein is provided "as-is" and **onsemi** makes no warranty, representation or guarantee regarding the accuracy of the information, product features, availability, functionality, or suitability of its products for any particular purpose, nor does **onsemi** assume any liability arising out of the application or use of any product or circuit, and specifically disclaims any and all liability, including without limitation special, consequential or incidental damages. Buyer is responsible for its products and applications using **onsemi** products, including compliance with all laws, regulations and safety requirements or standards, regardless of any support or applications information provided by **onsemi**. "Typical" parameters which may be provided in **onsemi** data sheets and/or specifications can and do vary in different applications and actual performance may vary over time. All operating parameters, including "Typicals" must be validated for each customer application by customer's technical experts. **onsemi** does not convey any license under any of its intellectual property rights nor the rights of others. **onsemi** products are not designed, intended, or authorized for use as a critical component in life support systems or any FDA Class 3 medical devices or medical devices with a same or similar classification in a foreign jurisdiction or any devices intended for implantation in the human body. Should Buyer purchase or use **onsemi** products for any such unintended or unauthorized application, Buyer shall indemnify and hold **onsemi** and its officers, employees, subsidiaries, affiliates, and distributors harmless against all claims, costs, damages, and expenses, and reasonable attorney fees arising out of, directly or indirectly, any claim of personal injury or death associated with such unintended or unauthorized use, even if such claim alleges that **onsemi** was negligent regarding the design or manufacture of the part. **onsemi** is an Equal Opportunity/Affirmative Action Employer. This literature is subject to all applicable copyright laws and is not for resale in any manner.

ADDITIONAL INFORMATION

TECHNICAL PUBLICATIONS:

Technical Library: www.onsemi.com/design/resources/technical-documentation
onsemi Website: www.onsemi.com

ONLINE SUPPORT: www.onsemi.com/support

For additional information, please contact your local Sales Representative at www.onsemi.com/support/sales

Mouser Electronics

Authorized Distributor

Click to View Pricing, Inventory, Delivery & Lifecycle Information:

[onsemi:](#)

[NXH010P90MNF1PG](#) [NXH010P90MNF1PTG](#)