

IntelliMAX™ Advanced Load Management Products

FPF2000 - FPF2007

General Description

The FPF2000 through FPF2007 is a family of load switches which provide full protection to systems and loads which may encounter large current conditions. These devices contain a 0.7 Ω current-limited P-channel MOSFET which can operate over an input voltage range of 1.8 – 5.5 V. Switch control is by a logic input (ON) capable of interfacing directly with low voltage control signals. Each part contains thermal shutdown protection which shuts off the switch to prevent damage to the part when a continuous over-current condition causes excessive heating.

When the switch current reaches the current limit, the part operates in a constant current mode to prohibit excessive currents from causing damage. For the FPF2000 – FPF2002 and FPF2004 – FPF2006, if the constant current condition still persists after 10ms, these parts will shut off the switch and pull the fault signal pin (FLAGB) low. The FPF2000, FPF2001, FPF2004 and FPF2005, have an auto-restart feature which will turn the switch on again after 80 ms if the ON pin is still active. The FPF2002 and FPF2006 do not have this auto-restart feature so the switch will remain off until the ON pin is cycled. For the FPF2003 and FPF2007, a current limit condition will immediately pull the fault signal pin low and the part will remain in the constant-current mode until the switch current falls below the current limit. For the FPF2000 through FPF2003, the minimum current limit is 50 mA while that for the FPF2004 through FPF2007 is 100 mA.

These parts are available in a space-saving 5 pin SC-70 package.

Features

- 1.8 to 5.5 V Input Voltage Range
- Controlled Turn-On
- 50 mA and 100 mA Current Limit Options
- Undervoltage Lockout
- Thermal Shutdown
- <1 μ A Shutdown Current
- Auto Restart
- Fast Current Limit Response Time
 - ◆ 3 μ s to Moderate Over Currents
 - ◆ 20 ns to Hard Shorts
- Fault Blanking+
- These Devices are Pb-Free and are RoHS Compliant



ON Semiconductor®

www.onsemi.com

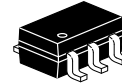

SC-88A (SC-70 5 Lead), 1.25x2
CASE 419AC-01

MARKING DIAGRAM

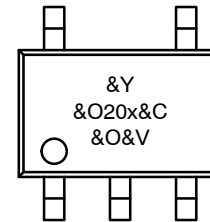

- 20x = Device Code (x = 0, 1, 2, 3, 4, 5, 6, 7)
&Y = Binary Calendar Year Coding Scheme
&O = Plant Code Identifier on Tiny Logic Package
&C = Single Digit Die Run Code
&V = Eight-Week Binary Datacoding Scheme

ORDERING INFORMATION

See detailed ordering and shipping information on page 2 of this data sheet.

Applications

- PDAs
- Cell Phones
- GPS Devices
- MP3 Players
- Digital Cameras
- Peripheral Ports
- Hot Swap Supplies

FPF2000 – FPF2007

ORDERING INFORMATION

Part	Current Limit (mA)	Current Limit Blanking Time (ms)	Auto-Restart Time (ms)	ON Pin Activity	Top Mark
FPF2000	50	10	80	Active HI	200
FPF2001	50	10	80	Active LO	201
FPF2002	50	10	NA	Active HI	202
FPF2003	50	0	NA	Active HI	203
FPF2004	100	10	80	Active HI	204
FPF2005	100	10	80	Active LO	205
FPF2006	100	10	NA	Active HI	206
FPF2007	100	0	NA	Active HI	207

TYPICAL APPLICATION CIRCUIT

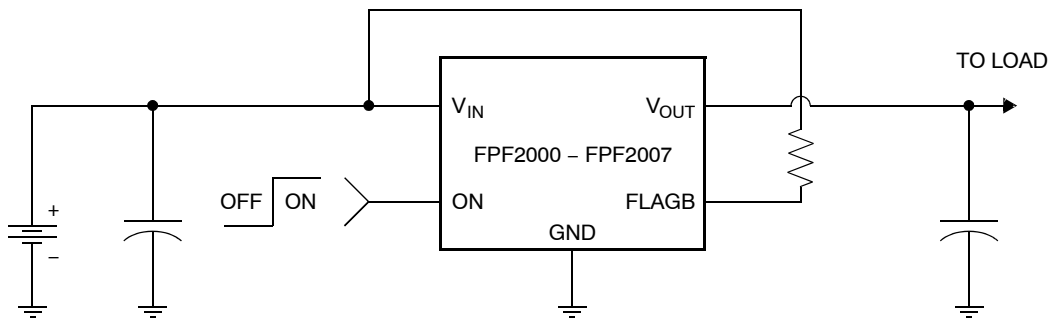

Figure 1. Typical Application Circuit

FUNCTIONAL BLOCK DIAGRAM

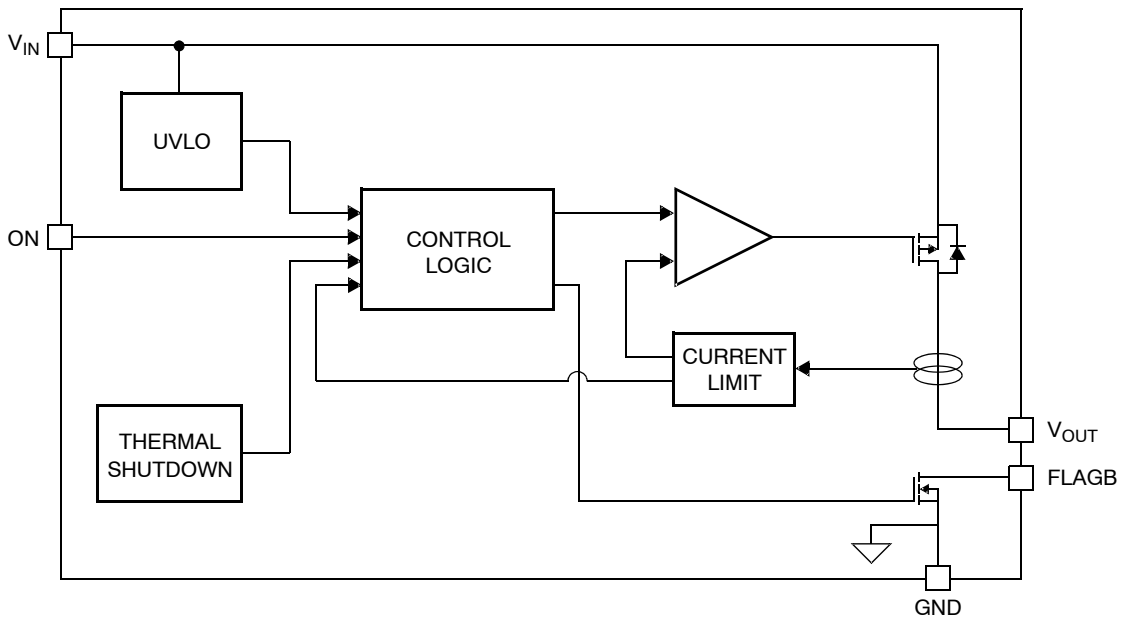

Figure 2. Functional Block Diagram

FPF2000 – FPF2007

PIN CONFIGURATION

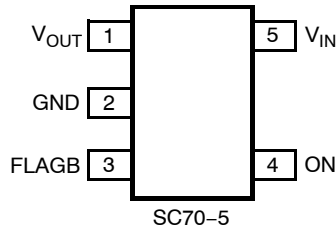

Figure 3. Pin Configuration

PIN DESCRIPTION

Pin	Name	Function
1	V _{OUT}	Switch Output: Output of the power switch
2	GND	Ground
3	FLAGB	Fault Output: Active LO, open drain output which indicates an over current, supply under voltage or over temperature state.
4	ON	On Control Input
5	V _{IN}	Supply Input: Input to the power switch and the supply voltage for the IC

ABSOLUTE MAXIMUM RATINGS

Parameter	Min	Max	Unit
V _{IN} , V _{OUT} , ON, FLAGB to GND	-0.3	6	V
Power Dissipation @ T _A = 25°C (Note 1)	-	250	mW
Operating Junction Temperature	-40	125	°C
Storage Temperature	-65	150	°C
Thermal Resistance, Junction to Ambient	-	400	°C/W
Electrostatic Discharge Protection	HBM	4000	V
	MM	400	V

Stresses exceeding those listed in the Maximum Ratings table may damage the device. If any of these limits are exceeded, device functionality should not be assumed, damage may occur and reliability may be affected.

1. Package power dissipation on 1 square inch pad, 2 oz. copper board.

RECOMMENDED OPERATING CONDITIONS

Parameter	Min	Max	Unit
V _{IN}	1.8	5.5	V
Ambient Operating Temperature, T _A	-40	85	°C

Functional operation above the stresses listed in the Recommended Operating Ranges is not implied. Extended exposure to stresses beyond the Recommended Operating Ranges limits may affect device reliability.

FPF2000 – FPF2007

ELECTRICAL CHARACTERISTICS ($V_{IN} = 1.8$ to 5.5 V, $T_A = -40$ to $+85^\circ\text{C}$ unless otherwise noted. Typical values are at $V_{IN} = 3.3$ V and $T_A = 25^\circ\text{C}$.)

Parameter	Symbol	Conditions	Min	Typ	Max	Unit	
BASIC OPERATION							
Operating Voltage	V_{IN}		1.8	–	5.5	V	
Quiescent Current	I_Q	$I_{OUT} = 0$ mA V_{ON} active	$V_{IN} = 1.8$ to 3.3 V	–	60	–	μA
			$V_{IN} = 3.3$ to 5.5 V	–	–	100	
Shutdown Current	I_{SHDN}		–	–	1	μA	
Latch-Off Current (Note 2)	$I_{LATCHOFF}$	$V_{ON} = V_{IN}$, after an overcurrent fault	–	40	–	μA	
On-Resistance	R_{ON}	$V_{IN} = 3.3$ V, $I_{OUT} = 20$ mA, $T_A = 25^\circ\text{C}$	–	0.7	1	Ω	
		$V_{IN} = 3.3$ V, $I_{OUT} = 20$ mA, $T_A = 85^\circ\text{C}$	–	0.85	1.2		
		$V_{IN} = 3.3$ V, $I_{OUT} = 20$ mA, $T_A = -40^\circ\text{C}$ to $+85^\circ\text{C}$	0.27	–	1.2		
ON Input Logic High Voltage	V_{IH}	$V_{IN} = 1.8$ V	0.8	–	–	V	
		$V_{IN} = 5.5$ V	1.5	–	–		
ON Input Logic Low Voltage	V_{IL}	$V_{IN} = 1.8$ V	–	–	0.5	V	
		$V_{IN} = 5.5$ V	–	–	0.9		
ON Input Leakage		$V_{ON} = V_{IN}$ or GND	–	–	1	μA	
Off Switch Leakage	I_{SWOFF}	$V_{ON} = 0$ V, $V_{OUT} = 0$ V @ $V_{IN} = 5.5$ V, $T_A = 85^\circ\text{C}$	–	–	1	μA	
		$V_{ON} = 0$ V, $V_{OUT} = 0$ V @ $V_{IN} = 3.3$ V, $T_A = 25^\circ\text{C}$	–	10	100	nA	
FLAGB Output Logic Low Voltage		$V_{IN} = 5$ V, $I_{SINK} = 10$ mA	–	0.1	0.2	V	
		$V_{IN} = 1.8$ V, $I_{SINK} = 10$ mA	–	0.1	0.3		
FLAGB Output High Leakage Current		$V_{IN} = 5$ V, Switch on	–	–	1	μA	

PROTECTIONS

Current Limit	I_{LIM}	$V_{IN} = 3.3$ V, $V_{OUT} = 3.0$ V	FPF2000, FPF2001, FPF2002, FPF2003	50	75	100	mA
			FPF2004, FPF2005, FPF2006, FPF2007	100	150	200	
Thermal Shutdown		Shutdown Threshold		–	140	–	$^\circ\text{C}$
		Return from Shutdown		–	130	–	
		Hysteresis		–	10	–	
Under Voltage Shutdown	UVLO	V_{IN} Increasing	1.5	1.6	1.7	V	
Under Voltage Shutdown Hysteresis			–	50	–	mV	

DYNAMIC

Turn On Time	t_{ON}	$R_L = 500$ Ω , $C_L = 0.1$ μF	–	50	–	μs
Turn Off Time	t_{OFF}	$R_L = 500$ Ω , $C_L = 0.1$ μF	–	0.5	–	μs
V_{OUT} Rise Time	t_R	$R_L = 500$ Ω , $C_L = 0.1$ μF	–	10	–	μs
V_{OUT} Fall Time	t_F	$R_L = 500$ Ω , $C_L = 0.1$ μF	–	0.1	–	μs
Over Current Blanking Time	t_{BLANK}	FPF2000, FPF2001, FPF2002, FPF2004, FPF2005, FPF2006	5	10	20	ms
Auto-Restart Time	t_{RSTRT}	FPF2000, FPF2001, FPF2004, FPF2005	40	80	160	ms
Short Circuit Response Time		$V_{IN} = V_{ON} = 3.3$ V. Moderate Over-Current Condition.	–	3	–	μs
		$V_{IN} = V_{ON} = 3.3$ V. Hard Short.	–	20	–	ns

Product parametric performance is indicated in the Electrical Characteristics for the listed test conditions, unless otherwise noted. Product performance may not be indicated by the Electrical Characteristics if operated under different conditions.

2. Applicable only to FPF2002 and FPF2006. Latchoff current does not include current flowing into FLAGB.

TYPICAL CHARACTERISTICS

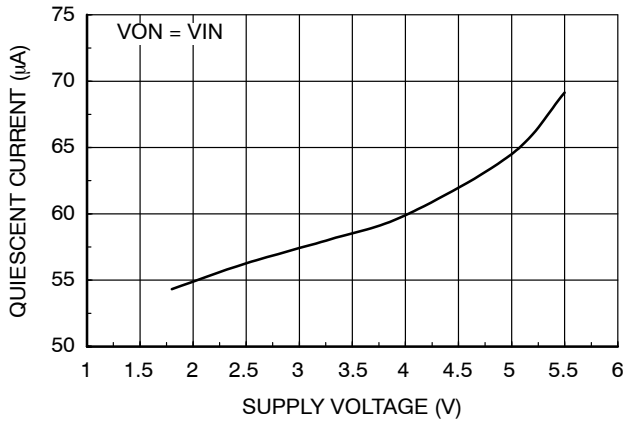

Figure 4. Quiescent Current vs. Input Voltage

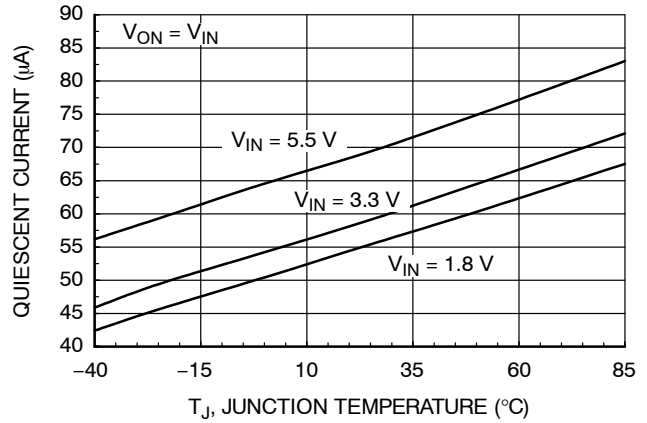

Figure 5. Quiescent Current vs. Temperature

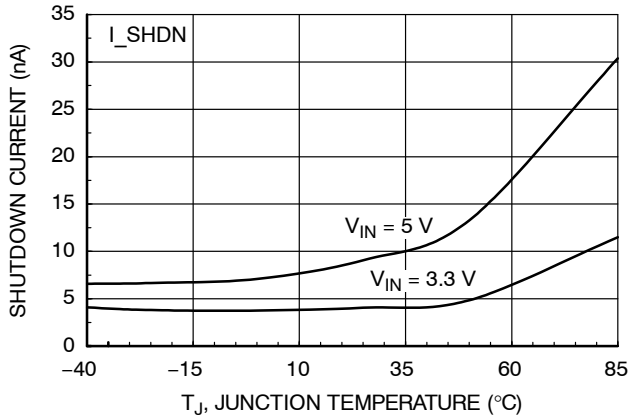

Figure 6. I_{SHUTDOWN} Current vs. Temperature

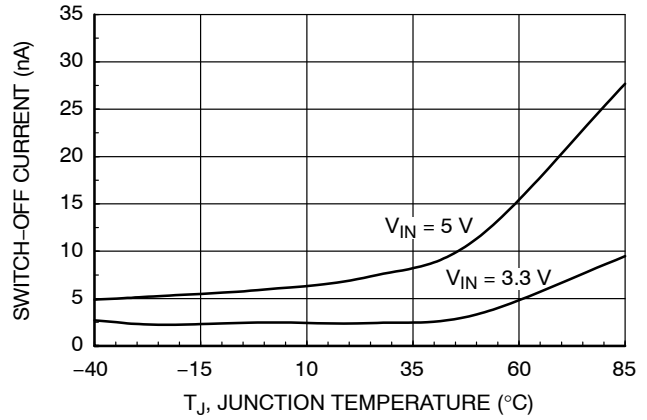

Figure 7. I_{SWITCH-OFF} Current vs. Temperature

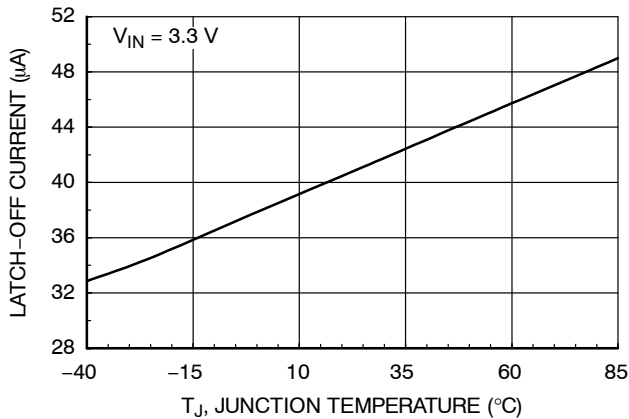

Figure 8. I_{LATCHOFF} vs. Temperature

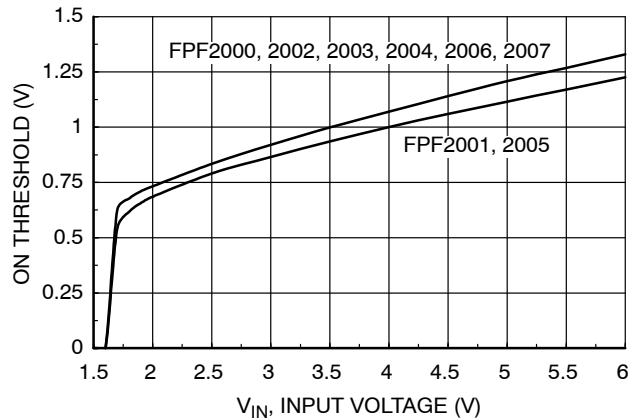

Figure 9. V_{IH} vs. V_{IN}

FPF2000 – FPF2007

TYPICAL CHARACTERISTICS (continued)

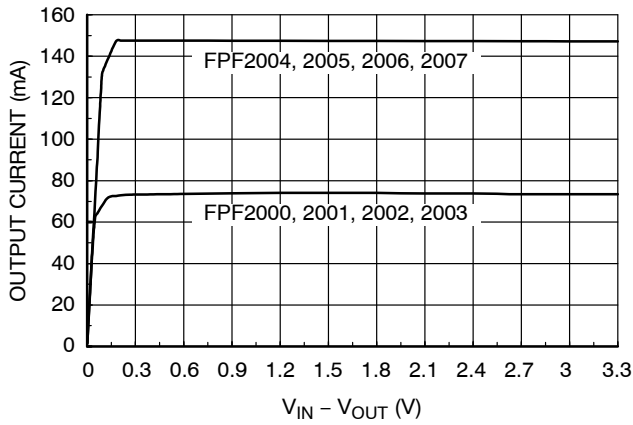

Figure 10. Current Limit vs. Output Voltage

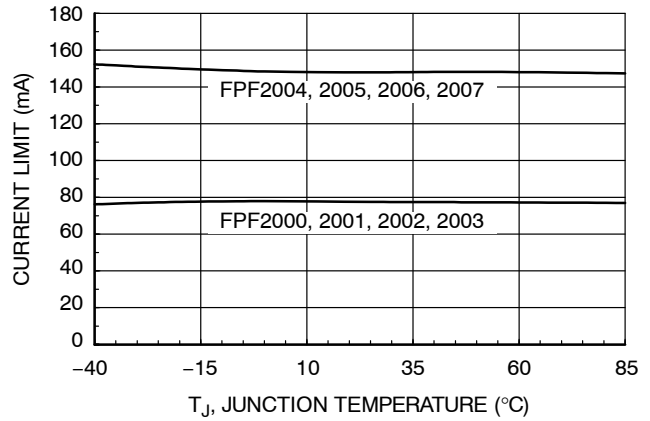

Figure 11. Current Limit vs. Temperature

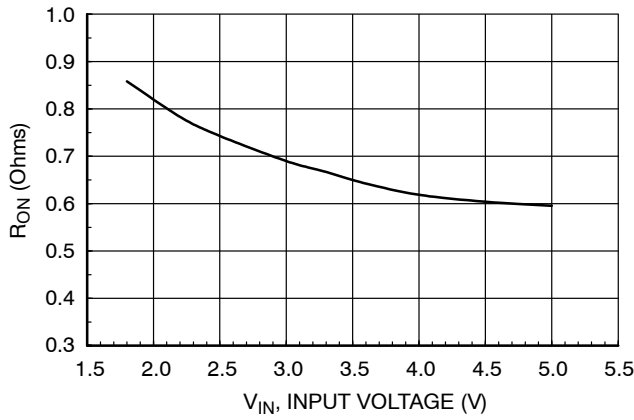

Figure 12. R_{ON} vs. V_{IN}

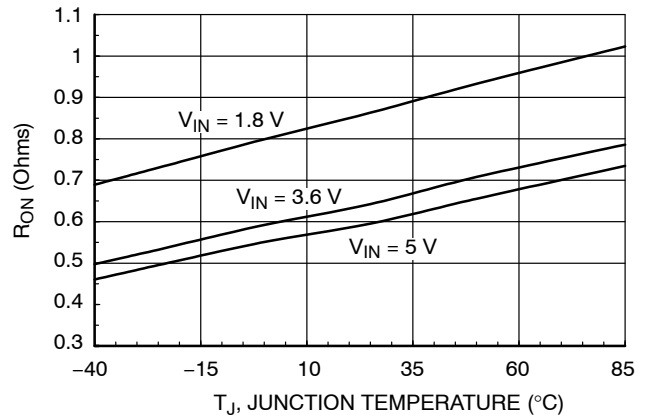

Figure 13. R_{ON} vs. Temperature

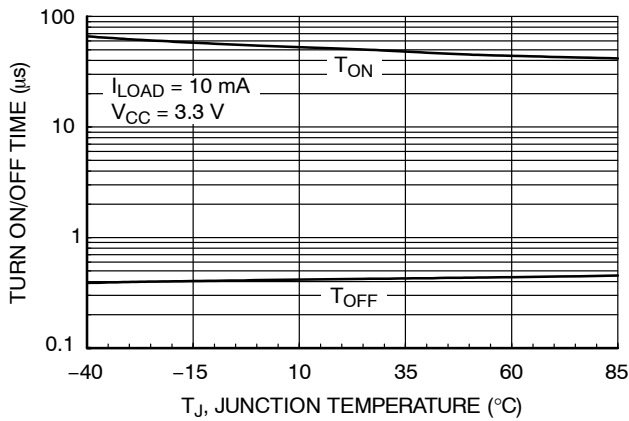

Figure 14. T_{ON}/T_{OFF} vs. Temperature

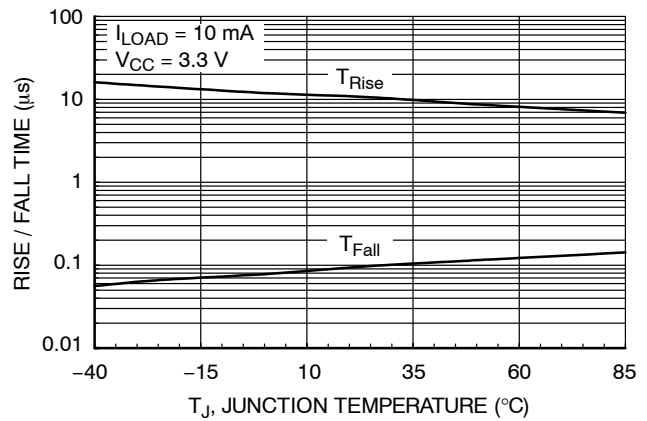

Figure 15. T_{RISE}/T_{FALL} vs. Temperature

TYPICAL CHARACTERISTICS (continued)

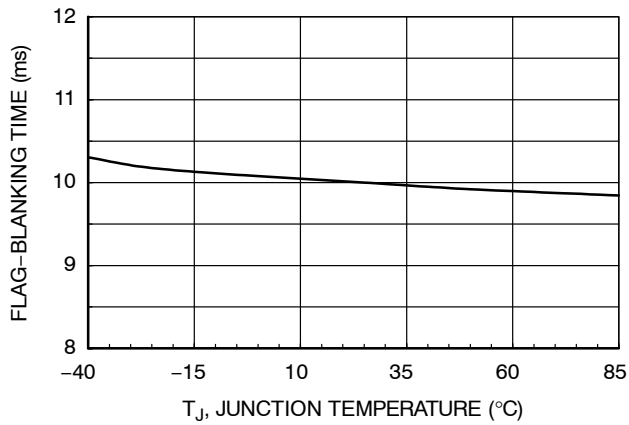

Figure 16. T_{BLANK} vs. Output Voltage

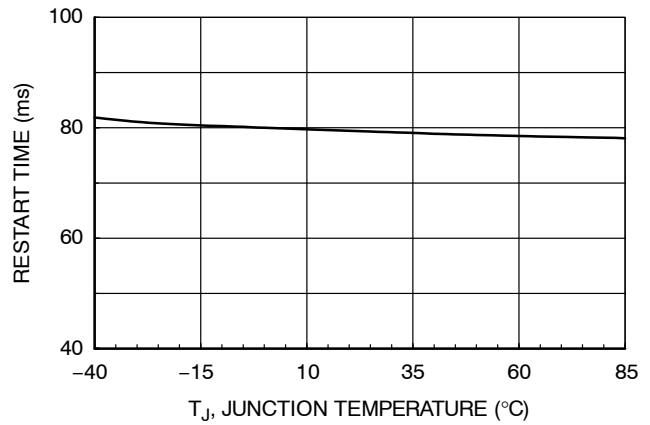

Figure 17. T_{RESTART} vs. Temperature

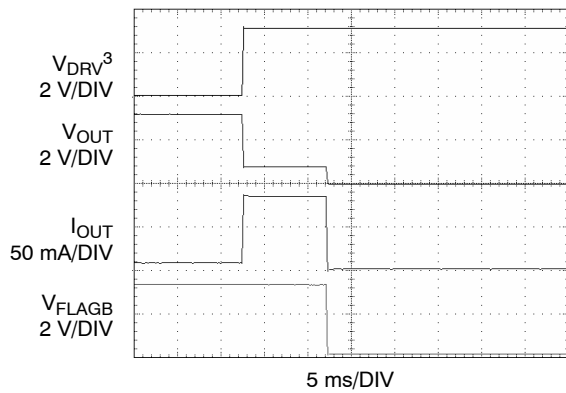

Figure 18. T_{BLANK} Response

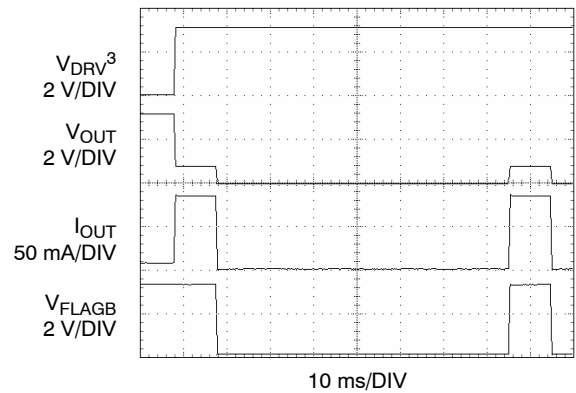

Figure 19. T_{RESTART} Response

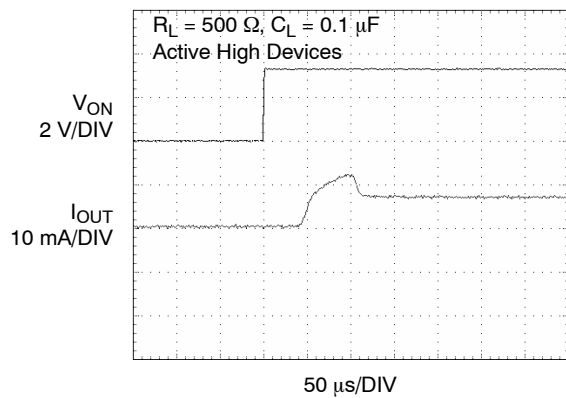

Figure 20. T_{ON} Response

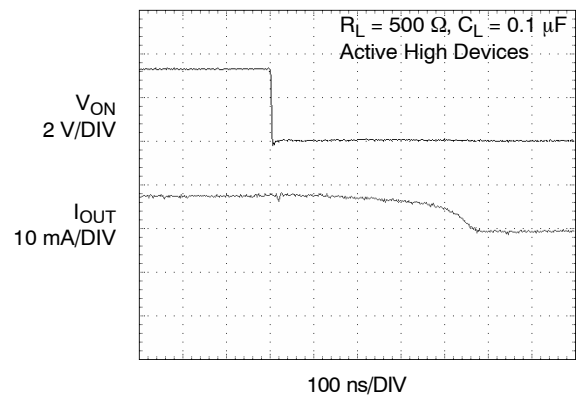

Figure 21. T_{OFF} Response

TYPICAL CHARACTERISTICS (continued)

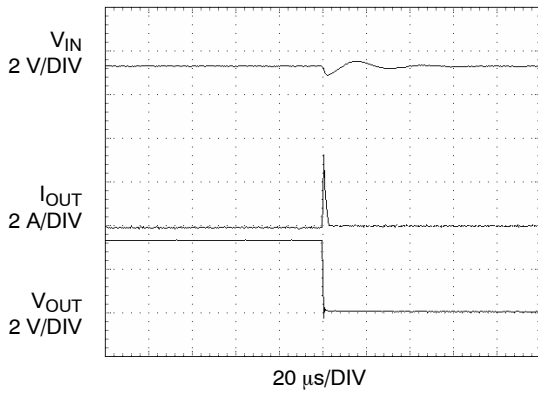

Figure 22. Short Circuit Response Time (Output Shorted to GND)

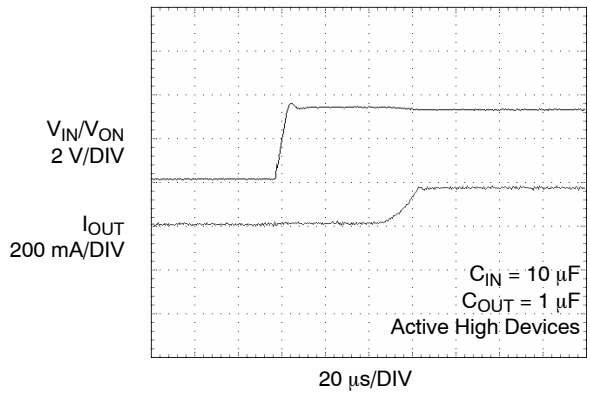

Figure 23. Current Limit Response (Switch Power Up to Hard Short)

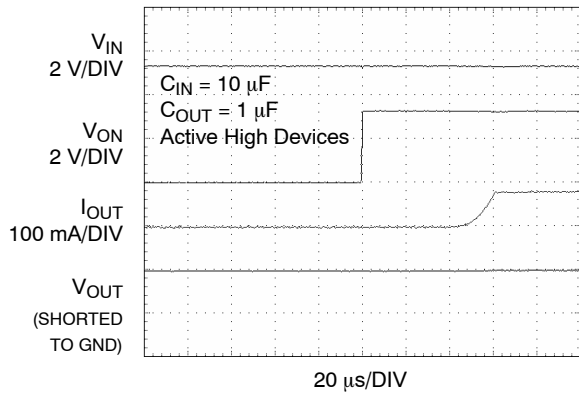

Figure 24. Current Limit Response Time

NOTE:

3. VDRV signal forces the device to go into overcurrent condition.

DESCRIPTION OF OPERATION

The FPF2000 – FPF2007 are current limited switches that protect systems and loads which can be damaged or disrupted by the application of high currents. The core of each device is a $0.7\ \Omega$ P-channel MOSFET and a controller capable of functioning over a wide input operating range of 1.8 – 5.5 V. The controller protects against system malfunctions through current limiting, under-voltage lockout and thermal shutdown. The current limit is preset for either 50 mA or 100 mA.

On/Off Control

The ON pin controls the state of the switch. Active HI and LO versions are available. Refer to the Ordering Information for details. Activating ON continuously holds the switch in the on state so long as there is no fault. For all versions, an under-voltage on VIN or a junction temperature in excess of 150°C overrides the ON control to turn off the switch. In addition, excessive currents will cause the switch to turn off in FPF2000 – FPF2002 and FPF2004 – FPF2007. The FPF2000, FPF2001, FPF2004 and FPF2005 have an Auto-Restart feature which will automatically turn the switch on again after 80 ms. For the FPF2002 and FPF2006, the ON pin must be toggled to turn-on the switch again. The FPF2003 and FPF2007 do not turn off in response to a over current condition but instead remain operating in a constant current mode so long as ON is active and the thermal shutdown or under-voltage lockout have not activated.

Fault Reporting

Upon the detection of an over-current, an input under-voltage, or an over-temperature condition, the FLAGB signals the fault mode by activating LO. For the FPF2000 – FPF2002 and FPF2004 – FPF2006, the FLAGB goes LO at the end of the blanking time while FLAGB goes LO immediately for the FPF2003 and FPF2007. FLAGB remains LO through the Auto-Restart Time for the FPF2000, FPF2001 FPF2004 and FPF2005. For the FPF2002 and FPF2006, FLAGB is latched LO and ON must be toggled to release it. With the FPF2003 and FPF2007, FLAGB is LO during the faults and immediately returns HI at the end of the fault condition. FLAGB is an open-drain

MOSFET which requires a pull-up resistor between VIN and FLAGB. During shutdown, the pull-down on FLAGB is disabled to reduce current draw from the supply.

Current Limiting

The current limit ensures that the current through the switch doesn't exceed a maximum value while not limiting at less than a minimum value. For the FPF2000 – FPF2003 the minimum current is 50 mA and the maximum current is 100 mA and for the FPF2004 – FPF2007 the minimum current is 100 mA and the maximum current is 200 mA. The FPF2000 – FPF2002 and the FPF2004 – FPF2006, have a blanking time of 10 ms, nominally, during which the switch will act as a constant current source. At the end of the blanking time, the switch will be turned-off and the FLAGB pin will activate to indicate that current limiting has occurred. The FPF2003 and FPF2007 have no current limit blanking period so immediately upon a current limit condition FLAGB is activated. These parts will remain in a constant current state until the ON pin is deactivated or the thermal shutdown turns-off the switch.

Reverse Voltage

If the voltage at the VOUT pin is larger than the VIN pin, large currents may flow and can cause permanent damage to the device. FPF2000 – FPF2007 is designed to control current flow from VIN to VOUT.

Under-Voltage Lockout

The under-voltage lockout turns-off the switch if the input voltage drops below the under-voltage lockout threshold. With the ON pin active the input voltage rising above the under-voltage lockout threshold will cause a controlled turn-on of the switch which limits current over-shoots.

Thermal Shutdown

The thermal shutdown protects the die from internally or externally generated excessive temperatures. During an over-temperature condition the FLAGB is activated and the switch is turned-off. The switch automatically turns-on again if temperature of the die drops below the threshold temperature.

APPLICATION INFORMATION

Typical Application

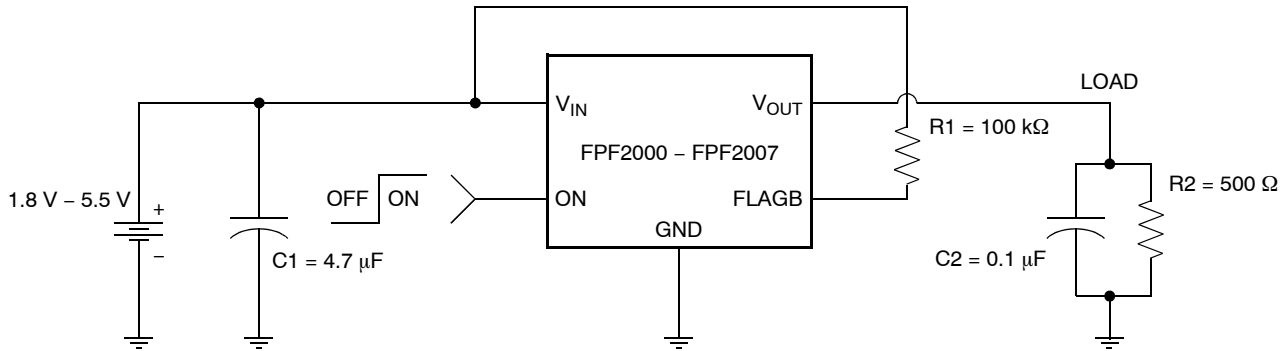

Figure 25. Typical Application

Input Capacitor

To limit the voltage drop on the input supply caused by transient in-rush currents when the switch turns-on into a discharged load capacitor or a short-circuit, a capacitor needs to be placed between V_{IN} and GND. A 4.7 μF ceramic capacitor, C_{IN} , must be placed close to the V_{IN} pin. A higher value of C_{IN} can be used to further reduce the voltage drop experienced as the switch is turned on into a large capacitive load.

Output Capacitor

A 0.1 μF capacitor C_{OUT} , should be placed between V_{OUT} and GND. This capacitor will prevent parasitic board inductances from forcing V_{OUT} below GND when the switch turns-off. For the FPF2000 – FPF2002 and the FPF2004 – FPF2006, the total output capacitance needs to be kept below a maximum value, $C_{OUT(max)}$, to prevent the part from registering an over-current condition and turning-off the switch. The maximum output capacitance can be determined from the following formula,

$$C_{OUT} = \frac{I_{LIM(max)} \times t_{BLANK(min)}}{V_{IN}} \quad (\text{eq. 1})$$

Due to the integral body diode in the PMOS switch, a C_{IN} greater than C_{OUT} is highly recommended. A C_{OUT} greater than C_{IN} can cause V_{OUT} to exceed V_{IN} when the system supply is removed. This could result in current flow through the body diode from V_{OUT} to V_{IN} .

Power Dissipation

During normal operation as a switch, the power dissipation is small and has little effect on the operating temperature of the part. The parts with the higher current limits will dissipate the most power and that will only be,

$$P = (I_{LIM})^2 \times R_{DS} = (0.2)^2 \times 0.7 = 28 \text{ mW} \quad (\text{eq. 2})$$

If the part goes into current limit the maximum power dissipation will occur when the output is shorted to ground. For the FPF2000, FPF2001, FPF2004 and FPF2005, the power dissipation will scale by the Auto-Restart Time, $t_{RESTART}$, and the Over Current Blanking Time, t_{BLANK} , so that the maximum power dissipated is,

$$P(max) = \frac{t_{BLANK}}{t_{RESTART} + t_{BLANK}} \times (V_{IN(max)}) \times I_{LIM(max)}$$

$$= \frac{10}{80 + 10} \times 5.5 \times 0.2 = 1.22 \text{ mW} \quad (\text{eq. 3})$$

When using the FPF2002 and FPF2006 attention must be given to the manual resetting of the part. Continuously resetting the part at a high duty cycle when a short on the output is present can cause the temperature of the part to increase. The junction temperature will only be allowed to increase to the thermal shutdown threshold. Once this temperature has been reached, toggling ON will not turn-on the switch until the junction temperature drops. For the FPF2003 and FPF2007, a short on the output will cause the part to operate in a constant current state dissipating a worst case power as calculated in (eq. 3) until the thermal shutdown activates. It will then cycle in and out of thermal shutdown so long as the ON pin is active and the short is present.

Board Layout

For best performance, all traces should be as short as possible. To be most effective, the input and output capacitors should be placed close to the device to minimize the effects that parasitic trace inductances may have on normal and short-circuit operation. Using wide traces for V_{IN} , V_{OUT} and GND will help minimize parasitic electrical effects along with minimizing the case to ambient thermal impedance.



SC-88A (SC-70 5 Lead), 1.25x2
CASE 419AC-01
ISSUE A

DATE 29 JUN 2010

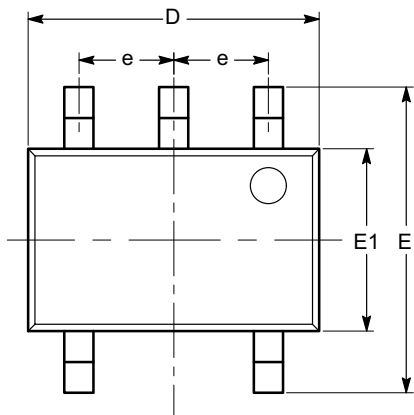

TOP VIEW

SYMBOL	MIN	NOM	MAX
A	0.80		1.10
A1	0.00		0.10
A2	0.80		1.00
b	0.15		0.30
c	0.10		0.18
D	1.80	2.00	2.20
E	1.80	2.10	2.40
E1	1.15	1.25	1.35
e	0.65 BSC		
L	0.26	0.36	0.46
L1	0.42 REF		
L2	0.15 BSC		
θ	0°		8°
θ_1	4°		10°

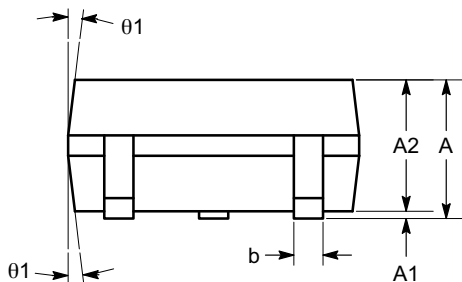

SIDE VIEW

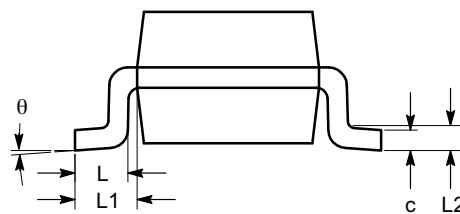

END VIEW

Notes:

- (1) All dimensions are in millimeters. Angles in degrees.
- (2) Complies with JEDEC MO-203.

DOCUMENT NUMBER:	98AON34260E	Electronic versions are uncontrolled except when accessed directly from the Document Repository. Printed versions are uncontrolled except when stamped "CONTROLLED COPY" in red.
DESCRIPTION:	SC-88A (SC-70 5 LEAD), 1.25X2	PAGE 1 OF 1

ON Semiconductor and are trademarks of Semiconductor Components Industries, LLC dba ON Semiconductor or its subsidiaries in the United States and/or other countries. ON Semiconductor reserves the right to make changes without further notice to any products herein. ON Semiconductor makes no warranty, representation or guarantee regarding the suitability of its products for any particular purpose, nor does ON Semiconductor assume any liability arising out of the application or use of any product or circuit, and specifically disclaims any and all liability, including without limitation special, consequential or incidental damages. ON Semiconductor does not convey any license under its patent rights nor the rights of others.

onsemi, **Onsemi**, and other names, marks, and brands are registered and/or common law trademarks of Semiconductor Components Industries, LLC dba "**onsemi**" or its affiliates and/or subsidiaries in the United States and/or other countries. **onsemi** owns the rights to a number of patents, trademarks, copyrights, trade secrets, and other intellectual property. A listing of **onsemi**'s product/patent coverage may be accessed at www.onsemi.com/site/pdf/Patent-Marking.pdf. **onsemi** reserves the right to make changes at any time to any products or information herein, without notice. The information herein is provided "as-is" and **onsemi** makes no warranty, representation or guarantee regarding the accuracy of the information, product features, availability, functionality, or suitability of its products for any particular purpose, nor does **onsemi** assume any liability arising out of the application or use of any product or circuit, and specifically disclaims any and all liability, including without limitation special, consequential or incidental damages. Buyer is responsible for its products and applications using **onsemi** products, including compliance with all laws, regulations and safety requirements or standards, regardless of any support or applications information provided by **onsemi**. "Typical" parameters which may be provided in **onsemi** data sheets and/or specifications can and do vary in different applications and actual performance may vary over time. All operating parameters, including "Typicals" must be validated for each customer application by customer's technical experts. **onsemi** does not convey any license under any of its intellectual property rights nor the rights of others. **onsemi** products are not designed, intended, or authorized for use as a critical component in life support systems or any FDA Class 3 medical devices or medical devices with a same or similar classification in a foreign jurisdiction or any devices intended for implantation in the human body. Should Buyer purchase or use **onsemi** products for any such unintended or unauthorized application, Buyer shall indemnify and hold **onsemi** and its officers, employees, subsidiaries, affiliates, and distributors harmless against all claims, costs, damages, and expenses, and reasonable attorney fees arising out of, directly or indirectly, any claim of personal injury or death associated with such unintended or unauthorized use, even if such claim alleges that **onsemi** was negligent regarding the design or manufacture of the part. **onsemi** is an Equal Opportunity/Affirmative Action Employer. This literature is subject to all applicable copyright laws and is not for resale in any manner.

PUBLICATION ORDERING INFORMATION

LITERATURE FULFILLMENT:

Email Requests to: orderlit@onsemi.com

onsemi Website: www.onsemi.com

TECHNICAL SUPPORT

North American Technical Support:

Voice Mail: 1 800-282-9855 Toll Free USA/Canada

Phone: 011 421 33 790 2910

Europe, Middle East and Africa Technical Support:

Phone: 00421 33 790 2910

For additional information, please contact your local Sales Representative

Mouser Electronics

Authorized Distributor

Click to View Pricing, Inventory, Delivery & Lifecycle Information:

[onsemi:](#)

[FPF2007](#) [FPF2004](#) [FPF2000](#) [FPF2002](#) [FPF2006](#) [FPF2001](#) [FPF2003](#)