

MOS FET Relays G3VM-61LR

SSOP Package MOS FET Relay with Low Leakage Current, Output Capacitance and ON Resistance ($C \times R = 20 \text{ pF} \cdot \Omega$) in a 60-V Load Voltage Model.

- ON resistance of 1 Ω (typical) suppresses output signal attenuation.
- Leakage current of 0.04 nA (typ.) when relay is open
- RoHS compliant

Application Examples

- Semiconductor inspection tools
- Measurement devices and Data loggers
- Broadband systems



NEW

Note: The actual product is marked differently from the image shown here.

List of Models

Contact form	Terminals	Load voltage (peak value)	Model	Number per tape
SPST-NO	Surface-mounting terminals	60 VAC	G3VM-61LR	---
			G3VM-61LR(TR05)	500
			G3VM-61LR(TR)	1,500

Dimensions

Note: All units are in millimeters unless otherwise indicated.

G3VM-61LR

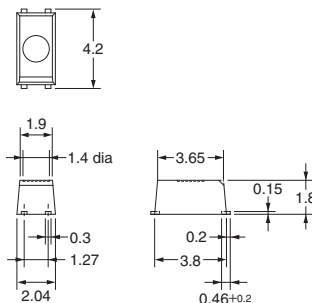
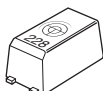

Note: The actual product is marked differently from the image shown here.

Note: A tolerance of $\pm 0.1 \text{ mm}$ applies to all dimensions unless otherwise specified.

Weight: 0.03 g

Terminal Arrangement/Internal Connections (Top View)

G3VM-61LR

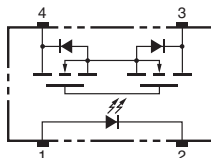

Actual Mounting Pad Dimensions (Recommended Value, Top View)

G3VM-61LR

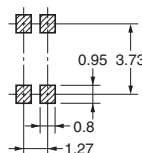

■ Absolute Maximum Ratings (Ta = 25°C)

Item		Symbol	Rating	Unit	Measurement Conditions
Input	LED forward current	I_F	50	mA	
	LED forward current reduction rate	$\Delta I_F/^\circ\text{C}$	-0.5	mA/°C	$T_a \geq 25^\circ\text{C}$
	LED reverse voltage	V_R	5	V	
	Connection temperature	T_j	125	°C	
Output	Load voltage (AC peak/DC)	V_{OFF}	60	V	
	Continuous load current	I_O	400	mA	
	ON current reduction rate	$\Delta I_{ON}/^\circ\text{C}$	-4.0	mA/°C	$T_a \geq 25^\circ\text{C}$
	Connection temperature	T_j	125	°C	
Dielectric strength between input and output (See note 1.)		V_{I-O}	1,500	V_{rms}	AC for 1 min
Ambient operating temperature		T_a	-20 to +85	°C	With no icing or condensation
Storage temperature		T_{stg}	-40 to +125	°C	With no icing or condensation
Soldering temperature		---	260	°C	10 s

Note: 1. The dielectric strength between the input and output was checked by applying voltage between all pins as a group on the LED side and all pins as a group on the light-receiving side.

■ Electrical Characteristics (Ta = 25°C)

Item		Symbol	Minimum	Typical	Maximum	Unit	Measurement conditions
Input	LED forward voltage	V_F	1.0	1.15	1.3	V	$I_F = 10 \text{ mA}$
	Reverse current	I_R	---	---	10	μA	$V_R = 5 \text{ V}$
	Capacity between terminals	C_T	---	15	---	pF	$V = 0, f = 1 \text{ MHz}$
	Trigger LED forward current	I_{FT}	---	2	5	mA	$I_O = 100 \text{ mA}, R_{ON} < 1.5 \Omega$
Output	Maximum resistance with output ON	R_{ON}	---	1.0	1.5	Ω	$I_F = 5 \text{ mA}, I_O = 400 \text{ mA}$
	Current leakage when the relay is open	I_{LEAK}	---	0.04	1,000	nA	$V_{OFF} = 60 \text{ V}, T_a = 25^\circ\text{C}$
	Capacity between terminals	C_{OFF}	---	20	---	pF	$V = 0, f = 100 \text{ MHz}, t < 1 \text{ s}$
Capacity between I/O terminals		C_{I-O}	---	0.3	---	pF	$f = 1 \text{ MHz}, V_s = 0 \text{ V}$
Insulation resistance between I/O terminals		R_{I-O}	1,000	---	---	$M\Omega$	$V_{I-O} = 500 \text{ VDC}, R_{oh} \leq 60\%$
Turn-ON time		t_{ON}	---	0.3	1	ms	$I_F = 5 \text{ mA}, R_L = 200 \Omega, V_{DD} = 20 \text{ V}$ (See note 2.)
Turn-OFF time		t_{OFF}	---	0.2	1	ms	

Note: 2. Turn-ON and Turn-OFF Times

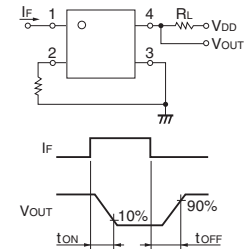

■ Recommended Operating Conditions

Use the G3VM under the following conditions so that the Relay will operate properly.

Item	Symbol	Minimum	Typical	Maximum	Unit
Load voltage (AC peak/DC)	V_{DD}	---	---	48	V
Operating LED forward current	I_F	10	---	20	mA
Continuous load current (AC peak/DC)	I_O	---	---	400	mA
Operating temperature	T_a	-20	---	70	°C

■ Engineering Data

LED forward current vs. Ambient temperature
 $I_F - T_a$

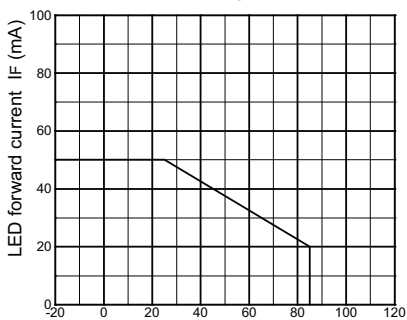

Ambient temperature T_a (°C)

Continuous load current vs. Ambient temperature
 $I_O - T_a$

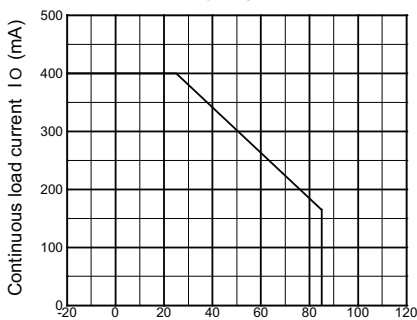

Ambient temperature T_a (°C)

LED forward current vs. LED forward voltage
 $I_F - V_F$

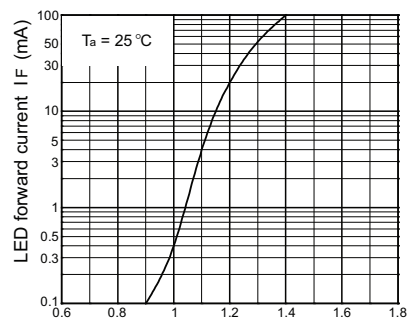

LED forward voltage V_F (V)

Continuous load current vs. On-state voltage
 $I_O - V_{ON}$

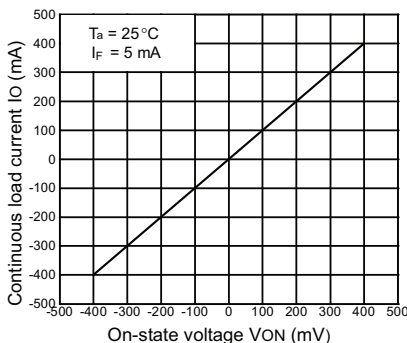

On-state voltage V_{ON} (mV)

On-state resistance vs. Ambient temperature
 $R_{ON} - T_a$

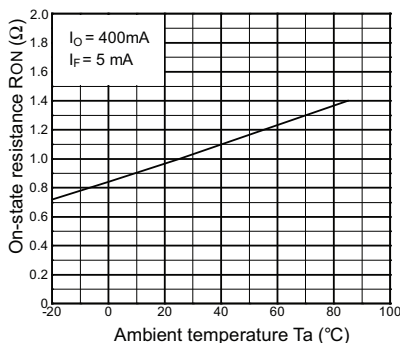

Ambient temperature T_a (°C)

Trigger LED forward current vs. Ambient temperature
 $I_{FT} - T_a$

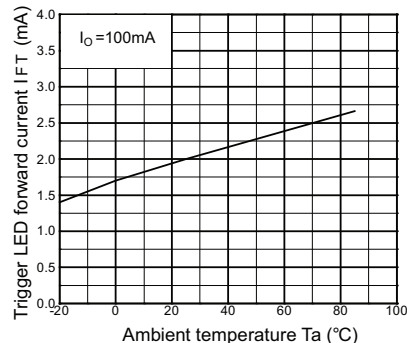

Ambient temperature T_a (°C)

Turn ON, Turn OFF time vs. LED forward current
 $t_{ON}, t_{OFF} - I_F$

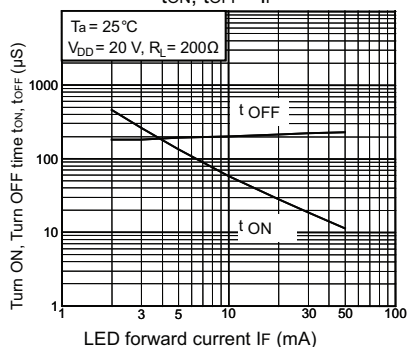

LED forward current I_F (mA)

Turn ON, Turn OFF time vs. Ambient temperature
 $t_{ON}, t_{OFF} - T_a$

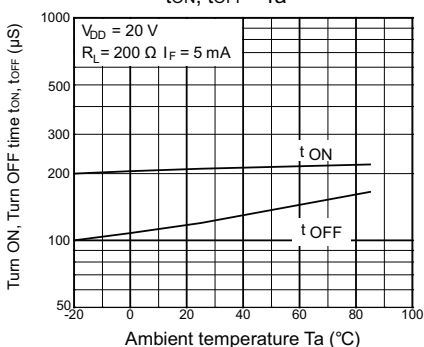

Ambient temperature T_a (°C)

Current leakage vs. Load voltage
 $I_{LEAK} - V_{OFF}$

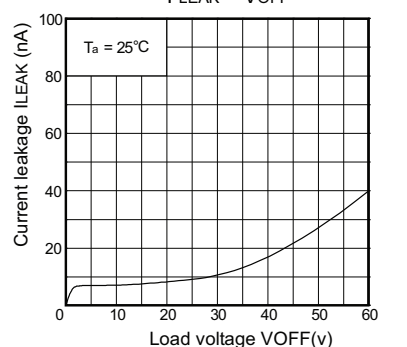

Load voltage V_{OFF} (V)

Output terminal capacitance COFF/COFF(ov) vs. Load voltage
 $COFF - V_{OFF}$

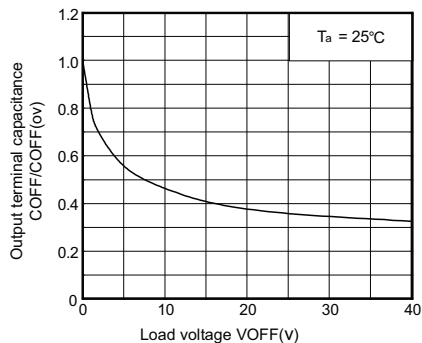

Load voltage V_{OFF} (V)

All sales are subject to Omron Electronic Components LLC standard terms and conditions of sale, which can be found at http://www.components.omron.com/components/web/webfiles.nsf/sales_terms.html

ALL DIMENSIONS SHOWN ARE IN MILLIMETERS.
To convert millimeters into inches, multiply by 0.03937. To convert grams into ounces, multiply by 0.03527.

OMRON[®]

**OMRON ELECTRONIC
COMPONENTS LLC**

55 E. Commerce Drive, Suite B
Schaumburg, IL 60173

847-882-2288

OMRON ON-LINE

Global - <http://www.omron.com>

USA - <http://www.components.omron.com>

Cat. No. X302-E-1

12/10

Specifications subject to change without notice

Printed in USA

Mouser Electronics

Authorized Distributor

Click to View Pricing, Inventory, Delivery & Lifecycle Information:

Omron:

[G3VM-61LR\(TR\)](#) [G3VM-61LR\(TR05\)](#)