

## Photomicrosensor (Reflective) EE-SY169A

**⚠ Be sure to read *Precautions* on page 24.**

### ■ Dimensions

**Note:** All units are in millimeters unless otherwise indicated.

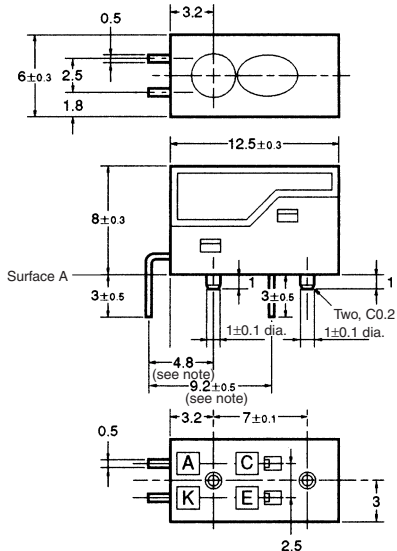

**Internal Circuit**

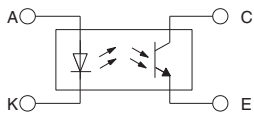

**Note:** These dimensions are for the surface A. Other lead wire pitch dimensions are for the housing surface.

Unless otherwise specified, the tolerances are as shown below.

Dimensions	Tolerance
3 mm max.	±0.3
3 < mm ≤ 6	±0.375
6 < mm ≤ 10	±0.45
10 < mm ≤ 18	±0.55
18 < mm ≤ 30	±0.65

Terminal No.	Name
A	Anode
K	Cathode
C	Collector
E	Emitter

### ■ Features

- High-quality model with plastic lenses.
- Highly precise sensing range with a tolerance of ±0.6 mm horizontally and vertically.
- Convergent reflective model with infrared LED.
- Recommended sensing distance = 4.0 mm

### ■ Absolute Maximum Ratings (Ta = 25°C)

Item	Symbol	Rated value
Emitter	Forward current	$I_F$ 50 mA (see note 1)
	Pulse forward current	$I_{FP}$ 1 A (see note 2)
	Reverse voltage	$V_R$ 3 V
Detector	Collector–Emitter voltage	$V_{CEO}$ 30 V
	Emitter–Collector voltage	$V_{ECO}$ ---
	Collector current	$I_C$ 20 mA
	Collector dissipation	$P_C$ 100 mW (see note 1)
Ambient temperature	Operating	$T_{opr}$ 0°C to 70°C
	Storage	$T_{stg}$ -20°C to 80°C
Soldering temperature	$T_{sol}$	260°C (see note 3)

- Note:**
1. Refer to the temperature rating chart if the ambient temperature exceeds 25°C.
  2. The pulse width is 10 μs maximum with a frequency of 100 Hz.
  3. Complete soldering within 10 seconds.

### ■ Electrical and Optical Characteristics (Ta = 25°C)

Item	Symbol	Value	Condition	
Emitter	Forward voltage	$V_F$ 1.5 V max.	$I_F = 30$ mA	
	Reverse current	$I_R$ 10 μA max.	$V_R = 4$ V	
	Peak emission wavelength	$\lambda_P$ 920 nm typ.	$I_F = 20$ mA	
Detector	Light current	$I_L$ 160 μA min., 2,000 μA max.	$I_F = 20$ mA, $V_{CE} = 5$ V White paper with a reflection ratio of 90%, $d = 4$ mm (see note)	
	Dark current	$I_D$ 2 nA typ., 200 nA max.	$V_{CE} = 5$ V, 0 lx	
	Leakage current	$I_{LEAK}$ 2 μA max.	$I_F = 20$ mA, $V_{CE} = 5$ V with no reflection	
	Collector–Emitter saturated voltage	$V_{CE(sat)}$	---	---
	Peak spectral sensitivity wavelength	$\lambda_P$	850 nm typ.	$V_{CE} = 5$ V
Rising time	$t_r$	30 μs typ.	$V_{CC} = 5$ V, $R_L = 1$ kΩ, $I_L = 1$ mA	
Falling time	$t_f$	30 μs typ.	$V_{CC} = 5$ V, $R_L = 1$ kΩ, $I_L = 1$ mA	

**Note:** The letter “d” indicates the distance between the top surface of the sensor and the sensing object.

Engineering Data

Forward Current vs. Collector Dissipation Temperature Rating

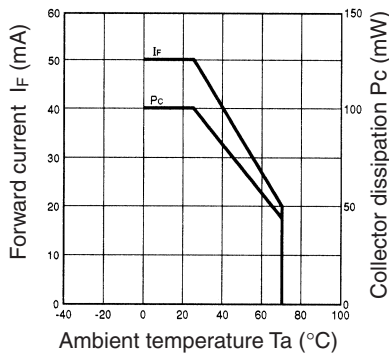

Light Current vs. Forward Current Characteristics (Typical)

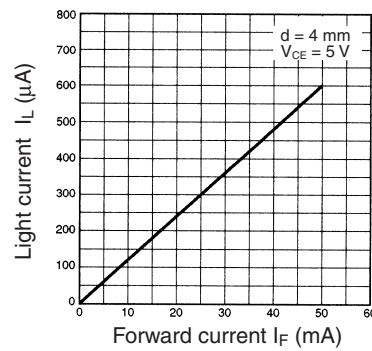

Light Current vs. Collector-Emitter Voltage Characteristics (Typical)

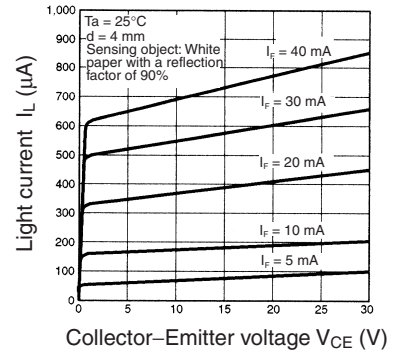

Relative Light Current vs. Ambient Temperature Characteristics (Typical)

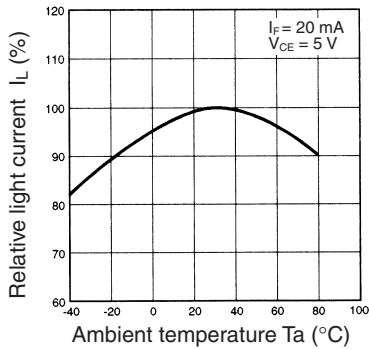

Dark Current vs. Ambient Temperature Characteristics (Typical)

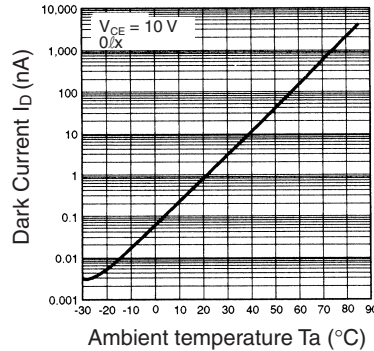

Response Time vs. Load Resistance Characteristics (Typical)

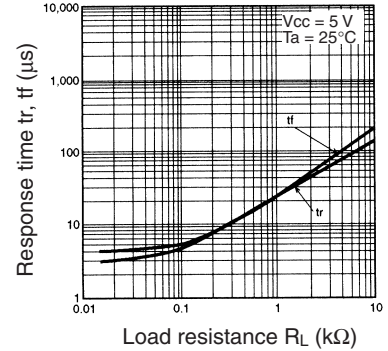

Sensing Distance Characteristics (Typical)

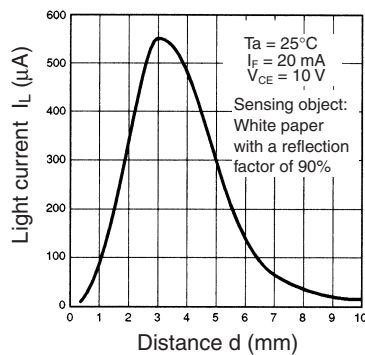

Sensing Position Characteristics (Typical)

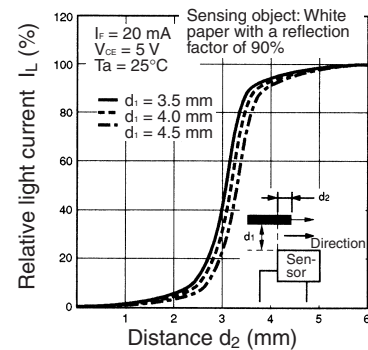

Sensing Position Characteristics (Typical)

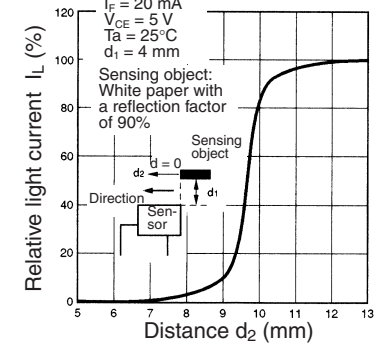

Sensing Angle Characteristics (Typical)

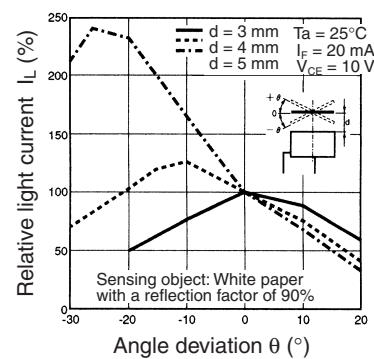

Sensing Angle Characteristics (Typical)

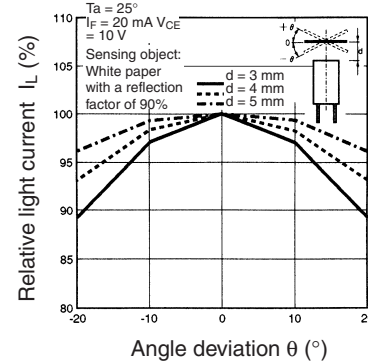

Response Time Measurement Circuit

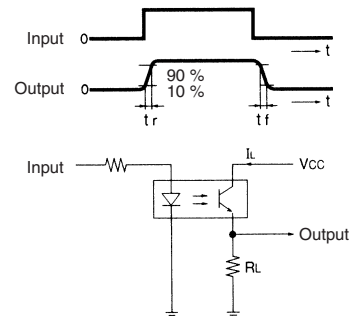

# Mouser Electronics

Authorized Distributor

Click to View Pricing, Inventory, Delivery & Lifecycle Information:

[Omron:](#)

[EE-SY169A](#)