

# D6F-A5

MEMS Flow Sensor

## High-accuracy Sensing with a Compact Body for Flow Rates Up to 50 L/min.

- Accurately detects a mass flow rate of 10 to 50 L/min.
- A compact size of 30 × 78 × 30 mm (H × W × D).



RoHS Compliant



Refer to the *Common Precautions for the D6F Series* on page 40.

## Ordering Information

### MEMS Flow Sensor

Flow Port Type	Applicable fluid	Flow rate range	Model
Manifold	Air	0 to 10 L/min	D6F-10A5-000
		0 to 20 L/min	D6F-20A5-000
		0 to 50 L/min	D6F-50A5-000

### Accessory (Sold separately)

Type	Model
Cable	D6F-CABLE1

## Connections

D6F-10A5-000

D6F-20A5-000

D6F-50A5-000

Pin No. 1: Vcc  
2: Vout  
3: GND

Connector 53398 (Made by Molex Japan)

Use the following connectors for connections to the D6F:

Housing 51021 (Made by Molex Japan)

Terminals 50079 (Made by Molex Japan)

Wires AWG28 to AWG26

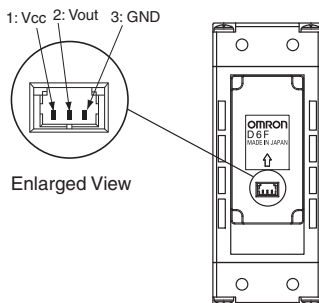

## Output Voltage Characteristics

D6F-10A5-000

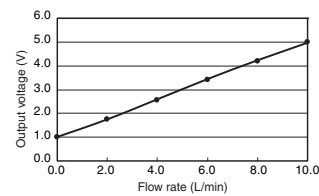

D6F-20A5-000

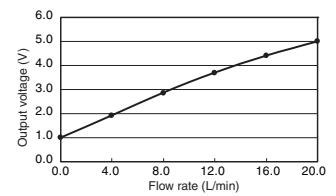

D6F-50A5-000

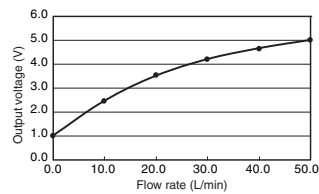

D6F-10A5-000

Flow rate L/min (normal)	0	2.0	4.0	6.0	8.0	10.0
Output voltage V	1.00	1.75	2.60	3.45	4.25	5.00
	±0.12	±0.12	±0.12	±0.12	±0.12	±0.12

D6F-20A5-000

Flow rate L/min (normal)	0	4.0	8.0	12.0	16.0	20.0
Output voltage V	1.00	1.93	2.87	3.70	4.41	5.00
	±0.12	±0.12	±0.12	±0.12	±0.12	±0.12

D6F-50A5-000

Flow rate L/min (normal)	0	10	20	30	40	50
Output voltage V	1.00	2.45	3.51	4.20	4.66	5.00
	±0.12	±0.12	±0.12	±0.12	±0.12	±0.12

Measurement conditions: Power supply voltage of 12±0.1 VDC, ambient temperature of 25±5°C, and ambient humidity of 35% to 75%.



# D6F-A6/-N6

MEMS Flow Sensor

## High-accuracy Sensing with a Compact Body for Flow Rates up to 50 L/min.

▶ Air ▶ Gas ▶ Analog

- Accurately detects a mass flow rate of 10 to 50 L/min.
- A compact size of 30 × 78 × 30 mm (H × W × D).

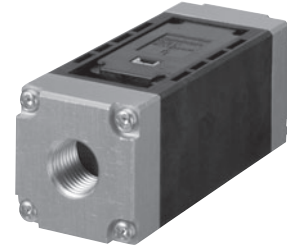

RoHS Compliant



Refer to the *Common Precautions for the D6F Series* on page 40.

## Ordering Information

### MEMS Flow Sensor

Flow Port Type	Applicable fluid	Flow rate range	Model
Rc 1/4 thread	Natural gas (13A)	0 to 5 L/min	D6F-05N6-000
		0 to 10 L/min	D6F-10A6-000
		0 to 20 L/min	D6F-20A6-000
		0 to 50 L/min	D6F-50A6-000
NPT 1/8 thread	Air	0 to 10 L/min	D6F-10A61-000
		0 to 20 L/min	D6F-20A61-000
		0 to 50 L/min	D6F-50A61-000
		NPT 1/2 thread	0 to 50 L/min

### Accessory (Sold separately)

Type	Model
Cable	D6F-CABLE1

## Connections

D6F-05N6-000  
 D6F-10A6-000      D6F-10A61-000  
 D6F-20A6-000      D6F-20A61-000  
 D6F-50A6-000      D6F-50A61-000  
 D6F-50A62-000

Pin No.      1: Vcc  
               2: Vout  
               3: GND  
 Connector    53398 (Made by Molex Japan)

Use the following connectors for connections to the D6F:  
 Housing      51021 (Made by Molex Japan)  
 Terminals    50079 (Made by Molex Japan)  
 Wires        AWG28 to AWG26

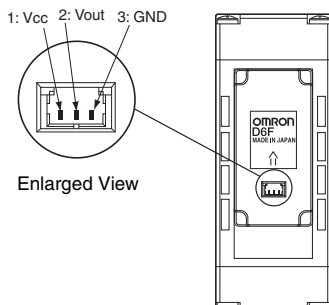

## Output Voltage Characteristics

D6F-10A6-000  
D6F-10A61-000

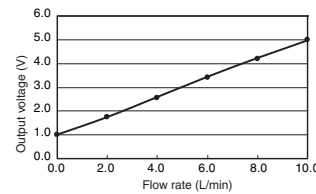

D6F-20A6-000  
D6F-20A61-000

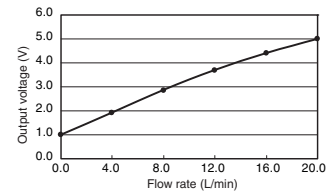

D6F-50A6-000  
D6F-50A61-000  
D6F-50A62-000

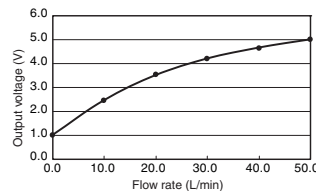

D6F-05N6-000

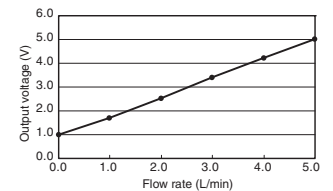

### D6F-05N6-000

Flow rate L/min (normal)	0	1.0	2.0	3.0	4.0	5.0
Output voltage V	1.00	1.71	2.53	3.40	4.22	5.00
	±0.12	±0.12	±0.12	±0.12	±0.12	±0.12

### D6F-10A6-000/D6F-10A61-000

Flow rate L/min (normal)	0	2.0	4.0	6.0	8.0	10.0
Output voltage V	1.00	1.75	2.60	3.45	4.25	5.00
	±0.12	±0.12	±0.12	±0.12	±0.12	±0.12

### D6F-20A6-000/D6F-20A61-000

Flow rate L/min (normal)	0	4	8	12	16	20
Output voltage V	1.00	1.93	2.87	3.70	4.41	5.00
	±0.12	±0.12	±0.12	±0.12	±0.12	±0.12

### D6F-50A6-000/D6F-50A61-000/D6F-50A62-000

Flow rate L/min (normal)	0	10	20	30	40	50
Output voltage V	1.00	2.45	3.51	4.20	4.66	5.00
	±0.12	±0.12	±0.12	±0.12	±0.12	±0.12

Measurement conditions: Power supply voltage of 12±0.1 VDC, ambient temperature of 25±5°C, and ambient humidity of 35% to 75%.

## Characteristics/Performance

Model	D6F-05N6-000	D6F-10A6-000	D6F-20A6-000	D6F-50A6-000	D6F-10A61-000	D6F-20A61-000	D6F-50A61-000	D6F-50A62-000
Flow Range (See note 1.)	0 to 5 L/min	0 to 10 L/min	0 to 20 L/min	0 to 50 L/min	0 to 10 L/min	0 to 20 L/min	0 to 50 L/min	0 to 50 L/min
Calibration Gas (See note 2.)	Natural gas (13A)	Air						
Flow Port Type	Rc 1/4 thread				NPT 1/8 thread			NPT 1/2 thread
Electrical Connection	Three-pin connector							
Power Supply	10.8 to 26.4 VDC							
Current Consumption	15 mA max. with no load, with a Vcc of 12 to 24 VDC, and at 25°C							
Output Voltage	1 to 5 VDC (non-linear output, load resistance of 10kΩ min.)							
Accuracy	±3% FS (25°C characteristic)							
Repeatability (See note 3.)	±0.3% FS							
Output Voltage (Max.)	5.7 VDC (Load resistance: 10 kΩ)							
Output Voltage (Min.)	0 VDC (Load resistance: 10 kΩ)							
Rated Power Supply Voltage	26.4 VDC							
Rated Output Voltage	6 VDC							
Case	PPS/aluminum alloy							
Degree of Protection	IEC IP40 (Excluding tubing sections.)							
Withstand Pressure	500 kPa							
Pressure Drop (See note 3.)	0.68 kPa	0.10 kPa	0.28 kPa	1.44 kPa	0.15 kPa	0.52 kPa	2.31 kPa	2.16 kPa
Operating Temperature (See note 4.)	-10 to 60°C							
Operating Humidity (See note 4.)	35% to 85%							
Storage Temperature (See note 4.)	-10 to 80°C	-30 to 80°C						
Storage Humidity (See note 4.)	35% to 85%							
Temperature Characteristics	±3% FS for 25°C characteristic at an ambient temperature of -10 to 60°C							
Insulation Resistance	Between Sensor outer cover and lead terminals: 20 MΩ min. (at 500 VDC)							
Dielectric Strength	Between Sensor outer cover and lead terminals: 500 VAC, 50/60 Hz min. for 1 min (leakage current: 1 mA max.)							
Weight	103 g							

Note: 1. Volumetric flow rate at 0°C, 101.3 kPa.

Note: 2. Dry gas. (must not contain large particles, e.g., dust, oil, or mist.)

Note: 3. Reference (typical)

Note: 4. With no condensation or icing.

## Dimensions (Unit: mm)

### MEMS Flow Sensors

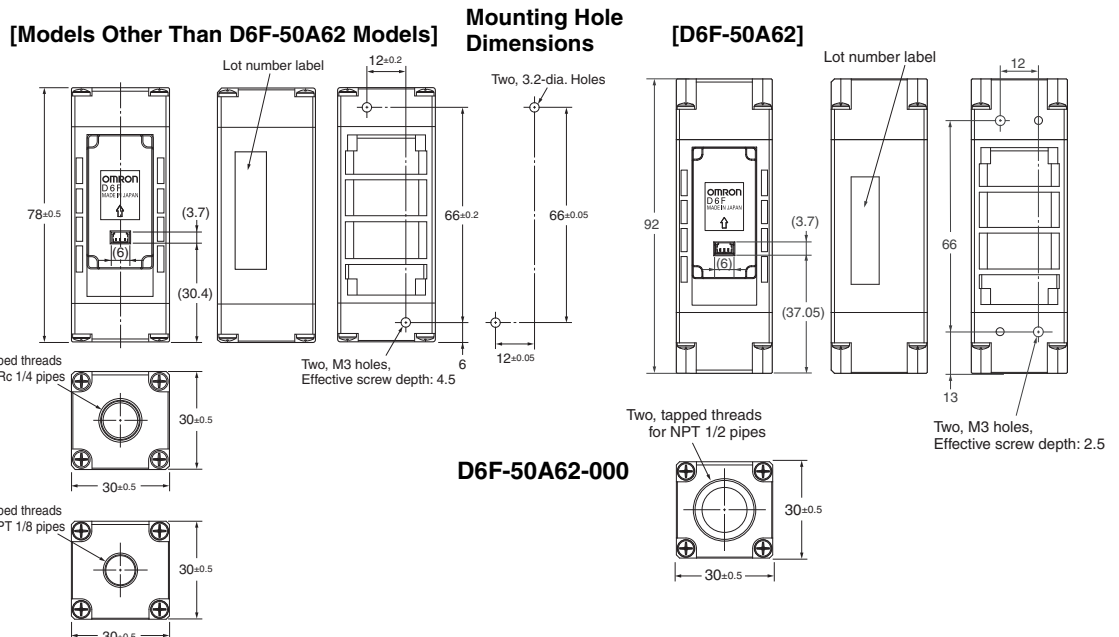

### Cable (Sold separately)

#### D6F-CABLE1

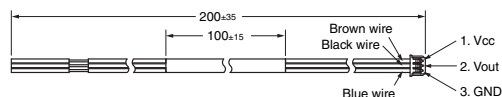

# Mouser Electronics

Authorized Distributor

Click to View Pricing, Inventory, Delivery & Lifecycle Information:

[Omron:](#)

[D6F-20A7D-000-0](#)