

## Standard Flat Sensors in Many Different Variations



- Only 6 mm thick yet provides a sensing distance of 3 mm (TL-W3MC1).
- Aluminum die-cast models also available.



Be sure to read *Safety Precautions* on page 7.

For the most recent information on models that have been certified for safety standards, refer to your OMRON website.

## Ordering Information

Sensors [Refer to *Dimensions* on page 8.]

### DC 2-Wire Models

Appearance	Sensing distance			Model	
				Operation mode	
				NO	NC
Unshielded 	5 mm			TL-W5MD1 2M *1 *2	TL-W5MD2 2M *2

### DC 3-Wire Models

Appearance	Sensing distance			Output configuration	Model	
					Operation mode	
					NO	NC
Unshielded 	1.5 mm			NPN	TL-W1R5MC1 2M *1 *2	---
				PNP	TL-W1R5MB1 2M	---
	3 mm			NPN	TL-W3MC1 2M *1 *2	TL-W3MC2 2M *1 *2
				PNP	TL-W3MB1 2M *2	TL-W3MB2 2M *2
	5 mm			NPN	TL-W5MC1 2M *1 *2	TL-W5MC2 2M
				PNP	TL-W5MB1 2M	TL-W5MB2 2M
20 mm			NPN	TL-W20ME1 2M *1	TL-W20ME2 2M *1	
Shielded 	5 mm			NPN	TL-W5E1 2M	TL-W5E2 2M
				PNP	TL-W5F1 2M	TL-W5F2 2M

\*1. Models with a different frequency are also available to prevent mutual interference. The model numbers are TL-W□M□□5 (e.g., TL-W5MD15).

\*2. Models are also available with robotics (bend resistant) cables. Add "-R" to the model number. (e.g., TL-W5MC1-R 2M)

### Mounting Bracket (Attachment)

Order a Nut Set when required, e.g., if you lose the nuts.

Model	Applicable Sensors	Quantity
Y92E-D2R5	TL-W1R5□	1
Y92E-D3	TL-W3□	

## Ratings and Specifications

### DC 2-Wire Models

Item	Model	TL-W5MD□
Sensing distance		5 mm ±10%
Set distance		0 to 4 mm
Differential travel		10% max. of sensing distance
Detectable object		Ferrous metal (The sensing distance decreases with non-ferrous metal. Refer to <i>Engineering Data</i> on page 5.)
Standard sensing object		Iron, 18 × 18 × 1 mm
Response frequency *1		500 Hz
Power supply voltage (operating voltage range)		12 to 24 VDC (10 to 30 VDC), ripple (p-p): 10% max.
Leakage current		0.8 mA max.
Control output	Load current	3 to 100 mA
	Residual voltage	3.3 V max. (under load current of 100 mA with cable length of 2 m)
Indicators		D1 Models: Operation indicator (red), Setting indicator (green) D2 Models: Operation indicator (red)
Operation mode (with sensing object approaching)		D1 Models: NO Refer to the timing charts under <i>I/O Circuit Diagrams</i> on page 5 for details. D2 Models: NC
Protection circuits		Load short-circuit protection, Surge suppressor
Ambient temperature range		Operating/Storage: -25 to 70°C (with no icing or condensation) *2
Ambient humidity range		Operating/Storage: 35% to 95% (with no condensation)
Temperature influence		±10% max. of sensing distance at 23°C in the temperature range of -25 to 70°C
Voltage influence		±2.5% max. of sensing distance at rated voltage in the rated voltage ±15% range
Insulation resistance		50 MΩ min. (at 500 VDC) between current-carrying parts and case
Dielectric strength		1,000 VAC for 1 min between current-carrying parts and case
Vibration resistance		Destruction: 10 to 55 Hz, 1.5-mm double amplitude for 2 hours each in X, Y, and Z directions
Shock resistance		Destruction: 500 m/s <sup>2</sup> 3 times each in X, Y, and Z directions
Degree of protection		IEC 60529 IP67, in-house standards: oil-resistant *2
Connection method		Pre-wired Models (Standard cable length: 2 m)
Weight (packed state)		Approx. 80 g
Materials	Case	Heat-resistant ABS
	Sensing surface	
Accessories		Instruction manual

\*1. The response frequency is an average value.

Measurement conditions are as follows: standard sensing object, a distance of twice the standard sensing object, and a set distance of half the sensing distance.

\*2. For environments that require oil resistance, the upper limit of the ambient operating temperature range is 40°C.

DC 3-Wire Models

Item	Model	TL-W1R5MC1 TL-W1R5MB1	TL-W3MC□ TL-W3MB□	TL-W5MC□ TL-W5MB□	TL-W5E1, TL-W5E2 TL-W5F1, TL-W5F2	TL-W20ME1 TL-W20ME2
Sensing distance		1.5 mm ±10%	3 mm ±10%	5 mm ±10%		20 mm ±10%
Set distance		0 to 1.2 mm	0 to 2.4 mm	0 to 4 mm		0 to 16 mm
Differential travel		10% max. of sensing distance				1% to 15% of sensing distance
Detectable object		Ferrous metal (The sensing distance decreases with non-ferrous metal. Refer to <i>Engineering Data</i> on page 5.)				
Standard sensing object		Iron, 8 × 8 × 1 mm	Iron, 12 × 12 × 1 mm	Iron, 18 × 18 × 1 mm		Iron, 50 × 50 × 1 mm
Response frequency		1 kHz min.	600 Hz min.	500 Hz min.	300 Hz min.	40 Hz min.
Power supply voltage (operating voltage range)		12 to 24 VDC (10 to 30 VDC), ripple (p-p): 10% max.			12 to 24 VDC (10 to 30 VDC), ripple (p-p): 20% max.	12 to 24 VDC (10 to 30 VDC), ripple (p-p): 10% max.
Current consumption		15 mA max. at 24 VDC (no-load)		10 mA max. at 24 VDC (no-load)	15 mA max. at 24 VDC (no-load)	8 mA at 12 VDC, 15 mA at 24 VDC
Control output	Load current	TL-W1R5MC1/-W3MC□: NPN open collector 100 mA max. at 30 VDC max. TL-W1R5MB1/-W3MB□: PNP open collector 100 mA max. at 30 VDC max.		TL-W5MC□: NPN open collector 50 mA max. at 12 VDC (30 VDC max.) 100 mA max. at 24 VDC (30 VDC max.) TL-W5MB□: PNP open collector 50 mA max. at 12 VDC (30 VDC max.) 100 mA max. at 24 VDC (30 VDC max.)	200 mA	100 mA max. at 12 VDC 200 mA max. at 24 VDC
	Residual voltage	1 V max. (under load current of 100 mA with cable length of 2 m)		2 V max. (under load current of 200 mA with cable length of 2 m)	1 V max. (under load current of 200 mA with cable length of 2 m)	
Indicators		Detection indicator (red)				
Operation mode (with sensing object approaching)		NO	B1/C1 Models: NO B2/C2 Models: NC		E1/F1 Models: NO E2/F2 Models: NC	
		Refer to the timing charts under <i>I/O Circuit Diagrams</i> on page 6 for details.				
Protection circuits		Reverse polarity protection, Surge suppressor				
Ambient temperature range		Operating/Storage: -25 to 70°C (with no icing or condensation) *				
Ambient humidity range		Operating/Storage: 35% to 95% (with no condensation)				
Temperature influence		±10% max. of sensing distance at 23°C in the temperature range of -25 to 70°C				
Voltage influence		±2.5% max. of sensing distance at rated voltage in the rated voltage ±10% range		±2.5% max. of sensing distance at rated voltage in the rated voltage ±20% range	±2.5% max. of sensing distance at rated voltage in the rated voltage ±10% range	
Insulation resistance		50 MΩ min. (at 500 VDC) between current-carrying parts and case				
Dielectric strength		1,000 VAC, 50/60 Hz for 1 minute between current-carrying parts and case				
Vibration resistance		Destruction: 10 to 55 Hz, 1.5-mm double amplitude for 2 hours each in X, Y, and Z directions				
Shock resistance		Destruction: 500 m/s <sup>2</sup> 3 times each in X, Y, and Z directions				Destruction: 500 m/s <sup>2</sup> 10 times each in X, Y, and Z directions
Degree of protection		IEC 60529 IP67, in-house standards: oil-resistant *				
Connection method		Pre-wired Models (Standard cable length: 2 m)				
Weight (packed state)		Approx. 70 g		Approx. 80 g	Approx. 100 g	Approx. 210 g
Materials	Case	Heat-resistant ABS			Aluminum die-cast	Heat-resistant ABS
	Sensing surface	Heat-resistant ABS				
Accessories		Mounting Bracket, Instruction manual		Instruction manual		

\* For environments that require oil resistance, the upper limit of the ambient operating temperature range is 40°C.

## Engineering Data (Reference Value)

### Sensing Area

TL-W1R5M□1

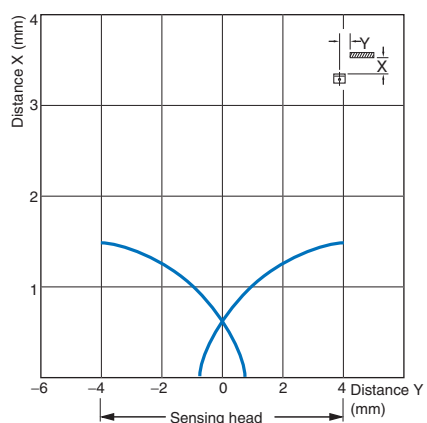

TL-W3M□1

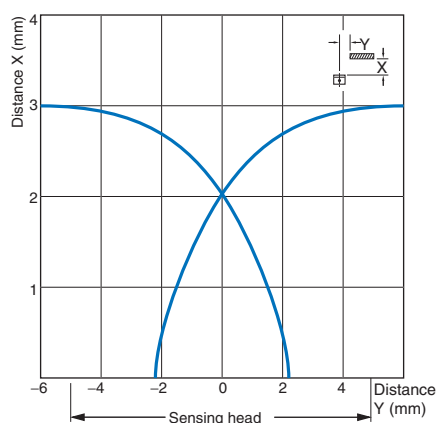

TL-W5M□1/W5MD□

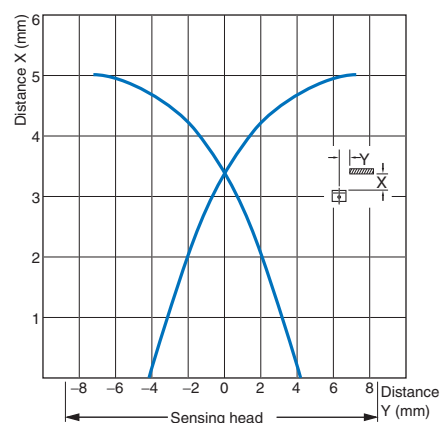

TL-W5E/-W5F

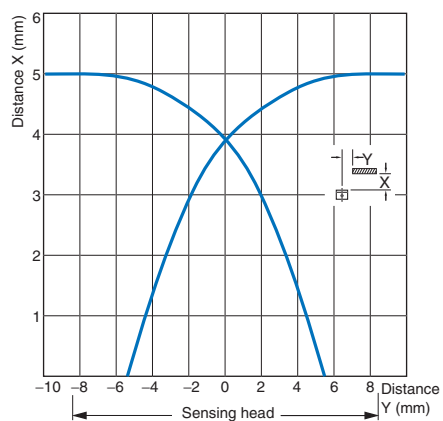

TL-W20□

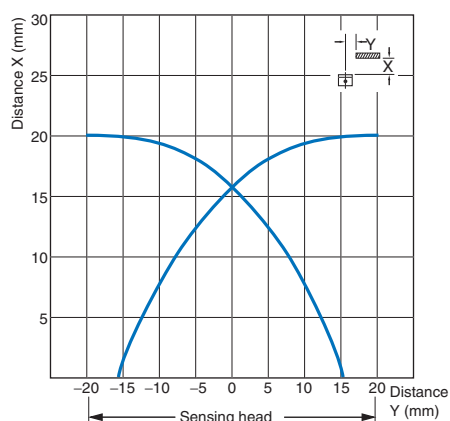

**Influence of Sensing Object Size and Material**

**TL-W1R5M□1**

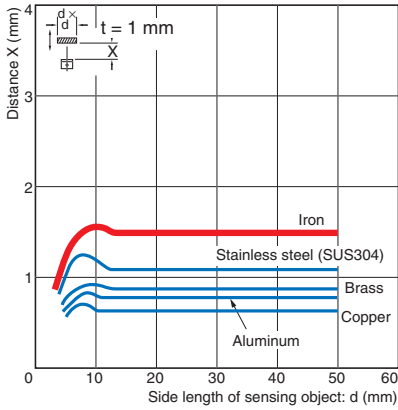

**TL-W3M□1**

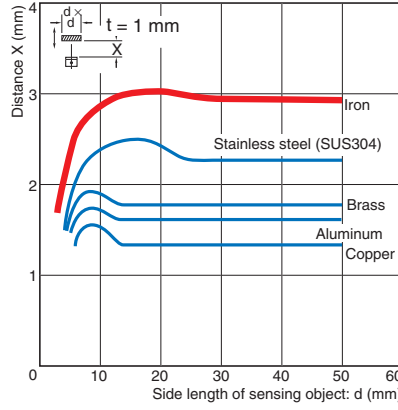

**TL-W5M□1**

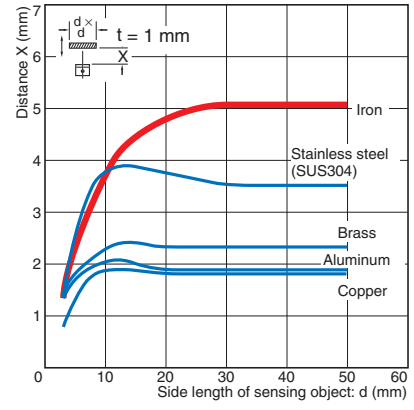

**TL-W5E□/-W5F□/-W5MD□**

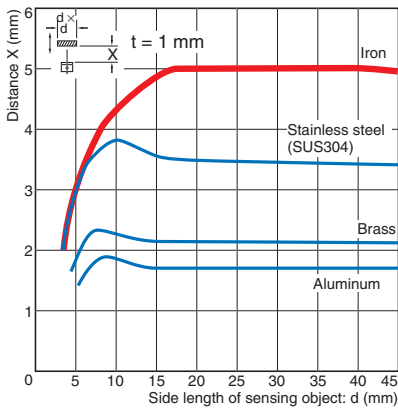

**TL-W20□**

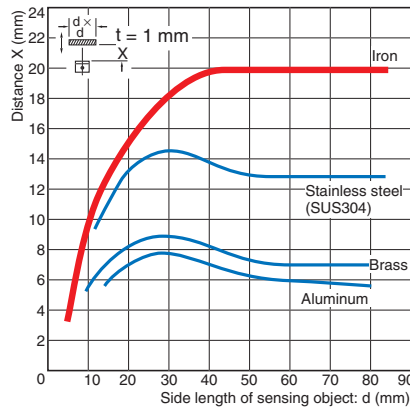

**I/O Circuit Diagrams**

**DC 2-Wire Models**

Model	Operation mode	Timing chart	Output circuit
TL-W5MD1	NO		<p>Note: The load can be connected to either the +V or 0 V side.</p>
TL-W5MD2	NC		

DC 3-Wire Models

Model	Operation mode	Output configuration	Timing chart	Output circuit
TL-W1R5MC1 TL-W3MC1 TL-W5MC1	NO	NPN	<p>Sensing object</p> <p>Present Not present</p> <p>Output transistor (load)</p> <p>ON OFF</p> <p>Detection indicator (red)</p> <p>ON OFF</p>	<p>* Load current: 100 mA max.</p>
TL-W3MC2 TL-W5MC2	NC	NPN	<p>Sensing object</p> <p>Present Not present</p> <p>Output transistor (load)</p> <p>ON OFF</p> <p>Detection indicator (red)</p> <p>ON OFF</p>	<p>* Load current: 100 mA max.</p>
TL-W1R5MB1	NO	PNP	<p>Sensing object</p> <p>Present Not present</p> <p>Output transistor (load) (between blue and black leads)</p> <p>ON OFF</p> <p>Detection indicator (red)</p> <p>ON OFF</p>	<p>* Load current: 100 mA max.</p>
TL-W3MB1 TL-W5MB1	NO	PNP	<p>Sensing object</p> <p>Present Not present</p> <p>Output transistor (load) (between blue and black leads)</p> <p>ON OFF</p> <p>Detection indicator (red)</p> <p>ON OFF</p>	<p>* Load current: 100 mA max.</p>
TL-W3MB2 TL-W5MB2	NC	PNP	<p>Sensing object</p> <p>Present Not present</p> <p>Output transistor (load) (between blue and black leads)</p> <p>ON OFF</p> <p>Detection indicator (red)</p> <p>ON OFF</p>	<p>* Load current: 100 mA max.</p>
TL-W5E1 TL-W20ME1	NO	NPN	<p>Sensing object</p> <p>Present Not present</p> <p>Load (between brown and black leads)</p> <p>Operate Reset</p> <p>Output voltage (between black and blue leads)</p> <p>High Low</p> <p>Detection indicator (red)</p> <p>ON OFF</p>	<p>*1. Load current: 200 mA max. *2. When a transistor is connected.</p>
TL-W5E2 TL-W20ME2	NC	NPN	<p>Sensing object</p> <p>Present Not present</p> <p>Load (between brown and black leads)</p> <p>Operate Reset</p> <p>Output voltage (between black and blue leads)</p> <p>High Low</p> <p>Detection indicator (red)</p> <p>ON OFF</p>	<p>*1. Load current: 200 mA max. *2. When a transistor is connected.</p>
TL-W5F1	NO	PNP	<p>Sensing object</p> <p>Present Not present</p> <p>Load (between blue and black leads)</p> <p>Operate Reset</p> <p>Output voltage (between blue and black leads)</p> <p>High Low</p> <p>Detection indicator (red)</p> <p>ON OFF</p>	<p>*1. Load current: 200 mA max. *2. When a transistor is connected.</p>
TL-W5F2	NC	PNP	<p>Sensing object</p> <p>Present Not present</p> <p>Load (between blue and black leads)</p> <p>Operate Reset</p> <p>Output voltage (between blue and black leads)</p> <p>High Low</p> <p>Detection indicator (red)</p> <p>ON OFF</p>	<p>*1. Load current: 200 mA max. *2. When a transistor is connected.</p>

## Safety Precautions

Refer to *Warranty and Limitations of Liability*.

### ⚠ WARNING

This product is not designed or rated for ensuring safety of persons either directly or indirectly. Do not use it for such purposes.



### Precautions for Correct Use

Do not use this product under ambient conditions that exceed the ratings.

#### ● Design

##### Influence of Surrounding Metal

When mounting the Sensor within a metal panel, ensure that the clearances given in the following table are maintained. Failure to maintain these distances may cause deterioration in the performance of the Sensor.

Metal on a Single Side  
(Not Exceeding the Height of the Sensor Surface)

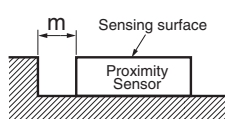

Metals on Both Sides and in Front of the Sensor

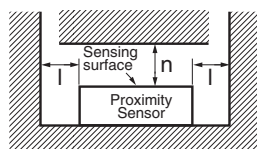

##### Influence of Surrounding Metal (Unit: mm)

Model	Distance	l	m	n
TL-W1R5M□1		2	0	8
TL-W3MC□/-W3MB□		3		12
TL-W5MD□		5		20
TL-W5MC□/-W5MB□				
TL-W20ME□		25	16	100
TL-W5E□/-W5F□		0	0	20

##### Mutual Interference

When installing Sensors face-to-face or side-by-side, ensure that the minimum distances given in the following table are maintained.

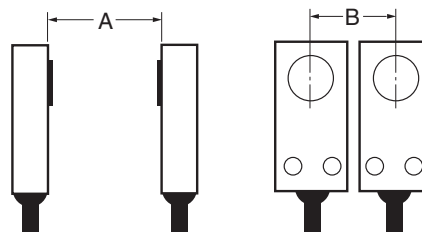

##### Mutual Interference (Unit: mm)

Model	Distance	A	B
TL-W1R5MC1		75 (50)	25 (8) *
TL-W1R5MB1		75	25
TL-W3MC□/-W3MB□		90 (60)	30 (10) *
TL-W5MD□		120 (80)	60 (30)
TL-W5MC□/-W5MB□			
TL-W20ME□		200 (100)	200 (100)
TL-W5E□/-W5F□		50	35

Note: Values in parentheses apply to Sensors operating at different frequencies.

\* Mutual interference will not occur for close-proximity mounting if models with different frequencies are used together.

#### ● Mounting

- Use M3 flat-head screws to mount the TL-W1R5M□1 and TL-W3M□.
- Do not exceed the torque in the following table when tightening the resin cover screws.

Model	Torque
TL-W1R5M□1	0.98 N·m
TL-W3MC□/-W3MB□	
TL-W5MD□	
TL-W20M□	1.5 N·m

#### ● Adjustment

##### Turning ON the Power

An error pulse will occur (approximately 1 ms) if adjustments are made when turning ON the power or making AND connections.

#### Applicable e-CON Connector Models and Manufacturers

The companies and model number of e-CON connections that can be used with Sensor cables are listed in the following table. Confirm applicability when purchasing e-CON connectors for connection to Pre-wired Sensors.

Model	Applicable e-CON Connector	Manufacturer
TL-W1R5□/-W3□	XN2A-1470 Cable Plug Connector	OMRON

Dimensions

(Unit: mm)  
Tolerance class IT16 applies to dimensions in this data sheet unless otherwise specified.

TL-W1R5MB1  
TL-W1R5MC1

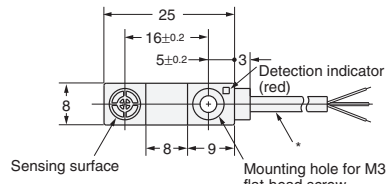
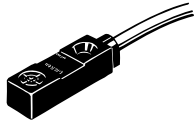

Mounting Bracket (Attachment)

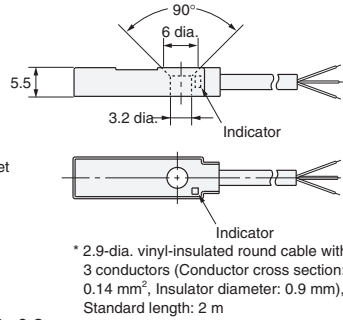
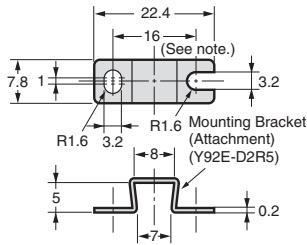

Note: Mounting hole dimension: 17 ±0.2.  
Material: Stainless steel (SUS304)

TL-W3MB□  
TL-W3MC□

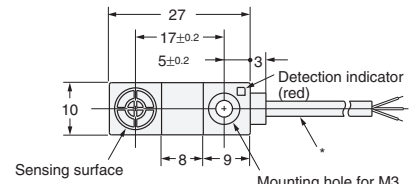
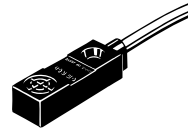

Mounting Bracket (Attachment)

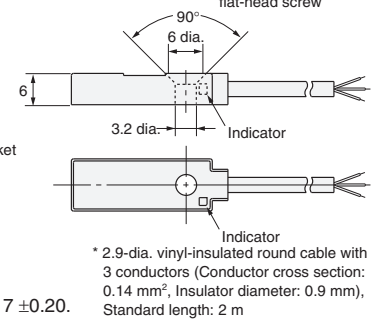
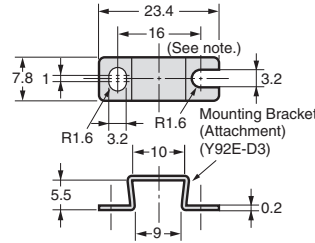

Note: Mounting hole dimension: 17 ±0.2.  
Material: Stainless steel (SUS304)

TL-W5MB□  
TL-W5MC□  
TL-W5MD□

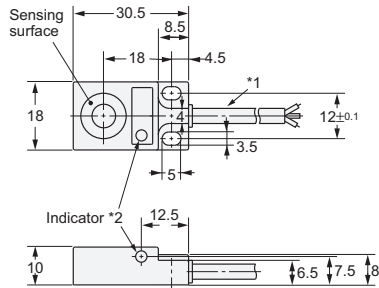

\*1. TL-W5MB□/TL-W5MC□  
4-dia. vinyl-insulated round cable with 3 conductors (Conductor cross section: 0.2 mm<sup>2</sup>, Insulator diameter: 1.2 mm), Standard length: 2 m  
TL-W5MD□  
4-dia. vinyl-insulated round cable with 2 conductors (Conductor cross section: 0.3 mm<sup>2</sup>, Insulation diameter: 1.3 mm), Standard length: 2 m  
\*2. B/C Models: Detection indicator (red)  
D Models: Operation indicator (red), Setting indicator (green)

TL-W5E□  
TL-W5F□

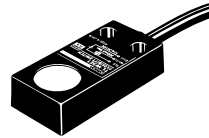

Mounting Hole Dimensions

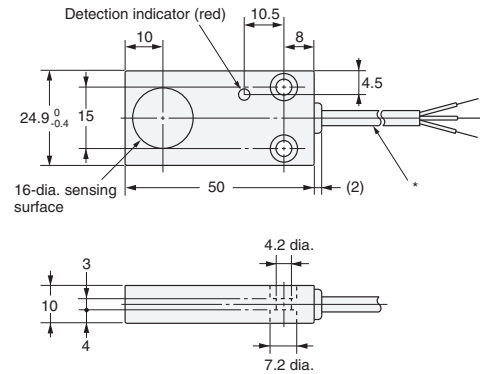
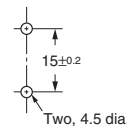

\* 4-dia. vinyl-insulated round cable with 3 conductors (Conductor cross section: 0.2 mm<sup>2</sup>, Insulator diameter: 1.2 mm), Standard length: 2 m

TL-W20ME□

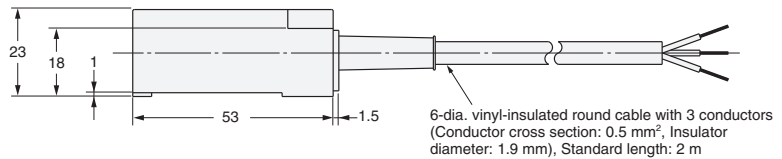
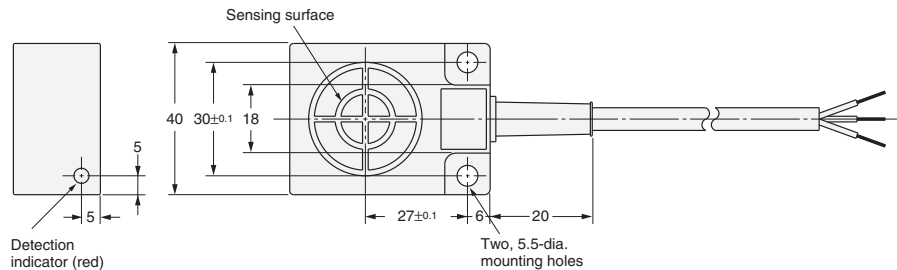
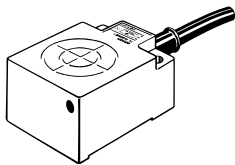



## Terms and Conditions Agreement

### Read and understand this catalog.

Please read and understand this catalog before purchasing the products. Please consult your OMRON representative if you have any questions or comments.

### Warranties.

(a) Exclusive Warranty. Omron's exclusive warranty is that the Products will be free from defects in materials and workmanship for a period of twelve months from the date of sale by Omron (or such other period expressed in writing by Omron). Omron disclaims all other warranties, express or implied.

(b) Limitations. OMRON MAKES NO WARRANTY OR REPRESENTATION, EXPRESS OR IMPLIED, ABOUT NON-INFRINGEMENT, MERCHANTABILITY OR FITNESS FOR A PARTICULAR PURPOSE OF THE PRODUCTS. BUYER ACKNOWLEDGES THAT IT ALONE HAS DETERMINED THAT THE PRODUCTS WILL SUITABLY MEET THE REQUIREMENTS OF THEIR INTENDED USE.

Omron further disclaims all warranties and responsibility of any type for claims or expenses based on infringement by the Products or otherwise of any intellectual property right. (c) Buyer Remedy. Omron's sole obligation hereunder shall be, at Omron's election, to (i) replace (in the form originally shipped with Buyer responsible for labor charges for removal or replacement thereof) the non-complying Product, (ii) repair the non-complying Product, or (iii) repay or credit Buyer an amount equal to the purchase price of the non-complying Product; provided that in no event shall Omron be responsible for warranty, repair, indemnity or any other claims or expenses regarding the Products unless Omron's analysis confirms that the Products were properly handled, stored, installed and maintained and not subject to contamination, abuse, misuse or inappropriate modification. Return of any Products by Buyer must be approved in writing by Omron before shipment. Omron Companies shall not be liable for the suitability or unsuitability or the results from the use of Products in combination with any electrical or electronic components, circuits, system assemblies or any other materials or substances or environments. Any advice, recommendations or information given orally or in writing, are not to be construed as an amendment or addition to the above warranty.

See <http://www.omron.com/global/> or contact your Omron representative for published information.

### Limitation on Liability: Etc.

OMRON COMPANIES SHALL NOT BE LIABLE FOR SPECIAL, INDIRECT, INCIDENTAL, OR CONSEQUENTIAL DAMAGES, LOSS OF PROFITS OR PRODUCTION OR COMMERCIAL LOSS IN ANY WAY CONNECTED WITH THE PRODUCTS, WHETHER SUCH CLAIM IS BASED IN CONTRACT, WARRANTY, NEGLIGENCE OR STRICT LIABILITY.

Further, in no event shall liability of Omron Companies exceed the individual price of the Product on which liability is asserted.

### Suitability of Use.

Omron Companies shall not be responsible for conformity with any standards, codes or regulations which apply to the combination of the Product in the Buyer's application or use of the Product. At Buyer's request, Omron will provide applicable third party certification documents identifying ratings and limitations of use which apply to the Product. This information by itself is not sufficient for a complete determination of the suitability of the Product in combination with the end product, machine, system, or other application or use. Buyer shall be solely responsible for determining appropriateness of the particular Product with respect to Buyer's application, product or system. Buyer shall take application responsibility in all cases.

NEVER USE THE PRODUCT FOR AN APPLICATION INVOLVING SERIOUS RISK TO LIFE OR PROPERTY OR IN LARGE QUANTITIES WITHOUT ENSURING THAT THE SYSTEM AS A WHOLE HAS BEEN DESIGNED TO ADDRESS THE RISKS, AND THAT THE OMRON PRODUCT(S) IS PROPERLY RATED AND INSTALLED FOR THE INTENDED USE WITHIN THE OVERALL EQUIPMENT OR SYSTEM.

### Programmable Products.

Omron Companies shall not be responsible for the user's programming of a programmable Product, or any consequence thereof.

### Performance Data.

Data presented in Omron Company websites, catalogs and other materials is provided as a guide for the user in determining suitability and does not constitute a warranty. It may represent the result of Omron's test conditions, and the user must correlate it to actual application requirements. Actual performance is subject to the Omron's Warranty and Limitations of Liability.

### Change in Specifications.

Product specifications and accessories may be changed at any time based on improvements and other reasons. It is our practice to change part numbers when published ratings or features are changed, or when significant construction changes are made. However, some specifications of the Product may be changed without any notice. When in doubt, special part numbers may be assigned to fix or establish key specifications for your application. Please consult with your Omron's representative at any time to confirm actual specifications of purchased Product.

### Errors and Omissions.

Information presented by Omron Companies has been checked and is believed to be accurate; however, no responsibility is assumed for clerical, typographical or proofreading errors or omissions.

# Mouser Electronics

Authorized Distributor

Click to View Pricing, Inventory, Delivery & Lifecycle Information:

Omron:

[TL-W5MB2](#) [TL-W3MB1](#) [TL-W3MB2-5 5M](#) [TL-W1R5MB1 6M](#) [TL-W1R5MB1-5M](#) [TL-W3MB1-R 2M](#)