

# MOS FET Relays G3VM-61H1

**MOS FET Relay Designed for Switching Minute and Analog Signals has a 6-pin SOP Package and 60-V Load Voltage**

- Continuous load current of 400 mA.
- Dielectric strength of 1,500 Vrms between I/O.
- RoHS Compliant.

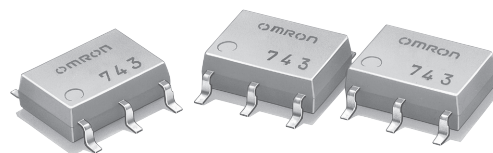

**Note:** The actual product is marked differently from the image shown here.

■ **Application Examples**

- Broadband systems
- Measurement devices
- Data loggers
- Amusement machines

■ **List of Models**

Contact form	Terminals	Load voltage (peak value)	Model	Number per stick	Number per tape
SPST-NO	Surface-mounting terminals	60 VAC	G3VM-61H1	75	---
			G3VM-61H1(TR)	---	2,500

■ **Dimensions**

**Note:** All units are in millimeters unless otherwise indicated.

G3VM-61H1

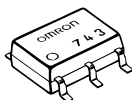

**Note:** The actual product is marked differently from the image shown here.

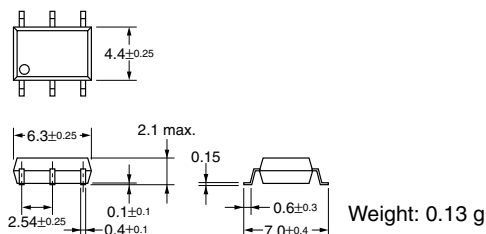

■ **Terminal Arrangement/Internal Connections (Top View)**

G3VM-61H1

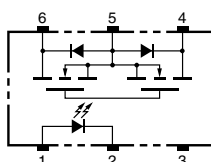

■ **Actual Mounting Pad Dimensions (Recommended Value, Top View)**

G3VM-61H1

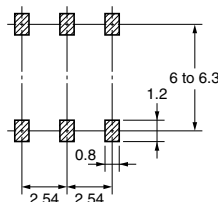

■ Absolute Maximum Ratings (Ta = 25°C)

Item		Symbol	Rating	Unit	Measurement conditions	
Input	LED forward current	$I_F$	50	mA		
	Repetitive peak LED forward current	$I_{FP}$	1	A	100 $\mu$ s pulses, 100 pps	
	LED forward current reduction rate	$\Delta I_F/^\circ\text{C}$	-0.5	mA/ $^\circ\text{C}$	$T_a \geq 25^\circ\text{C}$	
	LED reverse voltage	$V_R$	5	V		
	Connection temperature	$T_j$	125	$^\circ\text{C}$		
Output	Load voltage (AC peak/DC)	$V_{OFF}$	60	V		
	Continuous load current	Connection A	400	mA		
		Connection B	400			
		Connection C	800			
	ON current reduction rate	Connection A	$\Delta I_{ON}/^\circ\text{C}$	-4.0	mA/ $^\circ\text{C}$	$T_a \geq 25^\circ\text{C}$
		Connection B		-4.0		
		Connection C		-8.0		
Connection temperature	$T_j$	125	$^\circ\text{C}$			
Dielectric strength between input and output (See note 1.)		$V_{I-O}$	1,500	$V_{rms}$	AC for 1 min	
Operating temperature		$T_a$	-40 to +85	$^\circ\text{C}$	With no icing or condensation	
Storage temperature		$T_{stg}$	-55 to +125	$^\circ\text{C}$	With no icing or condensation	
Soldering temperature (10 s)		---	260	$^\circ\text{C}$	10 s	

Note: 1. The dielectric strength between the input and output was checked by applying voltage between all pins as a group on the LED side and all pins as a group on the light-receiving side.

Connection Diagram

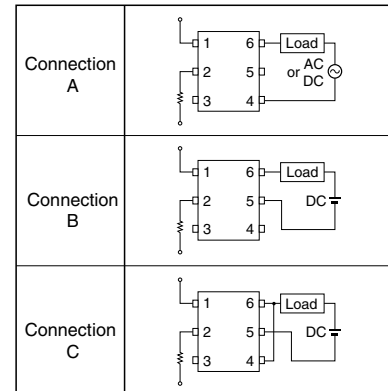

■ Electrical Characteristics (Ta = 25°C)

Item		Symbol	Minimum	Typical	Maximum	Unit	Measurement conditions	
Input	LED forward voltage	$V_F$	1.0	1.15	1.3	V	$I_F = 10 \text{ mA}$	
	Reverse current	$I_R$	---	---	10	$\mu\text{A}$	$V_R = 5 \text{ V}$	
	Capacity between terminals	$C_T$	---	30	---	pF	$V = 0, f = 1 \text{ MHz}$	
	Trigger LED forward current	$I_{FT}$	---	1.6	3	mA	$I_O = 400 \text{ mA}$	
Output	Maximum resistance with output ON	Connection A	$R_{ON}$	---	1	2	$\Omega$	$I_F = 5 \text{ mA}, I_O = 400 \text{ mA}$
		Connection B		---	0.5	1	$\Omega$	$I_F = 5 \text{ mA}, I_O = 400 \text{ mA}$
		Connection C		---	0.25	---	$\Omega$	$I_F = 5 \text{ mA}, I_O = 800 \text{ mA}$
Current leakage when the relay is open		$I_{LEAK}$	---	0.001	1.0	$\mu\text{A}$	$V_{OFF} = 60 \text{ V}$	
Capacity between terminals A Connection		$C_{OFF}$	---	130	---	pF	$V = 0, f = 1 \text{ MHz}$	
Capacity between I/O terminals		$C_{I-O}$	---	0.8	---	pF	$f = 1 \text{ MHz}, V_s = 0 \text{ V}$	
Insulation resistance		$R_{I-O}$	1,000	---	---	M $\Omega$	$V_{I-O} = 500 \text{ VDC}, R_{OH} \leq 60\%$	
Turn-ON time		$t_{ON}$	---	0.8	2.0	ms	$I_F = 5 \text{ mA}, R_L = 200 \Omega, V_{DD} = 20 \text{ V}$ (See note 2.)	
Turn-OFF time		$t_{OFF}$	---	0.1	0.5	ms		

Note: 2. Turn-ON and Turn-OFF Times

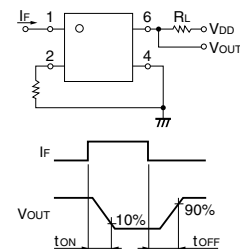

■ Recommended Operating Conditions

Use the G3VM under the following conditions so that the Relay will operate properly.

Item	Symbol	Minimum	Typical	Maximum	Unit
Load voltage (AC peak/DC)	$V_{DD}$	---	---	48	V
Operating LED forward current	$I_F$	5	7.5	25	mA
Continuous load current (AC peak/DC)	$I_O$	---	---	400	mA
Operating temperature	$T_a$	-20	---	65	$^\circ\text{C}$

■ Engineering Data

LED forward current vs. Ambient temperature

$I_F - T_a$

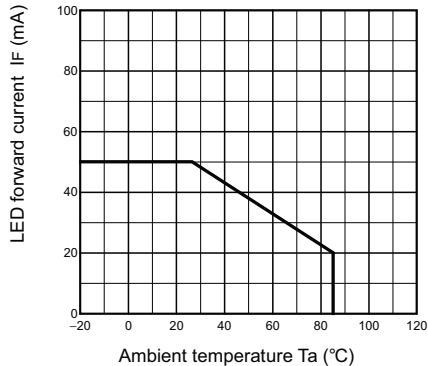

Continuous load current vs. Ambient temperature

$I_O - T_a$

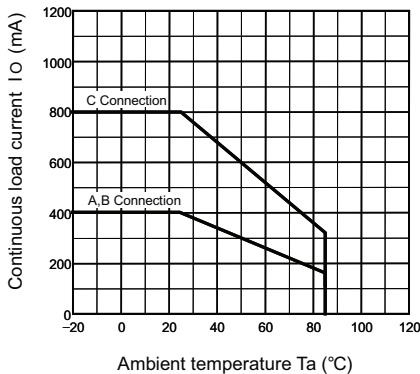

LED forward current vs. LED forward voltage

$I_F - V_F$

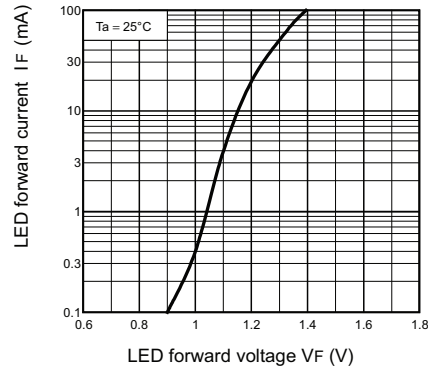

Continuous load current vs. On-state voltage

$I_O - V_{ON}$

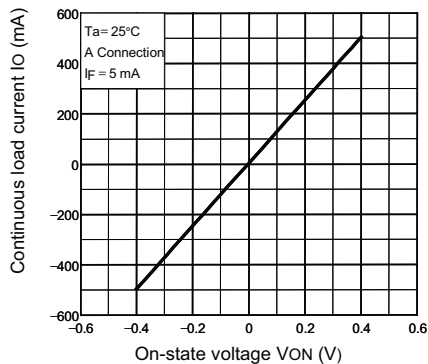

On-state resistance vs. Ambient temperature

$R_{ON} - T_a$

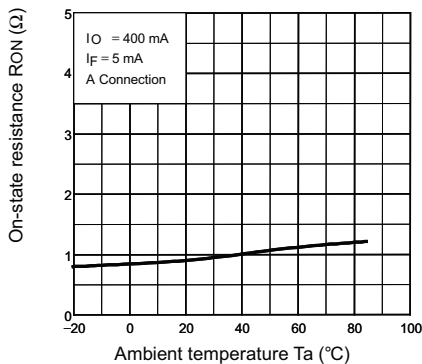

Trigger LED forward current vs. Ambient temperature

$I_{FT} - T_a$

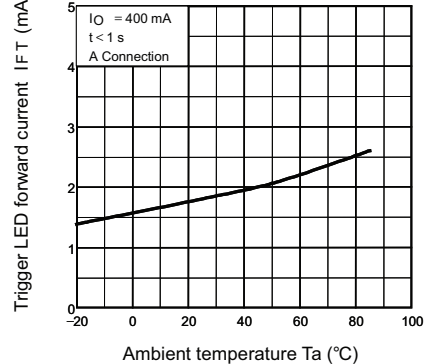

Turn ON, Turn OFF time vs. LED forward current

$t_{ON}, t_{OFF} - I_F$

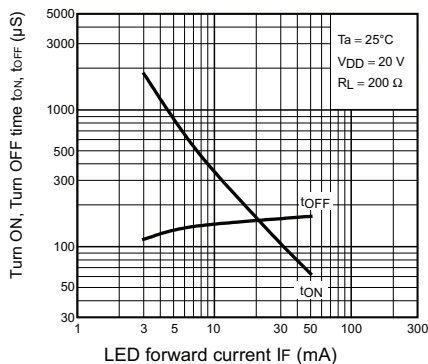

Turn ON, Turn OFF time vs. Ambient temperature

$t_{ON}, t_{OFF} - T_a$

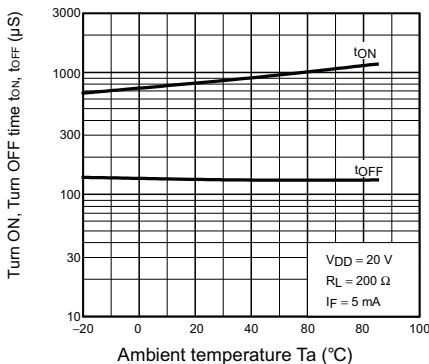

Current leakage vs. Ambient temperature

$I_{LEAK} - T_a$

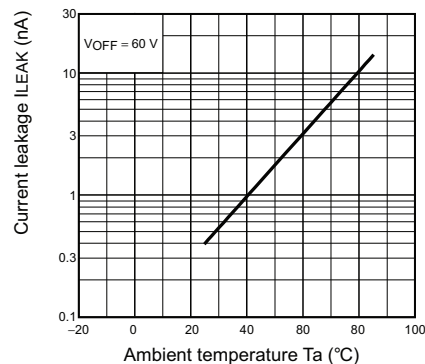

All sales are subject to Omron Electronic Components LLC standard terms and conditions of sale, which can be found at [http://www.components.omron.com/components/web/webfiles.nsf/sales\\_terms.html](http://www.components.omron.com/components/web/webfiles.nsf/sales_terms.html)

**ALL DIMENSIONS SHOWN ARE IN MILLIMETERS.**  
To convert millimeters into inches, multiply by 0.03937. To convert grams into ounces, multiply by 0.03527.

---

**OMRON**<sup>®</sup>

**OMRON ELECTRONIC  
COMPONENTS LLC**

55 E. Commerce Drive, Suite B  
Schaumburg, IL 60173

**847-882-2288**

**OMRON ON-LINE**

Global - <http://www.omron.com>

USA - <http://www.components.omron.com>

Cat. No. X302-E-1

12/10

Specifications subject to change without notice

Printed in USA

# Mouser Electronics

Authorized Distributor

Click to View Pricing, Inventory, Delivery & Lifecycle Information:

Omron:

[G3VM-61H1](#) [G3VM-61H1\(TR\)](#)