

Photomicrosensor (Transmissive) EE-SH3 Series

■ Dimensions

Note: All units are in millimeters unless otherwise indicated.

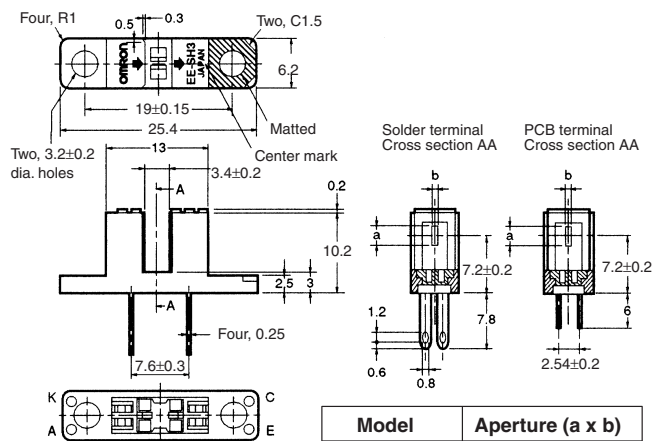

Internal Circuit

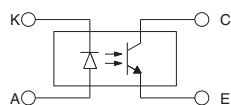

Unless otherwise specified, the tolerances are as shown below.

Dimensions	Tolerance
3 mm max.	±0.2
3 < mm ≤ 6	±0.24
6 < mm ≤ 10	±0.29
10 < mm ≤ 18	±0.35
18 < mm ≤ 30	±0.42

Terminal No.	Name
A	Anode
K	Cathode
C	Collector
E	Emitter

■ Features

- High-resolution model with a 0.2-mm-wide or 0.5-mm-wide sensing aperture, high-sensitivity model with a 1-mm-wide sensing aperture, and model with a horizontal sensing aperture are available.
- Solder terminal models: EE-SH3/-SH3-CS/-SH3-DS/-SH3-GS
- PCB terminal models: EE-SH3-B/-SH3-C/-SH3-D/-SH3-G
- RoHS Compliant.

■ Absolute Maximum Ratings (Ta = 25°C)

Item	Symbol	Rated value	
Emitter	Forward current	I_F	50 mA (see note 1)
	Pulse forward current	I_{FP}	1 A (see note 2)
	Reverse voltage	V_R	4 V
Detector	Collector–Emitter voltage	V_{CEO}	30 V
	Emitter–Collector voltage	V_{ECO}	---
	Collector current	I_C	20 mA
	Collector dissipation	P_C	100 mW (see note 1)
Ambient temperature	Operating	T_{opr}	–25°C to 85°C
	Storage	T_{stg}	–30°C to 100°C
Soldering temperature	T_{sol}	260°C (see note 3)	

Note: 1. Refer to the temperature rating chart if the ambient temperature exceeds 25°C.

2. The pulse width is 10 μ s maximum with a frequency of 100 Hz.
3. Complete soldering within 10 seconds.

■ Ordering Information

Description	Aperture (a x b)	Model
Photomicrosensor (transmissive)	2.1 x 0.5	EE-SH3(-B)
	2.1 x 1.0	EE-SH3-C(S)
	2.1 x 0.2	EE-SH3-D(S)
	0.5 x 2.1	EE-SH3-G(S)

■ Electrical and Optical Characteristics (Ta = 25°C)

Item	Symbol	Value				Condition	
		EE-SH3(-B)	EE-SH3-C(S)	EE-SH3-D(S)	EE-SH3-G(S)		
Emitter	Forward voltage	V_F	1.2 V typ., 1.5 V max.			$I_F = 30$ mA	
	Reverse current	I_R	0.01 μ A typ., 10 μ A max.			$V_R = 4$ V	
	Peak emission wavelength	λ_P	940 nm typ.			$I_F = 20$ mA	
Detector	Light current	I_L	0.5 to 14 mA typ.	1 to 28 mA typ.	0.1 mA min.	0.5 to 14 mA	$I_F = 20$ mA, $V_{CE} = 10$ V
	Dark current	I_D	2 nA typ., 200 nA max.			$V_{CE} = 10$ V, 0 lx	
	Leakage current	I_{LEAK}	---			---	
	Collector–Emitter saturated voltage	$V_{CE(sat)}$	0.1 V typ., 0.4 V max.		---	0.1 V typ., 0.4 V max.	$I_F = 20$ mA, $I_L = 0.1$ mA
	Peak spectral sensitivity wavelength	λ_P	850 nm typ.			$V_{CE} = 10$ V	
Rising time	t_r	4 μ s typ.				$V_{CC} = 5$ V, $R_L = 100$ Ω ,	
Falling time	t_f	4 μ s typ.				$I_L = 5$ mA	

■ Engineering Data

Forward Current vs. Collector Dissipation Temperature Rating

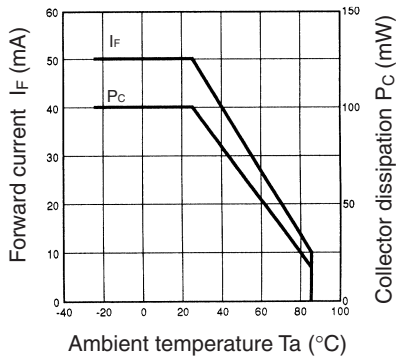

Forward Current vs. Forward Voltage Characteristics (Typical)

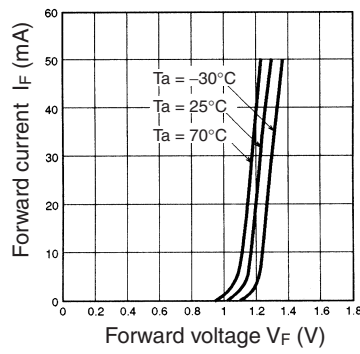

Light Current vs. Forward Current Characteristics (Typical)

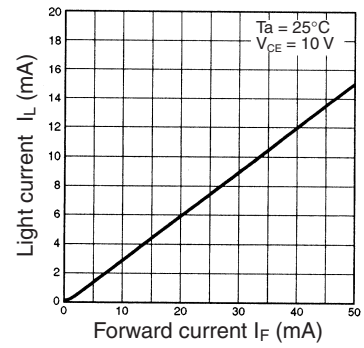

Light Current vs. Collector-Emitter Voltage Characteristics (EE-SH3(-B))

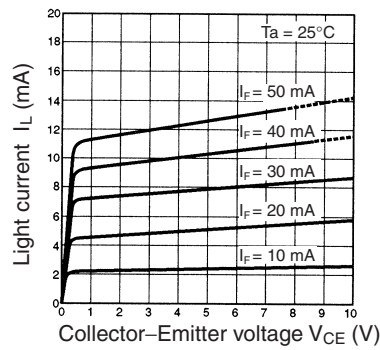

Relative Light Current vs. Ambient Temperature Characteristics (Typical)

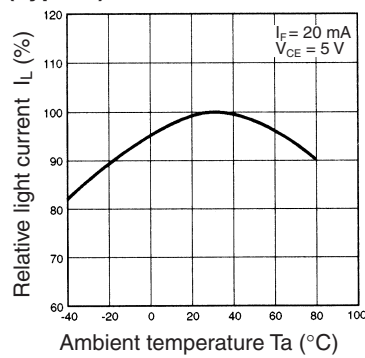

Dark Current vs. Ambient Temperature Characteristics (Typical)

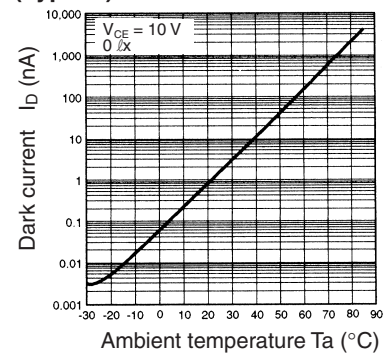

Response Time vs. Load Resistance Characteristics (Typical)

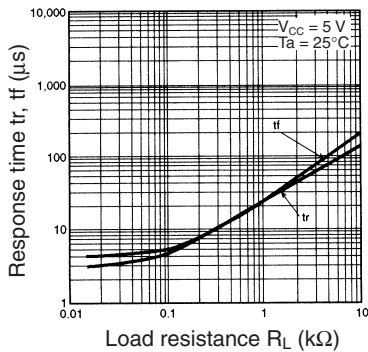

Sensing Position Characteristics (EE-SH3-D(S))

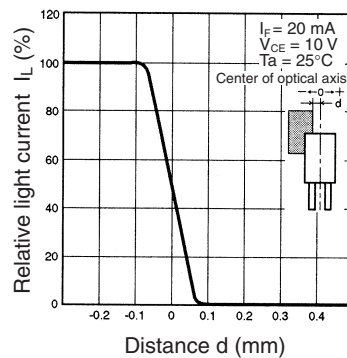

Sensing Position Characteristics (EE-SH3(-B))

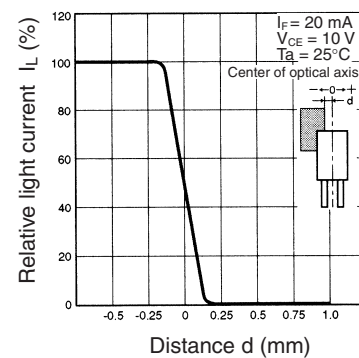

Sensing Position Characteristics (EE-SH3-G(S))

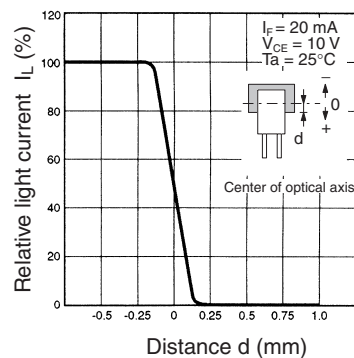

Sensing Position Characteristics (EE-SH3-C(S))

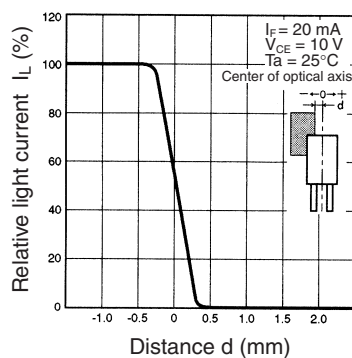

Response Time Measurement Circuit

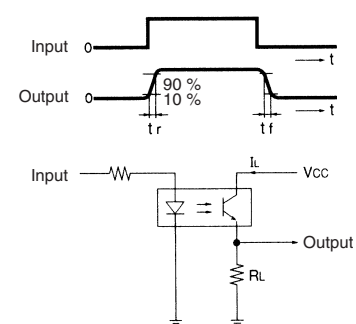

A large grid of 20 columns and 30 rows of small squares, used for taking notes or drawing. The grid is composed of thin, light gray lines forming a uniform pattern across the page.

All sales are subject to Omron Electronic Components LLC standard terms and conditions of sale, which can be found at http://www.components.omron.com/components/web/webfiles.nsf/sales_terms.html

ALL DIMENSIONS SHOWN ARE IN MILLIMETERS.
To convert millimeters into inches, multiply by 0.03937. To convert grams into ounces, multiply by 0.03527.

OMRON[®]

**OMRON ELECTRONIC
COMPONENTS LLC**

55 E. Commerce Drive, Suite B
Schaumburg, IL 60173

847-882-2288

OMRON ON-LINE

Global - <http://www.omron.com>

USA - <http://www.components.omron.com>

Mouser Electronics

Authorized Distributor

Click to View Pricing, Inventory, Delivery & Lifecycle Information:

Omron:

[EE-SH3-B](#) [EE-SH3-CS](#) [EE-SH3-D](#) [EE-SH3-DS](#) [EE-SH3-G](#) [EE-SH3-GS](#) [EE-SH3](#)