

# Compact Non-Contact Door Switch/Non-Contact Door Switch Controller D40A/G9SX-NS

## Electronic Detection Mechanism for Better Stability in Non-contact Door Switch Operation

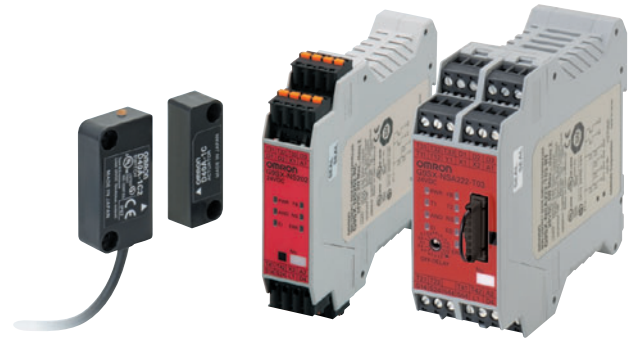

Connection is also possible to a G9SP Safety Controller.

- Complies with ISO 13849-1 (PLd/Safety Category 3).
- The maximum number of Switches that can be connected to a G9SPseries Controller is given below.
  - G9SP-N10S: 15 × 1 system
  - G9SP-N10D/20S: 15 × 2 system

For details, refer to the *G9SP Series Operation Manual* (Cat. No. Z922).

For the most recent information on models that have been certified for safety standards, refer to your OMRON website.

**!** Be sure to read the "Safety Precautions" on page 28 and the "Precautions for All Safety Door Switches".

## Features

### Easy-to-see 2-Color Indicators

Switch status is easy to see at a glance with these red/yellow LED indicators.



Red: Open door detected.  
Yellow: Closed door detected.  
Not lit: Power OFF or failure

### Mount from Either Side

Mount from whichever side provides the easiest wiring path to enable mounting to all types of doors.



Swinging doors

Sliding doors

### Small Actuator

An actuator that is smaller than the switch saves space, even inside the door. Even when mounted with an L-bracket, the actuator's height will not hinder installation or operation.

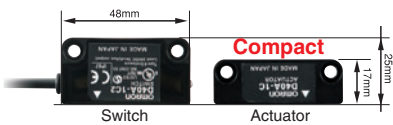

### Save Labor with Connector and Reduce Inventory

Wiring time can be reduced with the connector. Cable lengths can be selected, and only cables of required lengths can be purchased. Switches can be integrated into a single Switch with a connector when installing in a machine with multiple doors or various types of machines, which can reduce inventory.



### Connect Up to 30 Switches to a Single Controller

Reduce costs by connecting up to 30 Switches to a single Controller.

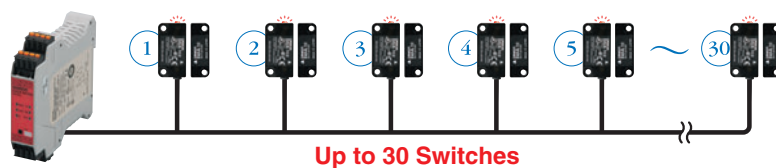

Up to 30 Switches

## Solves Conventional Switch Issues to Provide Stable Detection

**Issue 1** The Switch does not accurately detect the door when it is closed slowly, resulting in an error.

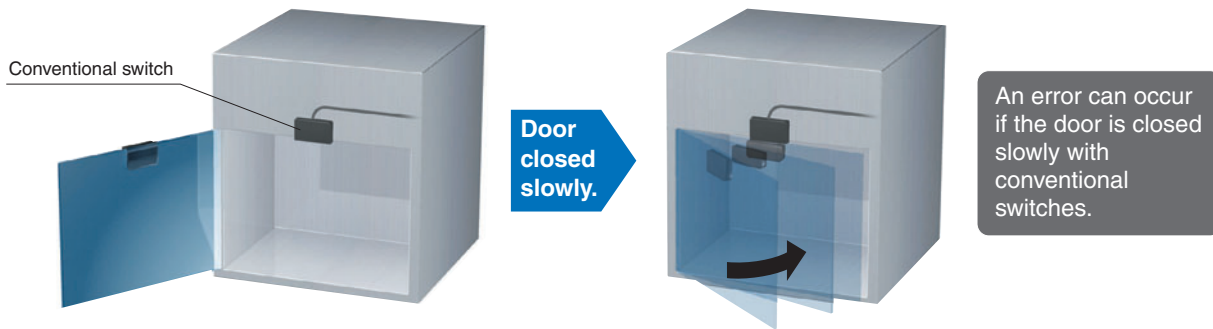

### Solution 1 Conventional Switches

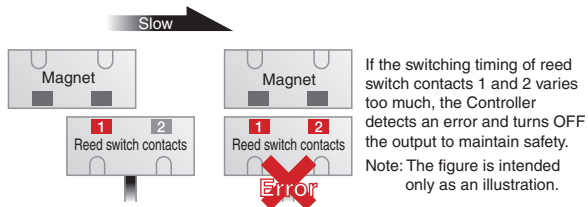

**Stable Detection with the D40A's New System**

The D40A does not use reed switches and provides stable detection with electronic switches.

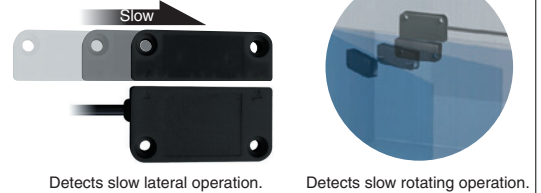

**Issue 2** It is nearly impossible to tell which door is open in a multi-door application.

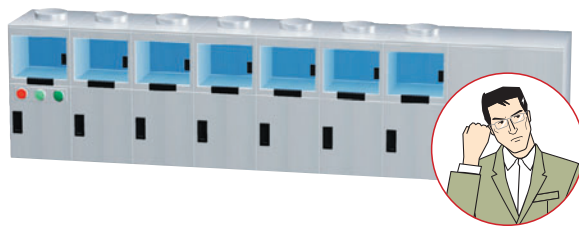

**If an error occurs...**

The system cannot be started because the Controller has turned OFF the output even though all doors appear to be closed.

It's impossible to tell if there is a door open or if an error has occurred.

All doors must be opened and closed before operation can be started.

### Solution 2

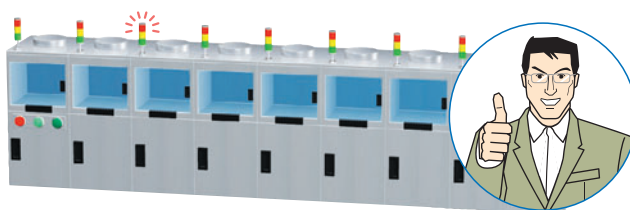

**With the D40A...**

The auxiliary outputs can be used to easily indicate which door is open. And with two-color indicators, mounting adjustments are also easy. The D40A is the first Non-contact Door Switch to combine 2-color indicators, auxiliary outputs, and 30-switch connection capacity, allowing you to create a better safety environment.

**Issue 3** Various cable lengths and complex wiring are required for multiple doors.

### Solution 3

The model with a connector allows you to select the cable lengths that are connected and purchase the cables of required lengths. Switches can be integrated into a single Switch with a connector. Downtime can be reduced by replacing the cable and switch partially at maintenance time.



## Two Types of Controller to Solve Productivity, Expandability, and Maintenance Issues

The G9SX-NS and G9SX-NSA are designed specifically for use with Non-contact door switch, and with the G9SX-NSA you can also connect mechanical safety door switches. Among other features, these Controllers support logical AND connections that enable partial stops. These Controllers make the most of D40A Switches.

### Two Different Controllers

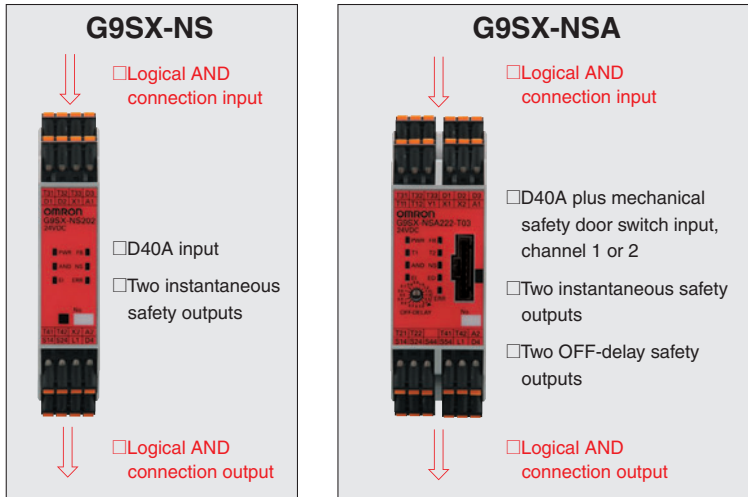

### Indicators That Make Maintenance Easier

The indicators show the location and cause of wiring errors and any other errors that are detected. Auxiliary outputs for errors also contribute to reducing down time.

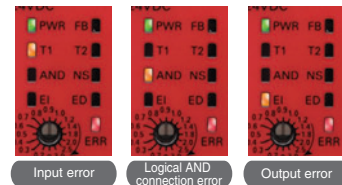

### Mechanical Safety Door Switches Can Also Be Connected with the G9SX-NSA

Inputs can be accepted from both D40A Switches and mechanical switches to reduce the number of Controllers and costs.

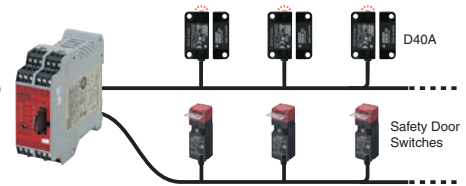

### Expansion Units to Easily Increase the Number of Outputs with the G9SX-NSA

The number of outputs can be easily increased using connectors. Up to 25 outputs can be configured.



## Reduce Costs with these New-Concept Controllers

### Issue 1 Two Controllers are required for emergency stop switches and non-contact door switches.

#### Application

- One hazard.
- The system must be stopped when either a door is opened or an emergency stop switch is pressed.

The G9SA must be added to connect the emergency stop switch.

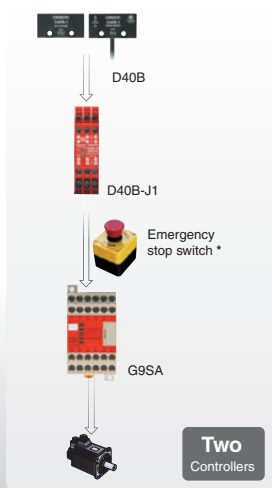

#### Solution 1

The D40A Simplifies the Configuration

With only one G9SX-NSA222-T03□ Controller, both a Non-contact Door Switch and an emergency stop switch can be connected.

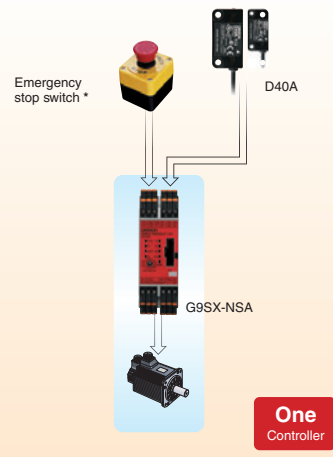

### Issue 2 Another Controller has to be added to use an OFF-delay timer.

#### Application

- Two hazards.
- The power supply must be turned OFF immediately when the emergency stop switch is pressed.
- When a door is opened, a stop signal is sent to only servomotor B and then the power supply is turned OFF.

The G9SA must be added to use an OFF-delay timer.

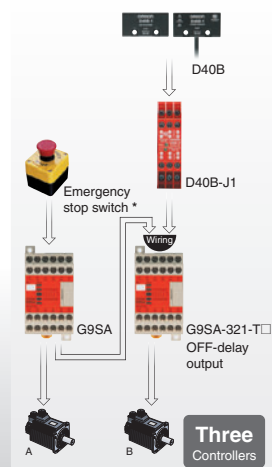

#### Solution 2

The D40A Simplifies the Configuration

A Controller can be eliminated because the G9SX-NSA222-T03□ provides an OFF-delay output.

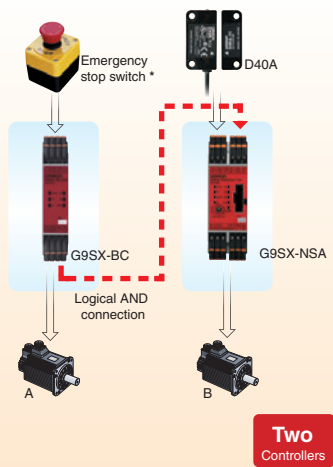

\* Always use a manual reset when using an emergency stop.

Refer to G9SX for the features of the G9SX Series.

## Selection of Safety Controllers for D40A

### [Connectable Controllers]

Safety Controller G9SP

Non-contact Door Switch Controller G9SX-NS □

### Safety Controller G9SP

- Flexible programming by combining function blocks
- Extensive system configurations
- Decreased work hours by convenient configurator

#### Function Blocks

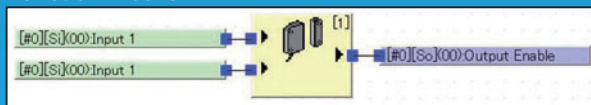

### Non-contact Door Switch Controller G9SX-NS □

- Easy expansion of output points by an expansion unit
- Improved maintainability by LED display
- No special programming required



Note: For product information, refer to the website at:  
<http://www.ia.omron.com/>

## Model Number Structure

### Model Number Legend

#### Non-Contact Door Switch (Switch/Actuator)

D40A - □□□  
 1 2 3

**1. Type**

1: Standard model

**2. Auxiliary outputs**

C: 1NO (PNP transistor output)

**3. Cable length**

2: 2 m  
 5: 5 m  
 015-F: Connector type  
 (Cable length :15cm)

#### Non-Contact Door Switch Controller

G9SX - □□□□□□ - □□□ - □□  
 1 2 3 4 5 6

**1. Functions**

NS/NSA: Controller  
 EX: Expansion Unit

**2. Output Configuration (Instantaneous Safety Outputs)**

2: 2 outputs  
 4: 4 outputs

**3. Output Configuration (OFF-delayed Safety Outputs)**

0: None  
 2: 2 outputs

**4. Output Configuration (Auxiliary Outputs)**

1: 1 output  
 2: 2 outputs

**5. Max. OFF-delay Time**

Controller  
 T03: 3 s (Variable)  
 Expansion Unit  
 Blank: No OFF delay  
 T: OFF delay

**6. Terminal Block Type**



RT: Screw terminals  
 RC: Spring-cage terminals

For product information of G9SP, refer to the website at: <http://www.ia.omron.com/>

## Ordering Information

### List of Models

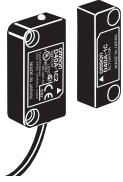
#### Non-Contact Door Switches (Switch/Actuator)

| Classification  | Appearance  | Auxiliary outputs        | Cable length | Model           |
|-----------------|---|--------------------------|--------------|-----------------|
| Standard models |  | Semiconductor outputs *1 | 2 m          | D40A-1C2        |
|                 |   |                          | 5 m          | D40A-1C5        |
| Connector model |  |                          | 0.15 m       | D40A-1C015-F *2 |

\*1. PNP open-collector semiconductor output.

\*2. The model with a connector is not KOSHA certified.

#### Cable with connector

| Connector Type | Cable Length | Model           | Packing Unit |
|----------------|--------------|-----------------|--------------|
| Single-end     | 2 m          | XS2F-D521-DG0-A | 5            |
|                | 5 m          | XS2F-D521-GG0-A | 5            |
|                | 10 m         | XS2F-D521-JG0-A | 1            |
|                | 15 m         | XS2F-D521-KG0-A | 1            |
|                | 20 m         | XS2F-D521-LG0-A | 1            |

| Connector Type | Cable Length | Model           | Packing Unit |
|----------------|--------------|-----------------|--------------|
| Double-end     | 2 m          | XS2W-D521-DG1-A | 5            |
|                | 5 m          | XS2W-D521-GG1-A | 5            |
|                | 10 m         | XS2W-D521-JG1-A | 1            |
|                | 15 m         | XS2W-D521-KG1-A | 1            |
|                | 20 m         | XS2W-D521-LG1-A | 1            |

#### Non-Contact Door Switch Controllers

| Safety outputs *1   |                       | Auxiliary outputs *3 | Logical AND connection input | Logical AND connection output | Max. OFF delay time *4 | Rated voltage | Terminal block type   | Model              |
|---------------------|-----------------------|----------------------|------------------------------|-------------------------------|------------------------|---------------|-----------------------|--------------------|
| Instantaneous       | OFF-delayed *2        |                      |                              |                               |                        |               |                       |                    |
| 2 (Semi-conductors) | 0                     | 2 (Semi-conductors)  | 1                            | 1                             | ---                    | 24 VDC        | Screw terminals       | G9SX-NS202-RT      |
|                     | 2 (Semiconductors)    |                      |                              |                               |                        |               | Spring-cage terminals | G9SX-NS202-RC      |
|                     |                       |                      |                              |                               |                        |               | 3.0 s                 | Screw terminals    |
|                     | Spring-cage terminals |                      |                              |                               |                        |               |                       | G9SX-NSA222-T03-RC |

\*1. P channel MOS FET transistor output

\*2. The OFF-delayed output becomes an instantaneous output by setting the OFF-delay time to 0 s.

\*3. PNP transistor output

\*4. The OFF-delay time can be set in 16 steps as follows:

0/0.2/0.3/0.4/0.5/0.6/0.7/0.8/0.9/1.0/1.2/1.4/1.8/2.0/2.5/3.0 s

#### Expansion Units

| Safety outputs |             | Auxiliary outputs    | OFF-delay time        | Rated voltage | Terminal block type | Model                 |                 |
|----------------|-------------|----------------------|-----------------------|---------------|---------------------|-----------------------|-----------------|
| Instantaneous  | OFF-delayed |                      |                       |               |                     |                       |                 |
| 4PST-NO        | ---         | 1 (Semiconductor) *1 | ---                   | 24 VDC        | Screw terminals     | G9SX-EX401-RT         |                 |
| ---            | 4PST-NO     |                      | Spring-cage terminals |               | *2                  | Spring-cage terminals | G9SX-EX401-RC   |
|                |             |                      | Screw terminals       |               |                     | Screw terminals       | G9SX-EX041-T-RT |
|                |             |                      | Spring-cage terminals |               |                     | Spring-cage terminals | G9SX-EX041-T-RC |

\*1. PNP transistor output

\*2. The OFF-delay time is synchronized to the OFF-delay time setting in the connected Controller (G9SX-NSA222-T03-□).

## Accessories

### Terminal Block

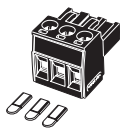
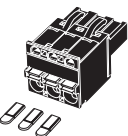
| Appearance *  | Specifications                                    | Applicable units     | Model                | Remarks   |
|---|---|----------------------|----------------------|---|
|  | Terminal Block with screw terminals (3-pin)       | G9SX-NSA             | <b>Y9S-03T1B-02A</b> | Two Terminal Blocks (black) with screw terminals, and a set of six code marks to prevent erroneous insertion.       |
|   | Terminal Block with screw terminals (4-pin)       | G9SX-NS<br>G9SX-EX-□ | <b>Y9S-04T1B-02A</b> | Two Terminal Blocks (black) with screw terminals, and a set of six code marks to prevent erroneous insertion.       |
|  | Terminal Block with spring-cage terminals (3-pin) | G9SX-NSA             | <b>Y9S-03C1B-02A</b> | Two Terminal Blocks (black) with spring-cage terminals, and a set of six code marks to prevent erroneous insertion. |
|   | Terminal Block with spring-cage terminals (4-pin) | G9SX-NS<br>G9SX-EX-□ | <b>Y9S-04C1B-02A</b> | Two Terminal Blocks (black) with spring-cage terminals, and a set of six code marks to prevent erroneous insertion. |

**Note:** The G9SX main unit comes with a terminal block as standard equipment. The accessories shown here can be ordered as a replacement.

\* The illustrations show 3-pin types

## Specifications

### Non-contact Door Switches

#### Ratings and Characteristics

| Item   | Model                           | D40A-1C□  |
|--|---------------------------------|---|
| Operating characteristics *1                           | Operating distance OFF→ON       | 5 mm min.   |
|  | Operating distance ON→OFF       | 15 mm max.  |
|  | Differential travel             | 20% or less of operating distance at 23°C (maximum 2.5 mm)                  |
|  | Influence of temperature (max.) | ±20% of operating distance at 23°C, within temperature range of -10 to 55°C |
|  | Repeat accuracy                 | ±10% or less of operating distance at 23°C                                  |
| Ambient operating temperature                          |                                 | -10 to 55°C (no icing or condensation)                                      |
| Ambient operating humidity                             |                                 | 25% to 85%  |
| Insulation resistance (between charged parts and case) |                                 | 50 MΩ max. (at 500 VDC)   |
| Dielectric strength (between charged parts and case)   |                                 | 1,000 VAC for 1 min   |
| Pollution degree                                       |                                 | 3   |
| Electromagnetic compatibility                          |                                 | IEC/EN 60497-5-3 compliant  |
| Vibration resistance                                   |                                 | 10 to 55 to 10 Hz (single amplitude: 0.75 mm, double amplitude: 1.5 mm)     |
| Shock resistance                                       |                                 | 300 m/s <sup>2</sup> min.   |
| Degree of protection                                   |                                 | IP67  |
| Material   |                                 | PBT resin   |
| Mounting method  |                                 | M4 screws   |
| Terminal screw tightening torque                       |                                 | 1 N·m   |
| Power supply voltage                                   |                                 | 24 VDC +10%/-15%  |
| Power consumption                                      |                                 | 0.6 W max.  |
| Auxiliary outputs *2                                   |                                 | 24 VDC, 10 mA (PNP open-collector outputs)                                  |
| LED indicators   |                                 | Actuator not detected (red); actuator detected (yellow)                     |
| Connection cables                                      |                                 | 2 m, 5 m, 0.15m (Connector type)  |
| Number of connectable switches                         |                                 | 30 max. (wiring length: 100 m max.) *3                                      |
| Weight   |                                 | Switch: approx. 145 g, actuator: approx. 20 g (D40A-1C2)                    |

\*1. This is the distance where the switch operates from OFF to ON when approaching and the distance where the switch operates from ON to OFF when separating when the switch and actuator target marks are on the same axis, and the sensing surfaces coincide.

\*2. Turns ON when the actuator is approaching. The G3R series of the SSR can be driven at an auxiliary output of 10 mA. Contact your OMRON representative for details.

\*3. For details, refer to item 5 on page 29.

## Non-contact Door Switches Ratings

### Power input

| Item                      | Model | G9SX-NS202-□                        | G9SX-NSA222-T03-□ | G9SX-EX-□ |
|---------------------------|-------|-------------------------------------|-------------------|-----------|
| Rated supply voltage      |       | 24 V DC                             |                   |           |
| Operating voltage range   |       | -15% to 10% of rated supply voltage |                   |           |
| Rated power consumption * |       | 3 W max.                            | 4 W max.          | 2 W max.  |

\* Power consumption of loads not included.

### Inputs

| Item                 | Model | G9SX-NS202-□/G9SX-NSA222-T03-□   |
|----------------------|-------|--|
| Safety input *1      |       | Operating voltage: 20.4 VDC to 26.4 VDC, internal impedance: approx. 2.8 kΩ *2 |
| Feedback/reset input |       |  |

\*1. Only applies to the G9SX-NSA222-T03-□. Refers to input other than that from the Non-contact Door Switch.

\*2. Provide a current equal to or higher than that of the minimum applicable load of the connected input control device.

### Outputs

| Item   | Model | G9SX-NS202-□/G9SX-NSA222-T03-□  |
|--|-------|---|
| Instantaneous safety output *1<br>OFF-delayed safety output *1 |       | P channel MOS FET transistor output<br>Load current: 0.8 A DC max. *2 |
| Auxiliary output   |       | PNP transistor output<br>Load current: 100 mA max.                    |

\*1. While safety outputs are in the ON state, the following signal sequence is output continuously for diagnosis.

When using the safety outputs as input signals to control devices (i.e. Programmable Controllers), consider the OFF pulse shown below.

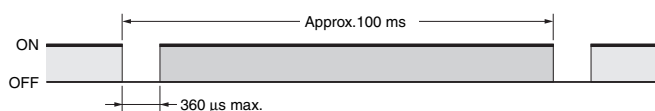

\*2. The following derating is required when Units are mounted side-by-side.

G9SX-NS202-□/G9SX-NSA222-T03-□: 0.4 A max. load current

### Expansion Unit

| Item                      | Model | G9SX-EX-□                                 |
|---------------------------|-------|---|
| Rated load                |       | 250 VAC, 3 A/30 VDC, 3 A (resistive load) |
| Rated carry current       |       | 3 A                                       |
| Maximum switching voltage |       | 250 VAC, 125 VDC                          |



## Characteristics

| Item   | Model  | G9SX-NS202-□  | G9SX-NSA222-T03-□   | G9SX-EX-□   |
|--|--|---|---|---|
| Over-voltage category (IEC/EN 60664-1)   |  | II  |   | II (Relay outputs 13 to 43 and 14 to 44: III)                           |
| Operating time (OFF to ON state) *1  |  | 100 ms max. (Logical AND connection input ON and Non-contact Door Switch input ON)                  | 50 ms max. (Safety input: ON) *2<br>100 ms max. (Logical AND connection input ON and Non-contact Door Switch input ON) *3 | 30 ms max. *4   |
| Response time (ON to OFF state) *1   |  | 15 ms max. (Logical AND connection input: OFF)<br>20 ms max. (Non-contact Door Switch input OFF) *6 | 15 ms max. (Safety input OFF and logical AND connection input OFF)<br>20 ms max. (Non-contact Door Switch input: OFF) *6  | 10 ms max. *4   |
| ON-state residual voltage  |  | 3.0 V max. (safety output, auxiliary output)  |   |   |
| OFF-state leakage current  |  | 0.1 mA max. (safety output, auxiliary output)   |   |   |
| Maximum wiring length of safety input, logical AND connection input, and Non-contact Door Switch input |  | 100 m max. (External connection impedance: 100 Ω max. and 10 nF max.)                               |   |   |
| Reset input time (Reset button pressing time)  |  | 100 ms min.   |   |   |
| Accuracy of OFF-delay time *5  |  | ---   | Within ±5% of the set value   | Within ±5% of the set value   |
| Insulation resistance  | Between logical AND connection terminals, and power supply input terminals and other input and output terminals connected together | 20 MΩ min. (at 100 VDC)   |   | ---   |
|  | Between all terminals connected together and DIN rail  |   |   | 100 MΩ min. (at 500 VDC)  |
| Dielectric strength  | Between logical AND connection terminals, and power supply input terminals and other input and output terminals connected together | 500 VAC for 1 min.  |   | ---   |
|  | Between all terminals connected together and DIN rail  |   |   | 1,200 VAC for 1 min   |
|  | Between different poles of outputs   |   |   | ---   |
|  | Between relay outputs connected together and other terminals connected together  |   |   | 2,200 VAC for 1 min   |
| Vibration resistance   |  | 10 to 55 to 10 Hz, 0.375 mm single amplitude (0.75 mm double amplitude)                             |   |   |
| Shock resistance   | Destruction  | 300 m/s <sup>2</sup>  |   |   |
|  | Malfunction  | 100 m/s <sup>2</sup>  |   |   |
| Durability   | Electrical   | ---   |   | 100,000 cycles min. rated load, switching frequency: 1,800 cycles/hour) |
|  | Mechanical   | ---   |   | 5,000,000 cycles min. (switching frequency: 7,200 cycles/hour)          |
| Ambient operating temperature  |  | -10 to 55°C (no icing or condensation)  |   |   |
| Ambient operating humidity   |  | 25% to 85%  |   |   |
| Terminal tightening torque   |  | 0.5 N·m (For the G9SX-NS□-RT (with screw terminals) only)   |   |   |
| Weight   |  | Approx. 125 g   | Approx. 200 g   | Approx. 165 g   |

\*1. When two or more Units are connected by logical AND, the operating time and response time are the sum total of the operating times and response times, respectively, of all the Units connected by logical AND.

\*2. Represents the operating time when the safety input turns ON with all other conditions set.

\*3. Represents the operating time when the logical AND input and the Non-contact Door Switch input turn ON with all other conditions set.

\*4. This does not include the operating time or response time of G9SX-NS□ that are connected.

\*5. This does not include the operating time or response time of internal relays in the G9SX-EX-□.

\*6. The failure detection time for 24 V short-circuit failure on the input to Non-contact Door Switches is 35 ms max.

If using the Switch for an application other than as a Door Switch, calculate the safe distance using a failure detection time of 35 ms.

For product information of G9SP, refer to the website at: <http://www.ia.omron.com/>

## Cable with connector

### Ratings and Characteristics

|                                     |   |
|-------------------------------------|---|
| Rated current                       | 3 A   |
| Rated voltage                       | For DC 125 VDC, for AC 250 VAC                    |
| Contact resistance (Connector)      | 40 mΩ max. (20 mV max., 100 mA max.)              |
| Insulation resistance               | 1,000 MΩ min. (at 500 VDC)                        |
| Dielectric strength (Connector)     | 1,500 VAC for 1 min (leakage current: 1 mA max.). |
| Degree of protection                | IP67 (IEC529)                                     |
| Insertion tolerance                 | 200 times min.                                    |
| Assembled fixture strength          | Tensile: 98 N/15 s<br>Torsion: 0.98 N-m/15 s      |
| Cable holding strength              | Cable diameter: 6 mm 98 N/15 s                    |
| Ambient operating temperature range | Operating: -25°C to 70°C                          |
| Ambient humidity range              | 20% to 85%  |

### Materials and Finish

| Item                  |           | XS2F/H/W                              |
|-----------------------|-----------|---------------------------------------|
| Contacts              | Materials | Phosphor bronze                       |
|                       | Finish    | Nickel base, 0.4-μm gold plating      |
| Thread bracket        | Materials | Brass                                 |
|                       | Finish    | Nickel plated                         |
| Pin block             | Materials | PBT resin (UL94V-0)                   |
|                       | Finish    | For DC: light gray; for AC: dark gray |
| O-ring/rubber bushing |           | Rubber                                |
| Cover                 |           | PBT resin (UL94V-0)                   |

### Logical AND Connection

| Item   | Model | G9SX-NS202-□  | G9SX-NSA222-T03-□ | G9SX-EX-□    |
|--|-------|---------------|-------------------|--------------|
| Number of Units connected per logical AND output   |       | 4 Units max.  |                   | ---          |
| Total number of Units connected by logical AND *1  |       | 20 Units max. |                   | ---          |
| Number of Units connected in series by logical AND |       | 5 Units max.  |                   | ---          |
| Max. number of Expansion Units connected *2        |       |               | ---               | 5 Units max. |
| Maximum cable length for logical AND input         |       | 100 m max.    |                   | ---          |

**Note:** See Logical AND Connection Combinations below for details.

\*1. The number of G9SX-EX401-□ Expansion Units or G9SX-EX041-T-□ Expansion Units (OFF-delayed Model) not included.

\*2. G9SX-EX401-□ Expansion Units and G9SX-EX041-T-□ Expansion Units (OFF-delayed Model) can be mixed.

### Logical AND Connection Combinations

1. One logical AND connection output from a G9SX-NS□ Controller can be logical AND connected to up to four Controllers.

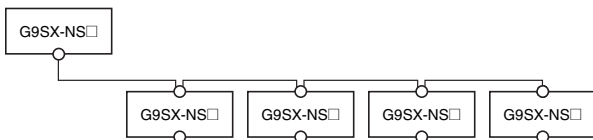

2. Any G9SX-NS□ Controller that receives a logical AND connection input can be logically connected to other Controllers on up to five layers.

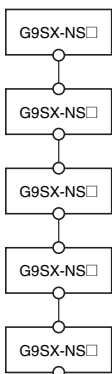

**Note:** The G9SX-NS□ in the above diagram can be replaced by the G9SX-AD□ Advanced Unit. For details on G9SX-AD□ Advanced Units, refer to the G9SX-series Flexible Safety Unit catalog. (Cat. No. J150).

3. The largest possible system configuration contains a total of 20 G9SX-NS□ Controllers, G9SX-AD□ Advanced Units, and G9SX-BC Basic Units. In this configuration, each Controller or Advanced Unit can have up to five Expansion Units.

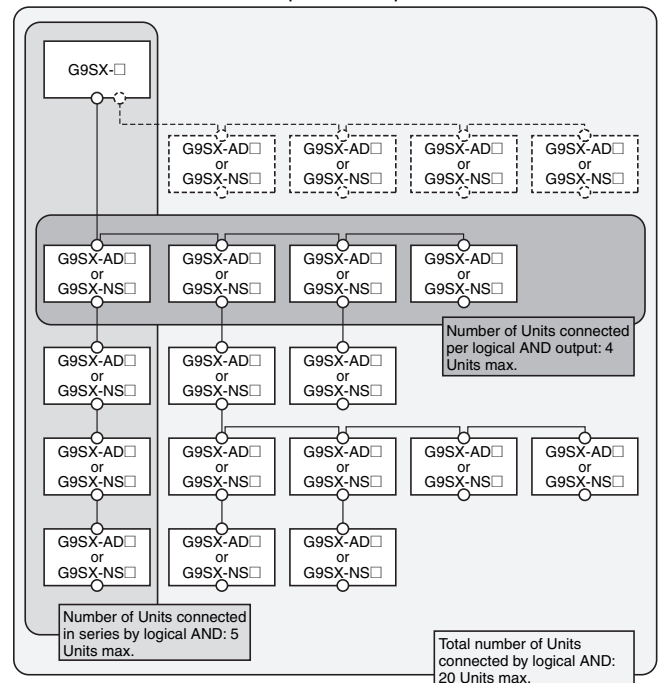

## Response Time and Operating Time

### 1. G9SX-NS□

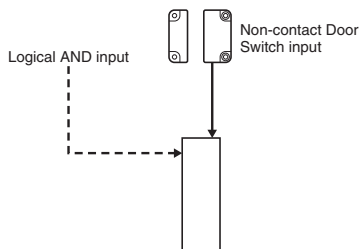

|                               | Max. response time (excluding Expansion Units) *1 | Max. operating time (excluding Expansion Units) *2 |
|-------------------------------|---|--|
| Non-contact Door Switch input | 20 ms   | 100 ms   |
| Logical AND input             | 15 ms   | 100 ms   |

\*1. The maximum response time is the time it takes the output to switch from ON to OFF after the input switches from ON to OFF.

\*2. The maximum operating time is the time it takes the output to switch from OFF to ON after the input switches from OFF to ON.

### 2. G9SX-NSA□

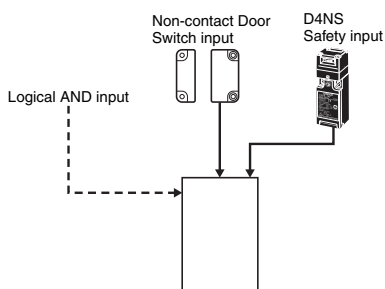

|                               | Max. response time (excluding Expansion Units) *1 | Max. operating time (excluding Expansion Units) *2 |
|-------------------------------|---|--|
| Non-contact Door Switch input | 20 ms   | 100 ms   |
| Safety input                  | 15 ms   | 50 ms  |
| Logical AND input             | 15 ms   | 100 ms   |

\*1. The maximum response time is the time it takes the output to switch from ON to OFF after the input switches from ON to OFF.

\*2. The maximum operating time is the time it takes the output to switch from OFF to ON after the input switches from OFF to ON.

### 3. Multiple G9SX-NS□/NSA□ Non-contact Door Switch Controllers

When multiple Controllers are logically connected with AND connections, the response time is the sum of the response times given in 1 and 2 above. (It is the same for the operating time.)

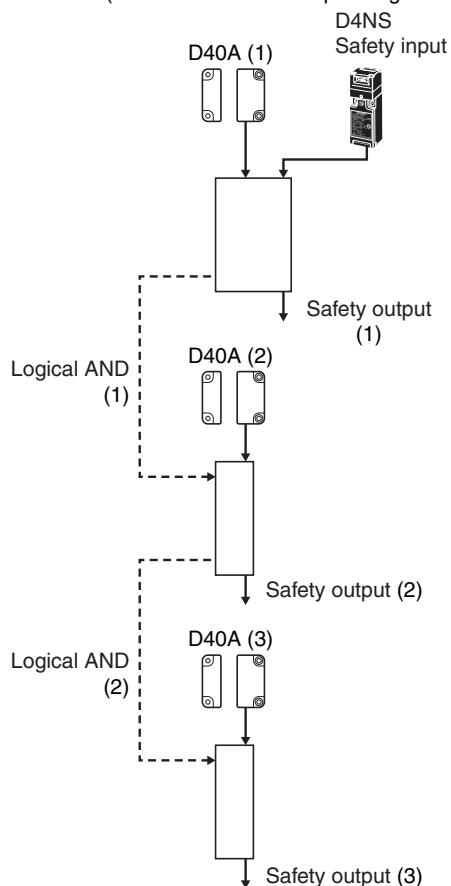

#### Case 1

Response Time from When D40A (1) Turns from ON to OFF until Safety Output (2) Turns from ON to OFF

$$20 \text{ ms (D40A (1))} + 15 \text{ ms (Logical AND connection (1))} = 35 \text{ ms}$$

#### Case 2

Response Time from When D4NS Turns from ON to OFF until Safety Output (3) Turns from ON to OFF

$$15 \text{ ms (D4NS)} + 15 \text{ ms (Logical AND connection (1))} + 15 \text{ ms (Logical AND connection (2))} = 45 \text{ ms}$$

# Engineering Data

## Guaranteed value and typical data of operating characteristics

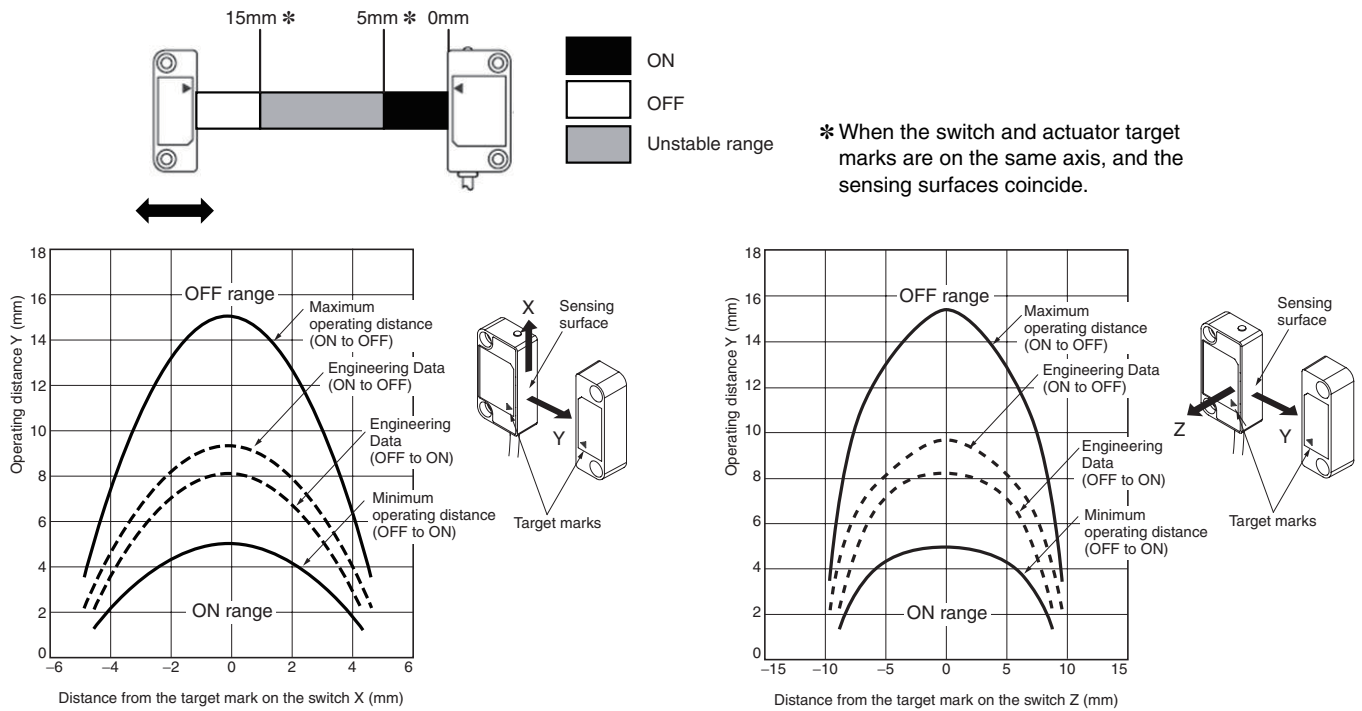

- Note:**
1. The operating distance is the distance between the switch and actuator sensing surfaces.
  2. Data in the diagram is typical data at an ambient temperature of 23°C. Actual operating values may vary. The operating distance may be affected by ambient metal, magnet catches, and temperature.

## Connections

### Internal Connection

#### G9SX-NS202-□ (Non-contact Door Switch Controller)

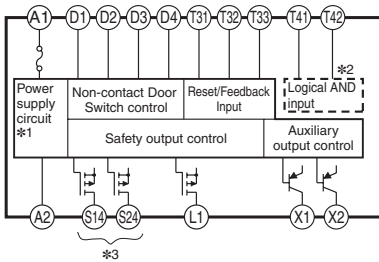

- \*1. Internal power supply circuit is not isolated.
- \*2. Logical AND input is isolated.
- \*3. Outputs S14 to S24 are internally redundant.

#### G9SX-EX401-□/ G9SX-EX041-T-□ (Expansion Unit/Expansion Unit OFF-delayed Model)

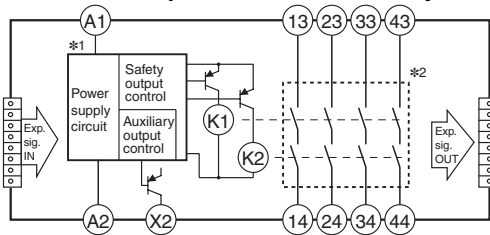

- \*1. Internal power supply circuit is not isolated.
- \*2. Relay outputs are isolated.

#### G9SX-NSA222-T03-□ (Non-contact Door Switch Controller)

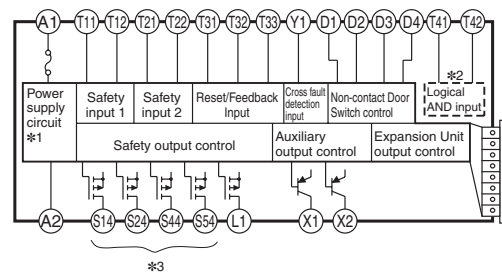

- \*1. Internal power supply circuit is not isolated.
- \*2. Logical AND input is isolated.
- \*3. Outputs S14 to S54 are internally redundant.

### Internal Circuit Diagram

#### D40A-1C□

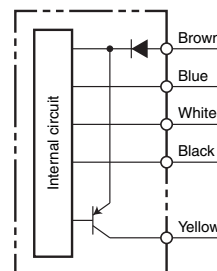

# Dimensions and Terminal Arrangement

## Non-contact Door Switch (Switch/Actuator)

D40A-1C2  
D40A-1C5  
D40A-1C015-F

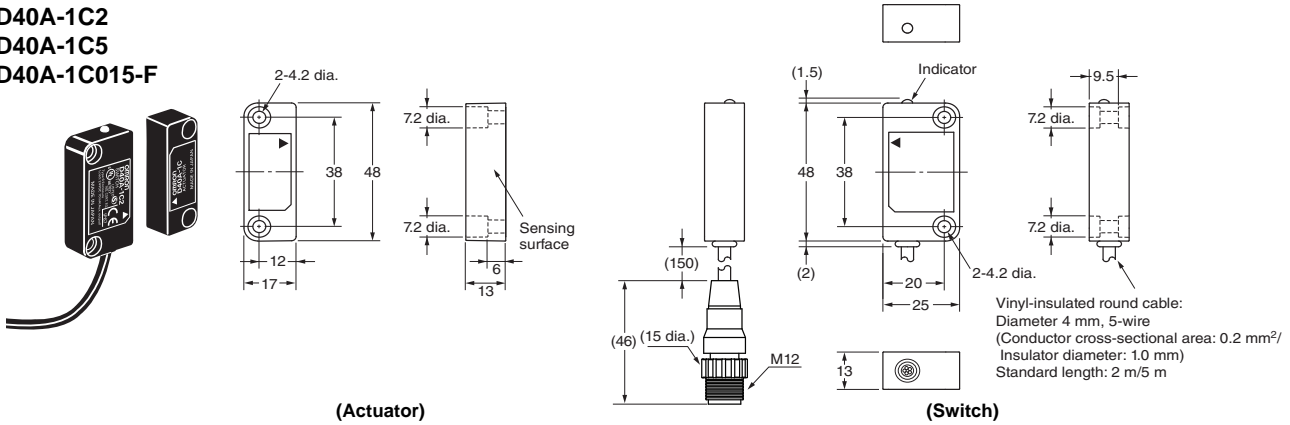

## Non-contact Door Switch Controller

G9SX-NS202-□

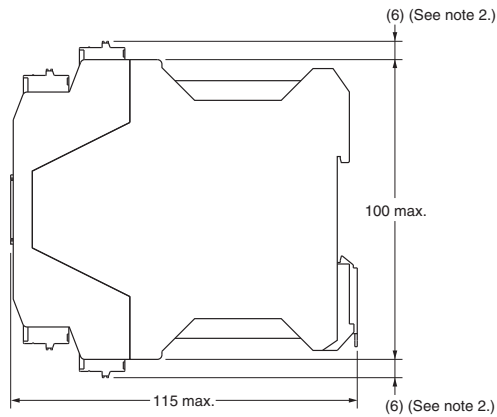
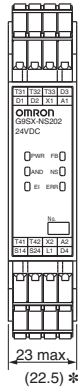
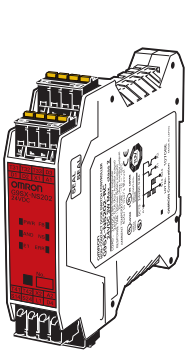

### Terminal arrangement

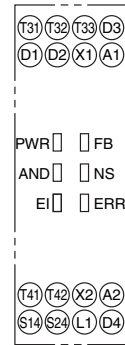

**Note: 1.** Above outline drawing is for models with spring-cage terminals (-RC).  
**2.** For models with spring-cage terminals (-RC) only.

\* Typical dimension

## Non-contact Door Switch Controller

G9SX-NSA222-T03-□

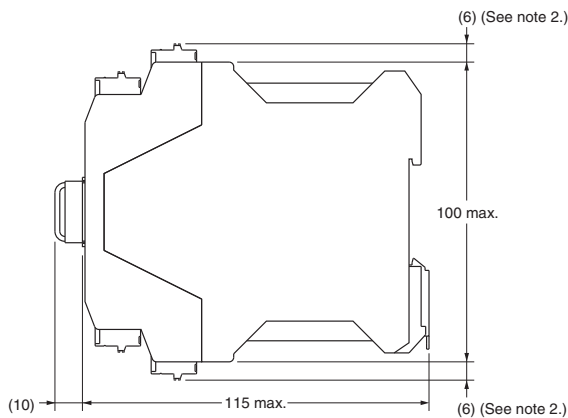
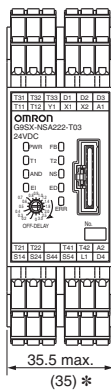
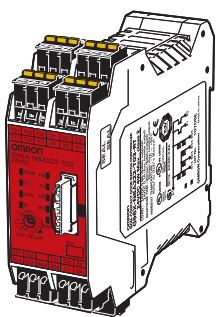

### Terminal arrangement

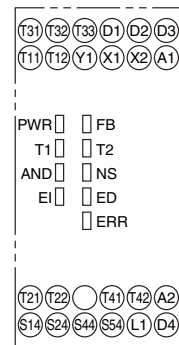

**Note: 1.** Above outline drawing is for models with spring-cage terminals (-RC).  
**2.** For models with spring-cage terminals (-RC) only.

\* Typical dimension

**Expansion Unit**

G9SX-EX401-□

Expansion Unit (OFF-delayed Model)

G9SX-EX041-T-□

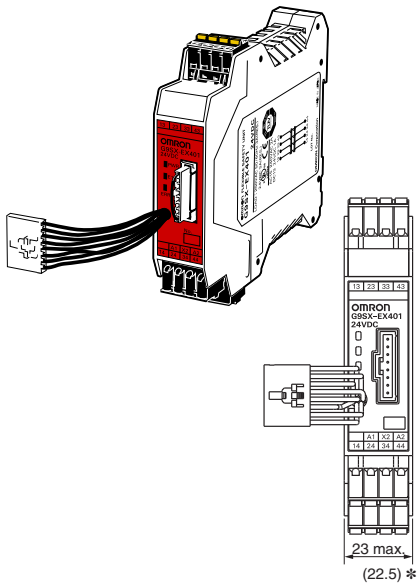

**Terminal arrangement**

G9SX-EX401-□ (Expansion Unit)      G9SX-EX041-T-□ (Expansion Unit with OFF Delay)

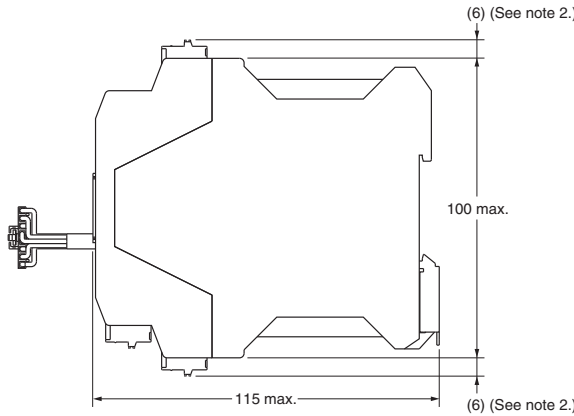
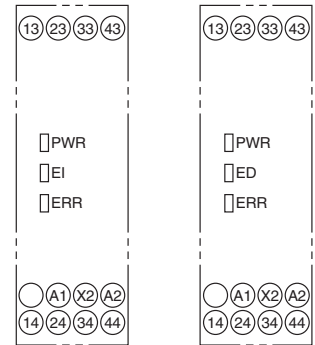

**Note:** 1. Above outline drawing is for models with spring-cage terminals (-RC).  
 2. For models with spring-cage terminals (-RC) only.  
 \* Typical dimension

For product information of G9SP, refer to the website at: <http://www.ia.omron.com/>

**Accessories (Sold separately)**

(Unit: mm)

**Socket on One Cable End (5-pole Connectors)**

- XS2F-D521-DG0-A (L=2m)
- XS2F-D521-GG0-A (L=5m)
- XS2F-D521-JG0-A (L=10m)
- XS2F-D521-KG0-A (L=15m)
- XS2F-D521-LG0-A (L=20m)

**Straight Connectors**

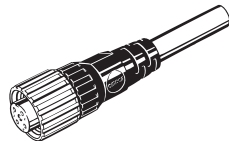
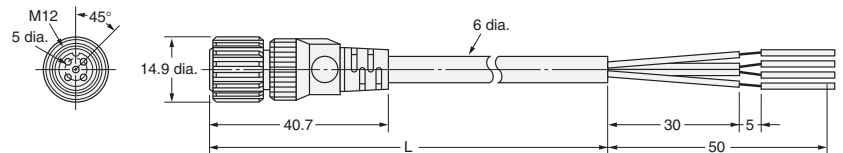

**Wiring Diagram**

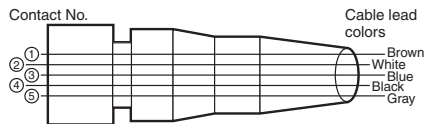

**Pin Arrangements (Engagement Side)**

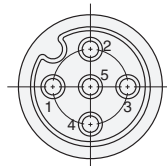

**Sockets and Plugs on Cable Ends (5-pole Connectors)**

- XS2W-D521-DG1-A (L=2m)
- XS2W-D521-GG1-A (L=5m)
- XS2W-D521-JG1-A (L=10m)
- XS2W-D521-KG1-A (L=15m)
- XS2W-D521-LG1-A (L=20m)

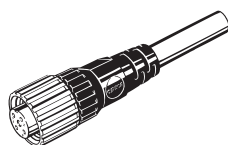

**Straight/Straight Connectors**

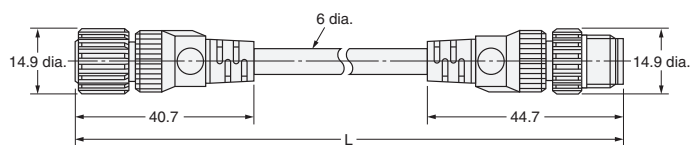

**Wiring Diagram for 5 Cores**

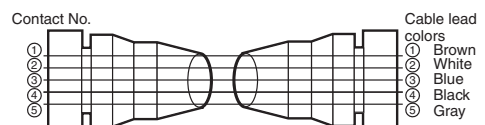

## Non-contact Door Switch D40A and Non-contact Door Switch Controller G9SX-NS □ Wiring

### Example: Wiring a Single Switch

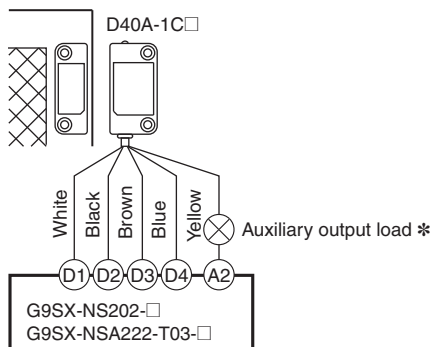

\* The auxiliary output load current must be 10 mA max.

### Example: Wiring Multiple Switches

Connect Up to 30 Non-contact Door Switches

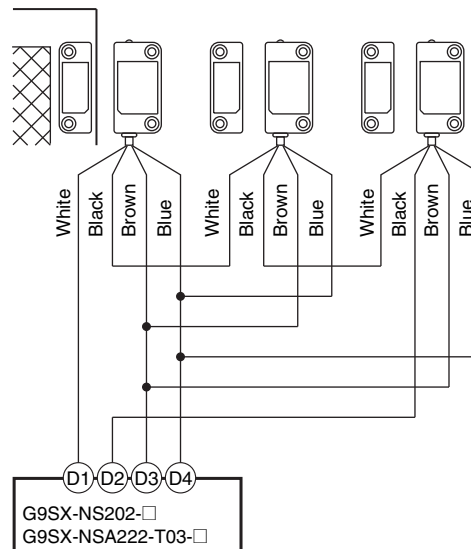

### Wiring of Inputs and Outputs

| Signal name                                | Wire color | Pin No. | Description of operation   |
|--|------------|---------|--|
| Non-contact Door Switch power supply input | Brown      | 1       | Supplies power to the D40A.  |
|  | Blue       | 3       | Connect to the D3 and D4 terminal of the G9SX-NS□.   |
| Non-contact Door Switch input              | White      | 2       | Inputs signals from the G9SX-NS□.<br>The Non-contact Door Switch input must be ON as a required condition for the Non-contact Door Switch output to be ON. |
| Non-contact Door Switch output             | Black      | 4       | Turns ON and OFF according to actuator detection and the status of the Non-contact Door Switch input.  |
| Auxiliary output                           | Yellow     | 5       | Turns ON when actuator is detected.  |

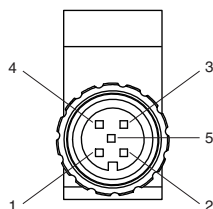



## Wiring of Inputs and Outputs

G9SX-NS202-□

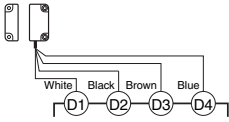
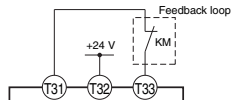
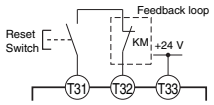
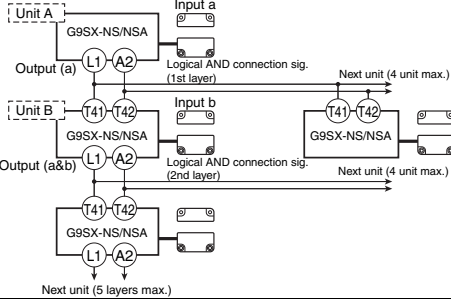
| Signal name                   | Terminal name  | Description of operation   | Wiring   |
|-------------------------------|----------------|--|--|
| Power supply input            | A1, A2         | Connect the power source to the A1 and A2 terminals.   | Connect the power supply plus (24 VDC) to the A1 terminal.<br>Connect the power supply minus (GND) to the A2 terminal. |
| Non-contact Door Switch input | D1, D2, D3, D4 | All Non-contact Door Switch inputs connected to the G9SX-NS□ must be ON as a required condition for the safety outputs to be ON. Otherwise the safety outputs cannot be in the ON state.   |                                     |
| Feedback/reset input          | T31, T32, T33  | To set the safety outputs in the ON state, the ON state signal must be input to T33. Otherwise the safety outputs cannot be in the ON state.   | Auto reset<br>                      |
|                               |                | To set the safety outputs in the ON state, the signal input to T32 must change from the OFF state to the ON state, and then to the OFF state. Otherwise the safety outputs cannot be in the ON state.  | Manual reset<br>                    |
| Logical AND connection input  | T41, T42       | A logical AND connection means that one unit (Unit A) outputs a safety signal "a" to a subsequent unit (Unit B) and Unit B calculates the logical AND (i.e., outputs the AND) of the signal "a" and safety signal "b", which is input to Unit B. Thereby the logic of the safety output of Unit B is (AND). (An AND of inputs "a" and "b" is output.)<br>To set the safety outputs of the subsequent Unit in the ON state, its logical AND connection preset switch must be set to AND (enable) and the high signal must be input to T41 of the subsequent unit. |                                     |
| Instantaneous safety output   | S14, S24       | Turns ON/OFF according to the state of the safety inputs, Non-contact Door Switch inputs, feedback/reset inputs, and logical AND connection inputs. During OFF-delay state, the Instantaneous safety outputs are not able to turn ON.  | Keep these outputs open when not used.   |
| Logical AND connection output | L1             | Outputs a signal of the same logic and at the same time as the instantaneous safety outputs.   | Keep these outputs open when not used.   |
| Auxiliary monitor output      | X1             | Outputs a signal of the same logic and at the same time as the instantaneous safety outputs.   | Keep these outputs open when not used.   |
| Auxiliary error output        | X2             | Outputs when the error indicator is lit or flashing.   | Keep these outputs open when not used.   |

G9SX-NSA222-T03-□

| Signal name                   | Terminal name  | Description of operation   | Wiring  |
|-------------------------------|----------------|--|---|
| Power supply input            | A1, A2         | Connect the power source to the A1 and A2 terminals.   | Connect the power supply plus (24 VDC) to the A1 terminal. Connect the power supply minus (GND) to the A2 terminal.                   |
| Safety input 1                | T11, T12       | To set the safety outputs in the ON state, the high state signals must be input to both safety input 1 and safety input 2. Otherwise the safety outputs cannot be in the ON state.   | Using safety input 1 system<br>   |
|                               |                |  | Using safety input 2 system (without short-circuit monitoring between systems)<br>  |
| Safety input 2                | T21, T22       |  | Using safety input 2 system (with short-circuit monitoring between systems)<br>   |
|                               |                |  |   |
| Non-contact Door Switch input | D1, D2, D3, D4 | All Non-contact Door Switch inputs connected to the G9SX-NS must be ON as a required condition for the safety outputs to be ON. Otherwise the safety outputs cannot be in the ON state.  |   |
| Feedback/reset input          | T31, T32, T33  | To set the safety outputs in the ON state, the ON state signal must be input to T33. Otherwise the safety outputs cannot be in the ON state.<br><br>To set the safety outputs in the ON state, the signal input to T32 must change from the OFF state to the ON state, and then to the OFF state. Otherwise the safety outputs cannot be in the ON state.  | Auto reset<br>  |
|                               |                |  | Manual reset<br>  |
| Logical AND connection input  | T41, T42       | A logical AND connection means that one unit (Unit A) outputs a safety signal "a" to a subsequent unit (Unit B) and Unit B calculates the logical AND (i.e., outputs the AND) of the signal "a" and safety signal "b", which is input to Unit B. Thereby the logic of the safety output "b" is output.)<br>To set the safety outputs of the subsequent Unit in the ON state, its logical AND connection preset switch must be set to AND (enable) and the high signal must be input to T41 of the subsequent unit. |   |
| Cross fault detection input   | Y1             | Selects the mode for the failure detecting (cross fault detecting) function for the safety inputs of G9SX corresponding to the connection of the cross fault detection input.  | Whether Y1 is connected depends on whether the T11 and T21 terminals are used. Refer to wiring information for safety inputs 1 and 2. |
| Instantaneous safety output   | S14, S24       | Turns ON/OFF according to the state of the safety inputs, feedback/reset inputs, and logical AND connection inputs. During OFF-delay state, the Instantaneous safety outputs are not able to turn ON.  | Keep these outputs open when not used.  |
| OFF-delayed safety output     | S44, S54       | OFF-delayed safety outputs. The OFF-delay time is set by the OFF-delay preset switch. When the delay time is set to zero, these outputs can be used as non-delay outputs.  | Keep these outputs open when not used.  |
| Logical AND connection output | L1             | Outputs a signal of the same logic and at the same time as the instantaneous safety outputs.   | Keep these outputs open when not used.  |
| Auxiliary monitor output      | X1             | Outputs a signal of the same logic and at the same time as the instantaneous safety outputs.   | Keep these outputs open when not used.  |
| Auxiliary error output        | X2             | Outputs when the error indicator is lit or flashing.   | Keep these outputs open when not used.  |

Connecting Safety Sensors

Safety sensors cannot be connected to safety inputs for the G9SX-NSA222-T03-□.

# Operation

## Functions

### Logical AND Connection

A logical AND connection means that the G9SX outputs a safety signal "a" to another G9SX, and that G9SX creates the logical AND of safety signal "a" and safety signal "b." The safety output of the G9SX-NSA222-T03-□ with the logical AND connection shown in the following diagram is "a" AND "b."

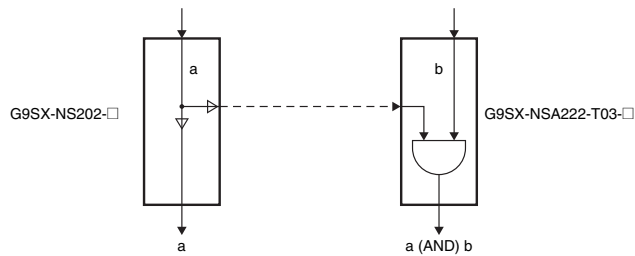

This is illustrated using the application in the following diagram as an example. The equipment here has two hazards identified as Robot 1 and Robot 2, and it is equipped with Non-contact Door Switches and an emergency stop button as safety measures. If the door to Robot 2 is opened, only Robot 2 is stopped (i.e., a partial stop). If the door to Robot 1 is opened or the emergency stop button is pressed, both Robot 1 and Robot 2 stop (i.e., a complete stop).

The actual situation using a G9SX for this application is shown in this example.

**Note:** The logical AND setting on the G9SX-NS202-□ must be set to AND (enabled).

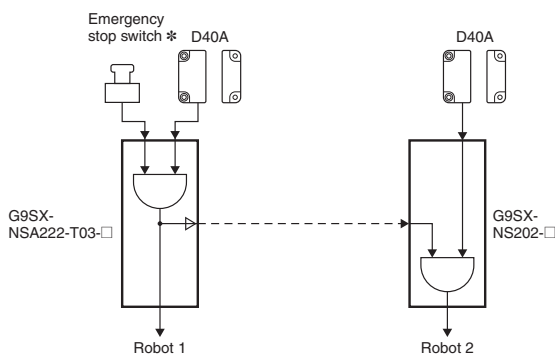
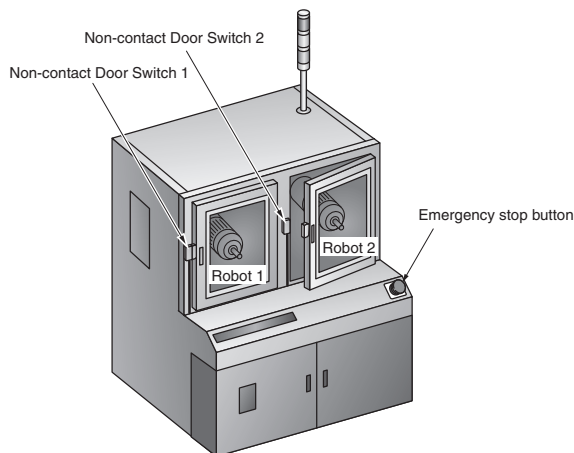

\* A manual reset is required when an emergency stop is used.

### Connecting Expansion Units

- The G9SX-EX and G9SX-EX-T Expansion Units can be connected to a G9SX-NSA222-T3-□ Non-contact Door Switch Controller to increase the number of safety outputs. (They cannot be connected to a G9SX-NS202-□.)
- A maximum of five Expansion Units can be connected to one G9SX-NSA222-T03-□. This may be a combination of G9SX-EX instantaneous models and G9SX-EX-T OFF-delayed models.
- Remove the terminating connector from the receptacle on G9SX-NSA222-T03-□ and insert the Expansion Unit cable connector into the receptacle. Insert the terminating connector into the receptacle on the Expansion Unit at the very end (rightmost).
- When Expansion Units are connected to a Controller, make sure that power is supplied to every Expansion Unit. (Refer to the following diagram for actual Expansion Unit connection.)

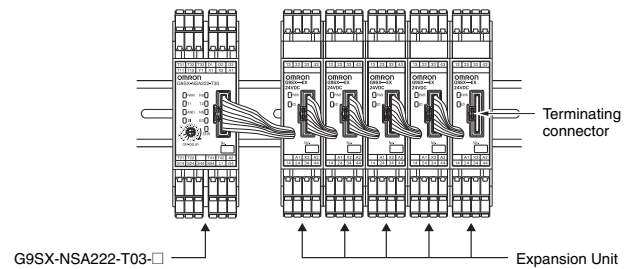

## Setting Procedure

### 1. Cross Fault Detection (G9SX-NSA222-T03-□)

Set the cross fault detection mode for safety inputs by shorting Y1 to 24 V or leaving it open.

When cross fault detection is set to ON, short-circuit failures are detected between safety inputs T11-T12 and T21-T22. When a cross fault is detected, the following will occur.

- (1) The safety outputs and logical AND outputs lock out.
- (2) The LED error indicator is lit.
- (3) The error output (auxiliary output) turns ON.

| Cross fault detection | Wiring                      |  |
|-----------------------|-----------------------------|--|
| OFF                   | Using safety input 1 system |  |
|                       | Using safety input 2 system |  |
| ON                    |                             |  |

### 2. Reset Mode (G9SX-NS202-□/NSA222-T03-□)

Set the reset mode using feedback/reset input terminals T31, T32, and T33.

Auto reset mode is selected when terminal T32 is shorted to 24 V and manual reset mode is selected when terminal T33 is shorted to 24 V.

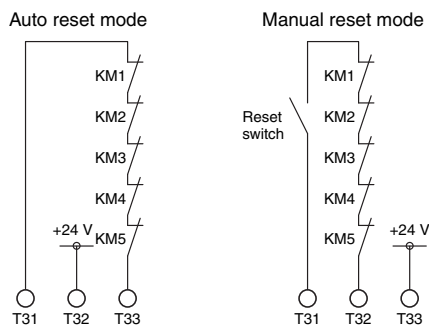

### 3. Setting Logical AND Connection (G9SX-NS202-□/NSA222-T03-□)

When connecting two or more Non-contact Door Switch Controllers by logical AND connection, set the logical AND connection preset switch on the Controller that is on the input side (Unit B in the following diagram) to AND. The default setting of the logical AND connection preset switch is set to OFF.

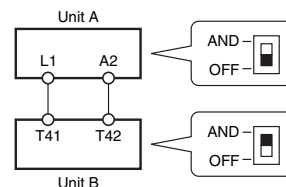

**Note:** A setting error will occur and Unit B will lock out if the logical AND setting switch on the Unit B is set to OFF.

### 4. Setting the OFF-delay Time (G9SX-NSA222-T03-□)

The OFF-delay preset time on G9SX-NSA222-T03-□ is set from the OFF-delay time preset switch (1 each on the front and back of the Unit).

Normal operation will only occur if both switches are identically set. An error will occur if the switches are not identically set. The default setting of the OFF-delay time preset switch is set to 0 s.

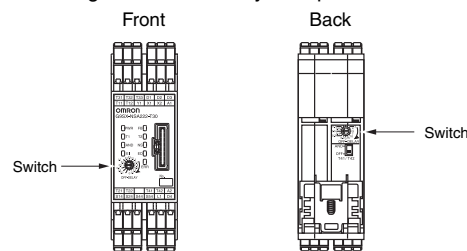

Refer to the following illustration for details on setting switch positions.

#### G9SX-NSA222-T03-□

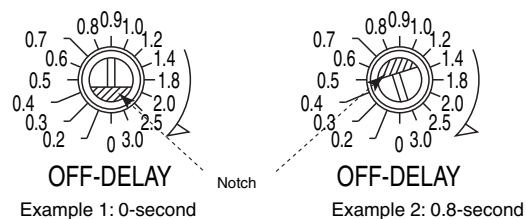

## LED Indicators

| Marking | Color  | Name                                    | G9SX-NS202 | G9SX-NSA222 | G9SX-EX | G9SX-EX-T | Function  | Reference |
|---------|--------|---|------------|-------------|---------|-----------|---|-----------|
| PWR     | Green  | Power supply indicator                  | ○          | ○           | ○       | ○         | Lights while power is supplied.   | ---       |
| T1      | Orange | Safety input #1 indicator               | ---        | ○           | ---     | ---       | Lights while a high signal is input to T12. Flashes when an error relating to safety input #1 occurs.   | *         |
| T2      | Orange | Safety input #2 indicator               | ---        | ○           | ---     | ---       | Lights while a high signal is input to T22. Flashes when an error relating to safety input #2 occurs.   |           |
| NS      | Orange | Non-contact Door Switch input indicator | ○          | ○           | ---     | ---       | Lights when the Non-contact Door Switch input turns ON. Flashes when an error relating to the Non-contact Door Switch input occurs.   |           |
| FB      | Orange | Feedback/reset input indicator          | ○          | ○           | ---     | ---       | Lights in the following cases:<br>With automatic reset while a high signal is input to T33.<br>With manual reset while a high signal is input to T32.<br>Flashes when an error relating to feedback/reset input occurs. |           |
| AND     | Orange | Logical AND input indicator             | ○          | ○           | ---     | ---       | Lights while a high signal is input to T41. Flashes when an error relating to logical AND connection input occurs.  |           |
| EI      | Orange | Instantaneous safety output indicator   | ○          | ○           | ○       | ---       | Lights while the Instantaneous safety outputs (S14, S24, S34) are in the ON state. Flashes when an error relating to the instantaneous safety output occurs.  |           |
| ED      | Orange | OFF-delayed safety output indicator     | ---        | ○           | ---     | ○         | Lights while OFF-delayed safety outputs (S44, S54) are in the ON-state. Flashes when an error relating to OFF-delayed safety output occurs.   |           |
| ERR     | Red    | Error indicator                         | ○          | ○           | ○       | ○         | Lights or flashes when an error occurs.   |           |

\* Refer to "Fault Detection" on the next page for details.

## Settings Indication (at Power ON)

Settings for the G9SX can be checked by the orange indicators for approx. 3 seconds after the power is turned ON. During this settings indication period, the ERR indicator will light, however the auxiliary error output will remain OFF.









| Indicator | Item                              | Setting position                     | Indicator status | Setting mode              | Setting status |
|-----------|-----------------------------------|--------------------------------------|------------------|---------------------------|----------------|
| T1        | Cross fault detection mode        | Y1 terminal                          | Lit              | Detection mode            | Y1 = open      |
|           |                                   |                                      | Not lit          | Non-detection mode        | Y1 = 24 VDC    |
| FB        | Reset mode                        | T32 or T33 terminal                  | Lit              | Manual reset mode         | T33 = 24 VDC   |
|           |                                   |                                      | Not lit          | Auto reset mode           | T32 = 24 VDC   |
| AND       | Logical AND connection input mode | Logical AND connection preset switch | Lit              | Enable logical AND input  | AND            |
|           |                                   |                                      | Not lit          | Disable logical AND input | OFF            |

## Fault Detection

When the Non-contact Door Switch Controller detects a fault, the ERR indicator and/or other indicators light up or flash to inform the user about the fault.

Check and take necessary measures referring to the following table, and then re-supply power to the Non-contact Door Switch Controller.

(G9SX-NS202-□/NSA222-T03-□)

| ERR indicator   | Other indicator   | Fault  | Expected causes of the fault  | Check points and measures to take  |
|---|---|--|---|--|
| <br>Flashes      | ---   | Fault due to electromagnetic disturbance or of internal circuits.  | <ol style="list-style-type: none"> <li>Excessive electromagnetic disturbance</li> <li>Failure of the internal circuit</li> </ol>  | <ol style="list-style-type: none"> <li>Check the disturbance level around the G9SX and the related system.</li> <li>Replace with a new product.</li> </ol>   |
| <br>Lights     | <br>T1 flashes   | Fault involved with safety input 1   | <ol style="list-style-type: none"> <li>Error in the wiring of safety input 1</li> <li>Incorrect setting of cross fault detection input</li> <li>Failure of the circuit of safety input 1</li> </ol>   | <ol style="list-style-type: none"> <li>Check the wiring to T11 and T12.</li> <li>Check the wiring to Y1.</li> <li>Replace with a new product.</li> </ol>   |
|   | <br>T2 flashes   | Fault involved with safety input 2   | <ol style="list-style-type: none"> <li>Error in the wiring of safety input 2</li> <li>Incorrect setting of cross fault detection input</li> <li>Failure of the circuit of safety input 2</li> </ol>   | <ol style="list-style-type: none"> <li>Check the wiring to T21 and T22.</li> <li>Check the wiring to Y1.</li> <li>Replace with a new product.</li> </ol>   |
|   | <br>NS flashes   | Fault involved with Non-contact Door Switch input  | <ol style="list-style-type: none"> <li>Error in the wiring of Non-contact Door Switch input</li> <li>Error in the wiring of Non-contact Door Switch inputs in series connections.</li> <li>Failure of the internal circuits of Non-contact Door Switch inputs</li> <li>Failure of the Non-contact Door Switch</li> </ol>  | <ol style="list-style-type: none"> <li>Check the wiring to D1 and D2.</li> <li>Check the wiring to the D40A.</li> <li>Replace with a new product.</li> <li>Replace with a new D40A.</li> </ol>   |
|   | <br>FB flashes | Fault involved with feedback/reset inputs  | <ol style="list-style-type: none"> <li>Error in the wiring of feedback/reset input.</li> <li>Failure of the circuit of feedback/reset input</li> </ol>  | <ol style="list-style-type: none"> <li>Check the wiring to T31, T32 and T33.</li> <li>Replace with a new product.</li> </ol>   |
|   |   | Fault in Expansion Unit  | <ol style="list-style-type: none"> <li>Improper feedback signals from Expansion Unit</li> <li>Abnormal supply voltage to Expansion Unit</li> <li>Failure of the circuit of safety relay contact outputs</li> </ol>  | <ol style="list-style-type: none"> <li>Check the connecting cable of Expansion Unit and the connection of the termination socket.</li> <li>Check the supply voltage to Expansion Unit.</li> <li>Replace with a new product.</li> </ol> <p><b>Note:</b> Make sure that all Expansion Units' PWR indicators are lit.</p> |
|   | <br>EI flashes | Fault involved with instantaneous safety outputs, logical AND connection outputs, or auxiliary monitor output  | <ol style="list-style-type: none"> <li>Error in the wiring of instantaneous safety outputs</li> <li>Failure of the circuit of instantaneous safety outputs</li> <li>Error in the wiring of the logical AND connection output</li> <li>Failure of the circuit of the logical AND connection output</li> <li>Error in the wiring of the auxiliary monitor output</li> <li>Impermissible high ambient temperature</li> </ol> | <ol style="list-style-type: none"> <li>Check the wiring to S14 and S24.</li> <li>Replace with a new product.</li> <li>Check the wiring to L1.</li> <li>Replace with a new product.</li> <li>Check the wiring to X1.</li> <li>Check the ambient temperature and spacing around the G9SX.</li> </ol>                     |
| <br>ED flashes | Fault involved with OFF-delayed safety outputs  | <ol style="list-style-type: none"> <li>Error in the wiring of OFF-delayed safety relay contact outputs</li> <li>Incorrect set values for OFF-delay time</li> <li>Failure of the circuit of OFF-delayed safety relay contact outputs</li> <li>Impermissible high ambient temperature</li> </ol> | <ol style="list-style-type: none"> <li>Check the wiring to S44 and S54.</li> <li>Check the settings of the OFF-delay time setting switch.</li> <li>Replace with a new product.</li> <li>Check the ambient temperature and spacing around the G9SX.</li> </ol>   |  |

| ERR indicator | Other indicator                      | Fault  | Expected causes of the fault   | Check points and measures to take  |
|---------------|--------------------------------------|--|--|--|
| ●<br>Lights   | ☀<br>AND flashes                     | Fault involved with logical AND connection input | 1. Error in the wiring of the logical AND connection input<br><br>2. Incorrect setting for the logical AND connection input<br>3. Failure of the circuit of the logical AND connection input | 1. Check the wiring to T41 and T42.<br><b>Note:</b> 1. Make sure that the wiring length for the T41, T42 terminal is 100 meters or less.<br>2. Make sure that the logical AND connection signal is branched for 4 units or fewer.<br><br>2. Confirm the set value of the logical AND connection preset switch.<br>3. Replace with a new product. |
|               | ☀<br>All indicators except PWR flash | Supply voltage outside the rated value           | 1. Supply voltage outside the rated value  | 1. Check the supply voltage to the Units.  |

When indicators other than the ERR indicator flash, check and take necessary actions referring to the following table.

| ERR indicator | Other indicators       | Fault                                 | Expected cause of the fault   | Check points and measures to take  |
|---------------|------------------------|---------------------------------------|---|--|
| ○<br>Off      | T1<br>T2<br>☀<br>flash | Mismatch between input 1 and input 2. | The input status between input 1 and input 2 is different, due to contact failure or a short circuit of safety input device(s) or a wiring fault. | Check the wiring from safety input devices to the G9SX. Or check the input sequence of safety input devices. After removing the fault, turn both safety inputs 1 and 2 to the OFF state. |

#### (Expansion Unit)

| ERR indicator | Other indicators | Fault   | Expected cause of the fault  | Check points and measures to take |
|---------------|------------------|---|--|-----------------------------------|
| ●<br>Lights   | ---              | Fault involved with safety relay outputs of Expansion Units | 1. Welding of relay contacts<br>2. Failure of the internal circuit | Replace with a new product.       |





| PL/safety category | Model   | Stop category | Reset |
|--------------------|---|---------------|-------|
| PLe/3 equivalent   | Non-contact Door Switch D40A<br>Non-contact Door Switch Controller G9SX-NSA222-T03-□ (24 VDC) | 1             | Auto  |

- Note:**
- The above PL is only the evaluation result of the example. The PL must be evaluated in an actual application by the customer after confirming the usage conditions.
  - The above PL is the evaluation result concerning the guard 2. The PL for guard 1 and other safety functions must be separately evaluated.
  - Stopping time is required between when an opening of the guard 2 is detected and when the motor M stops. Use after risk assessment to prevent operators from approaching hazardous areas too closely during this period.

**● Application Overview**

- The S3 monitors the guard 2, and stop command is sent to the motor controller when the guard 2 is opened.
- The power supply to the motor M1 is turned OFF after OFF-delay time.
- The power supply to the motor M1 is kept OFF while the guard 2 is opened.
- The power supply to the motor M1 is turned ON again when the guard 2 is closed.

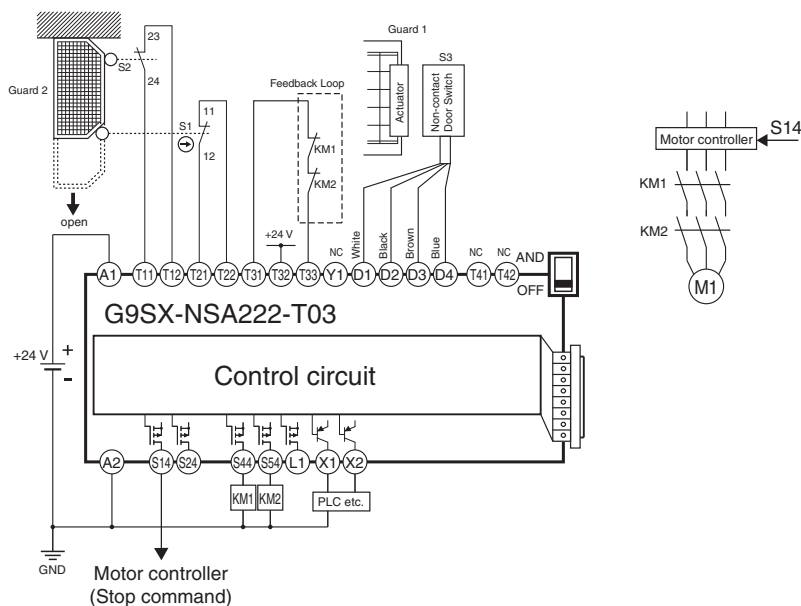

- S1: Safety limit switch
- S2: Limit switch
- S3: Non-contact Door Switch
- KM1, KM2: Contactor
- M1: 3-phase motor

**Note:** For details on Non-contact Door Switch wiring, refer to pages 17 and 18 or to the User's Manual.

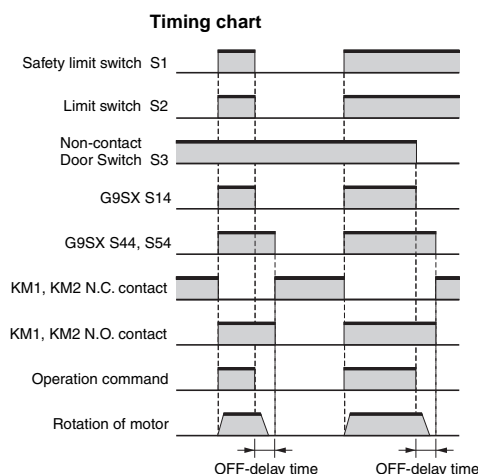

| PL/safety category | Model  | Stop category | Reset |
|--------------------|--|---------------|-------|
| PLe/3 equivalent   | Non-contact Door Switch D40A<br>Non-contact Door Switch Controller G9SX-NS202-□ (24 VDC) | 0             | Auto  |

**Note: 1.** The above PL is only the evaluation result of the example. The PL must be evaluated in an actual application by the customer after confirming the usage conditions.

**2.** The above PL is the evaluation result concerning the guard. The PL for emergency stop switch and other safety functions must be separately evaluated.

● **Application Overview**

- The S3 monitors the guard, and the power supply to the motor M2 is turned OFF immediately when the guard is opened.
- The power supply to the motor M2 is kept OFF while the guard is opened.
- The power supply to the motor M2 is turned ON again when the guard is closed.

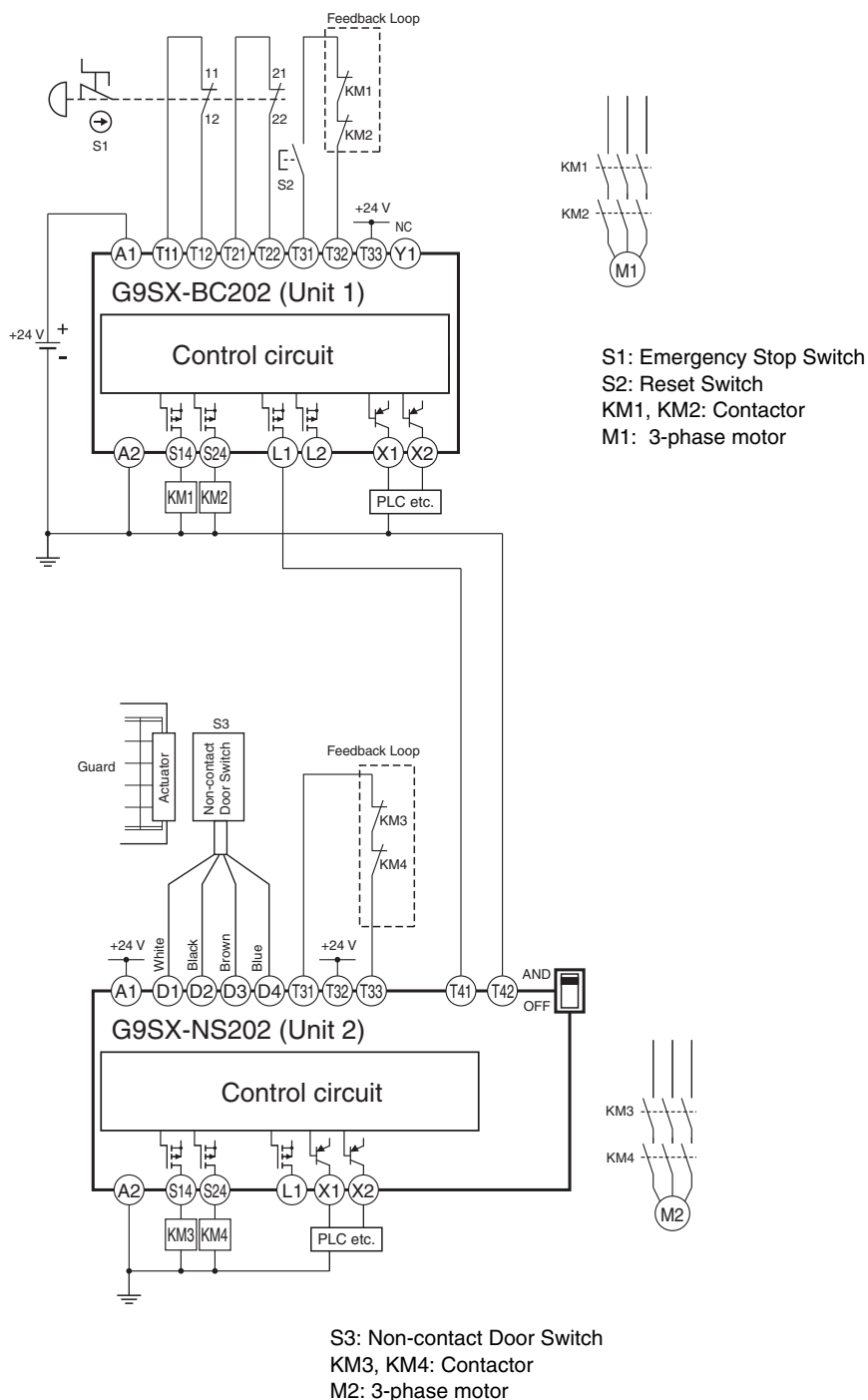

**Timing chart**

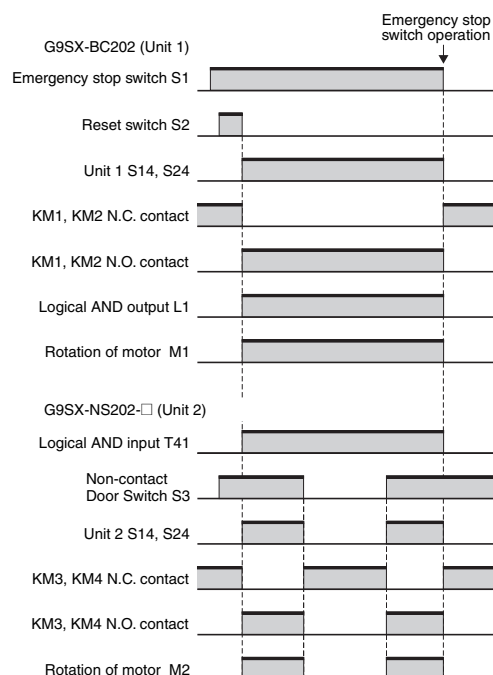

**Note:** For details on Non-contact Door Switch wiring, refer to pages 17 and 18 or to the User's Manual.









## Safety Precautions

Refer to the “*Precautions for All Switches*” and “*Precautions for All Safety Door Switches*”.

### Indication and Meaning for Safe Use

|  |  |
|--|--|
|  <b>WARNING</b> | Indicates a potentially hazardous situation which, if not avoided, will result in minor or moderate injury, or may result in serious injury or death. Additionally there may be significant property damage. |
| <b>Precautions for Safe Use</b>  | Supplementary comments on what to do or avoid doing, to use the product safely.  |
| <b>Precautions for Correct Use</b>   | Supplementary comments on what to do or avoid doing, to prevent failure to operate, or undesirable effect on product performance.  |

|   |   |
|---|---|
|  <b>WARNING</b>  |   |
| <p>Serious injury may possibly occur due to breakdown of safety outputs.<br/>Do not connect loads beyond the rated value to the safety outputs.</p>   |    |
| <p>Serious injury may possibly occur due to loss of required safety functions.<br/>Wire the D40A and G9SX-NS properly so that supply voltages or voltages for loads do NOT touch the safety outputs accidentally.</p> |    |
| <p>Serious injury may possibly occur due to damage to safety outputs.<br/>Provide protective circuits against counter-electromotive force if inductive loads are connected to safety outputs.</p>                     |   |
| <p>Serious injury may possibly occur due to loss of safety functions.<br/>Use appropriate devices referring to the information provided below.</p>  |  |
| <p>The machine may start operating and may result in serious injury or death.<br/>Do not put the actuator close to the switch when the door is open.</p>  |  |

| Control device                          | Requirements  |
|---|---|
| Emergency stop switch                   | Use approved device with direct opening mechanism complying with IEC/EN 60947-5-1.  |
| Safety door switch, Safety limit switch | Use approved device with direct opening mechanism complying with IEC/EN 60947-5-1 and capable of switching micro loads of 24 VDC, 5 mA.   |
| Non-contact Door Switch                 | The G9SX-NS must be used with D40A Non-contact Door Switches.   |
| Relay with forcibly guided contacts     | Use approved devices with forcibly guided contacts complying with EN 50205.<br>For feedback, use devices with contacts capable of switching micro loads of 24 VDC, 5 mA.  |
| Contactor                               | Use contactors with forcibly guided mechanism to input the signal to the Feedback/Reset input of the G9SX-NS through the NC contact of the contactor.<br>For feedback, use devices with contacts capable of switching micro loads of 24 VDC, 5 mA.<br>Failure to open contacts of a contactor cannot be detected by connecting NC contact of the contactor without a forcibly guided mechanism to the Feedback/Reset input. |
| Other devices                           | Evaluate whether devices used are appropriate to satisfy the requirements of the safety category level.   |

### Precautions for Safe Use

- <D40A/G9SX-NS□>
- Disconnect the G9SX-NS from the power supply when wiring the D40A.
    - Turn OFF the load power supply before wiring. Failure to do so may cause electric shock.
    - Devices connected to the product may operate unexpectedly.
  - Do not operate the product in atmospheres containing flammable or explosive gas. Arcs or heating of relays during switching may cause fire or explosion.
  - Wire conductors correctly and verify the operation of the product before using the system in which the product is incorporated. Incorrect wiring may lead to loss of safety functions.
  - Do not dismantle, repair, or modify the product. Doing so may lead to loss of safety functions.
- <D40A>
- Auxiliary monitoring outputs are NOT safety outputs. Do not use auxiliary monitoring outputs as safety outputs. Such incorrect use will cause loss of safety function of D40A and peripheral devices.
  - After installing the D40A, qualified personnel must confirm the installation, and must conduct test operations and maintenance. The qualified personnel must be qualified and authorized to secure safety at each phases of design, installation, running, maintenance, and disposal of the system.
  - A qualified person in charge, who is familiar with the machine in which the D40A is to be installed, must conduct and verify the installation.
  - Be sure to inspect the D40A daily and every 6 months. Otherwise, serious injury may possibly occur due to system malfunctions.
  - Connect the D40A to only appropriate components or devices complying with relevant safety standards corresponding to the required level of safety category. Conformity to requirements of the safety category must be determined for the entire system. It is recommended to consult an authorized certification body regarding assessment of conformity to the required safety level.
- <G9SX-NS□>
- Use the G9SX within an enclosure with a IP54 degree of protection or higher according to IEC/EN 60529.
  - Do not apply DC voltages exceeding the rated voltages, nor any AC voltages to G9SX-NS□.
  - Use a DC supply satisfying the requirements given below to prevent electric shock.
    - A DC power supply with double or reinforced insulation, for example, according to IEC/EN 60950 or EN 50178, or a transformer according to IEC/EN 61558.
    - A DC supply satisfying the requirements for class 2 circuits or limited voltage/current circuits stated in UL 508.
  - Properly apply the specified voltages to the inputs. Applying inappropriate voltages may cause the product to fail to perform its specified function, which could lead to the loss of safety functions or damages to the product.
  - Auxiliary error outputs and auxiliary monitoring outputs are NOT safety outputs. Do not use these outputs as safety outputs. Such incorrect use will cause loss of safety functions of the G9SX and its relevant system. Also logical AND connection outputs can only be used for logical AND connections with the G9SX-□.
  - After installing the G9SX-NS□, qualified personnel must confirm the installation, and must conduct test operations and maintenance. The qualified personnel must be qualified and authorized to secure safety at each phases of design, installation, running, maintenance, and disposal of system.
  - A qualified person in charge, who is familiar with the machine in which G9SX-NS□ is to be installed, must conduct and verify the installation.
  - Perform daily and 6-month inspections for the G9SX-NS□. Otherwise, the system may fail to work properly, resulting in serious injury.

18. Connect to the G9SX-NS□ only appropriate components or devices complying with relevant safety standards corresponding to the required level of safety category.  
Conformity to requirements of safety category must be determined as an entire system. It is recommended to consult an authorized certification body regarding assessment of conformity to the required safety level.
19. OMRON is not responsible for conformity with any safety standards covering the customer's entire system.
20. Be careful not to have your fingers caught when mounting terminal blocks.
21. The service life will depend on the switching conditions. Be sure to check the actual operating conditions using the actual devices, and make sure that the number of switching operations will not cause performance problems.

## Precautions for Correct Use

<D40A/G9SX-NS□>

1. Handle with Care.  
Do not drop the product or expose it to excessive vibration or mechanical shock. The product may be damaged and may not function properly.
2. Storage and Operating Conditions  
Do not store or use the products under the following conditions.
  1. In direct sunlight
  2. At ambient temperatures not between -10 and 55°C
  3. At relative humidity not between 25% and 85% or under temperature changes that could causes condensation
  4. In corrosive or combustible gases
  5. Where subject to vibration or mechanical shock beyond the rated values
  6. Where subject to contact with water, oil, or chemicals
  7. In an atmosphere containing excessive dust, saline, or metal powder
  8. Where iron filings or powder may fall on the product
3. D40A is a class A product. In residential areas D40A may cause radio interference, in which case the user may be required to take adequate measures to reduce interference.

<D40A>

4. Always use the D40A/G9SX-NS together with the special actuator and a G9X-NS□ Controller. If you use any other OMRON Safety Controller, confirm applicability in the manual for the Safety Controller.
5. Use cables with a length of less than 100 m total to connect D40A Switches. The supply voltage to D40A may decrease by the voltage drop depending on the cable or the wiring configuration. Check the power-supply voltage is in the rated range.

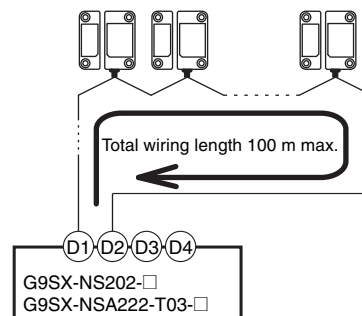

6. Disconnect the G9SX-NS□ from the power supply when replacing the D40A. Devices connected to the G9SX-NS□ may operate unexpectedly.
7. Adhesion of solvent such as alcohol, thinner, trichlorobenzene or gasoline on the product should be avoided.  
Such solvents make the marking on D40A illegible and cause deterioration of parts.
8. Do not use the D40A in a magnetic field of 1.5 mT or higher. The D40A may not function properly.
9. Do not use the D40A in the water or in an environment continuously exposed to water. Water may penetrate into the D40A. (The IP67 degree of protection for this switch means that it has been checked for penetration of water after having been left in water for a fixed period of time.)
10. Do not use the switch or actuator as a stopper. Protect the switch and the actuator by installing a stopper. Separate the switch and the actuator to a distance of 1 mm or more.
11. Install the actuator and switch at an appropriate distance so that they do not create a gap that provides access to the hazard.

**Correct**

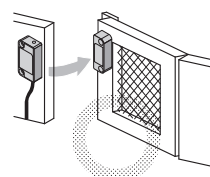

**Incorrect**

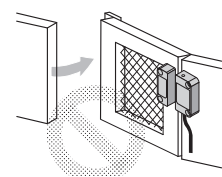

12. Where two or more Switches are mounted side-by-side, they must be no closer than 25 mm.

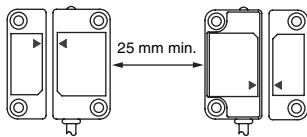

13. Check that the machine is stopped whenever the interlocked guard door is open.

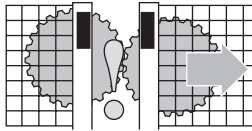

14. Do not mount the switch and actuator on magnetic materials, otherwise it may affect the operating distance.

| Distance from surface of magnetic body | Operating distance                       |
|--|--|
| 0 to 5 mm                              | Reduce to approx. 90% of original value. |
| 5 mm or longer                         | No influence.                            |

15. Tighten all screws to the specified torque by using non-magnetic M4 screws with a maximum diameter of 7 mm and washer for the installation of the switch and actuator. After installation and using, the actuator and switch fixing screws must be coated with tamper proof varnish or similar compound. Using anaerobic locking compounds can have a detrimental effect on the plastic switch case if the compounds come into contact with the switch case.

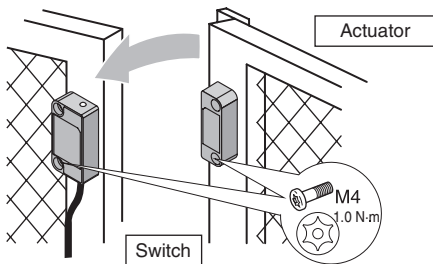

## 16. Wiring

- Use the following to wire to the product.  
Stranded wire (flexible wire): 0.2 to 2.5 mm<sup>2</sup> (AWG24 to AWG12)  
Solid wire (steel wire): 0.2 to 2.5 mm<sup>2</sup> (AWG24 to AWG12)
  - When an auxiliary output is not used, cut off the wiring and cover it with tape so that it does not contact other terminals.
  - When you use an additional cable of 20m or longer, use a multiconductor cable to group the white, black, brown, and blue lines together.
17. Handle cables with care
- For bending cables, it is recommended to bend them with a radius of bend no less than six times the cable outer diameter.
  - Do not apply a tensile strength of 50N or greater to the cables.
18. If there is any machine that has a large surge current (e.g., amotor) near D40A, connect a surge absorber to D40A between the blue and the other cables (white, black, brown, and yellow), respectively.

Suggested surge absorber's specification is as follows:

- Peak pulse power: 600W (10/1000 ms) or more (Per IEC61000-4-5(surge immunity))
- Breakdown voltage: 27-33V

## <G9SX-NS□>

### 19. Mounting

Mount the G9SX-NS to a DIN rail using End Plates (PFP-M, not included with the product) so that the G9SX-NS does not fall off of the rails due to vibration or other causes, especially when the length of DIN railing is short compared to the width of the G9SX-NS□.

20. The following space must be provided around the G9SX-NS□ to enable applying the rated current to the outputs of the G9SX-NS□, to ensure sufficient ventilation, and to enable wiring:
- At least 25 mm between side surfaces of the G9SX-NS□
  - At least 50 mm above the top surface of the G9SX-NS□ and below the bottom surface of the G9SX-NS□.

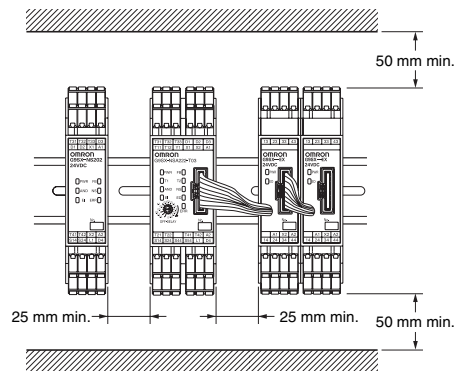

### 21. Wiring

#### 1. G9SX-NS□-RT (with Screw Terminals)

- Use the following to wire the G9SX-NS□-RT.

|                                      |   |
|--------------------------------------|---|
| <b>Solid wire (steel wire)</b>       | 0.2 to 2.5 mm <sup>2</sup> (AWG24 to AWG12) |
| <b>Stranded wire (flexible wire)</b> | 0.2 to 2.5 mm <sup>2</sup> (AWG24 to AWG12) |

- Tighten each screw to the specified torque of 0.5 to 0.6 N·m, or the G9SX-NS□ may malfunction or generate heat.
- Strip the wire for no longer than 7 mm.

#### 2. G9SX-NS□-RC (with Spring-cage Terminals)

- Use the following to wire the G9SX-NS□-RC.

|                                      |   |
|--------------------------------------|---|
| <b>Solid wire (steel wire)</b>       | 0.2 to 2.5 mm <sup>2</sup> (AWG24 to AWG12) |
| <b>Stranded wire (flexible wire)</b> | 0.2 to 2.5 mm <sup>2</sup> (AWG24 to AWG12) |

- Strip the wire for no longer than 7 mm.

#### 3. Logical AND Connections

- Use VCTF cables or shielded cables for logical AND connections between Units.

### 22. Connecting G9SX-EX□-□ Expansion Units

- Remove the terminating connector from the connector on the G9SX-NSA222-T03□. Insert the connector on the connecting cable of Expansion Unit into the connector on the G9SX-NSA222-T03□.
- Connect the terminating connector to the connector on the Expansion Unit at the end position.  
When the G9SX-NSA222-T03□ is used without Expansion Units, leave the terminating connector on the G9SX-NSA222-T03□.
- Do not remove the terminating connector or connecting cables of Expansion Units while the system is operating.
- Before applying the supply voltage, confirm that the connectors are locked firmly.
- All of the Expansion Units must be supplied with its specified voltages within 10 s after the connected G9SX-NSA222-T03□ is supplied with voltage.  
Otherwise, the G9SX-NSA222-T03□ will detect a power supply error for the Expansion Units.

23. Use cables with a length of less than 100 m total to connect the safety inputs, feedback/reset inputs, and logical AND connection inputs and outputs.

24. Set the time duration of OFF-delay to an appropriate value that does not cause the loss of safety functions of system.
25. Logical AND connections between Units (Refer to "Functions" on page 19.)
- To use logical AND connection inputs, enable the logical AND connection input for the G9SX-NS□ that will receive the inputs.
  - Connect the logical AND connection inputs appropriately to the logical AND connection outputs of the G9SX-□.
  - When configuring the safety system, be sure to consider that the delay of response time caused by logical AND connection does not degrade the safety functions of the system. (Refer to "Response Time and Operating Time" on page 12.)
26. To determine safety distance to hazards, take into account the delay of safety outputs caused by the following time:
- Response time of safety inputs
  - Response time of D40A Non-contact Door Switch inputs
  - Response time of logical AND connection input  
(Refer to "Response Time and Operating Time" on page 12.)
  - Preset OFF-delay time
  - Accuracy of OFF-delay time
27. Start the rest of the system after 5 s or longer has passed since applying supply voltage to all G9SX-□ in the system.
28. Be sure to ground the A2 terminal of the power supply to help prevent malfunctions caused by noise. Also, connect a surge absorber to each end of the coil on inductive loads to reduce noise generation. When sharing a power supply with a Light Curtain, use a DC power supply that will not fail for a momentary power interruption of 20 ms or less.
29. Devices connected to the G9SX-NS may operate unexpectedly. When replacing the G9SX-NS, disconnect it from power supply.
30. Adhesion of solvent  
Do not allow organic solvents, such as alcohol, thinner, trichloroethane, or gasoline, to come into contact with the product. Such solvents make the markings on G9SX-NS illegible and cause deterioration of parts.
31. Do not mix AC and DC circuits for contact outputs in a single G9SX-EX□-□. When using AC and DC circuits, connect at least two G9SX-EX□-□ Units and use them respectively as dedicated DC-circuit and AC-circuit contact outputs.
32. Safety Application Controller's Relay durability depends greatly on the switching condition. Confirm the actual conditions of operation in which the Relay will be used in order to make sure the permissible number of switching operations.  
When the accumulated number of operation exceeds its permissible range, it can cause failure of reset of safety control circuit. In such case, please replace the Relay or the Safety Application Controller immediately.  
If the Relay or the Safety Application Controller is used continuously without replacing, then it can lead to loss of safety function.

## Switch and Actuator Operation

### Switch and Actuator Mounting Directions

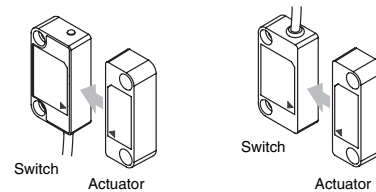

### Switch and Actuator Operating Directions

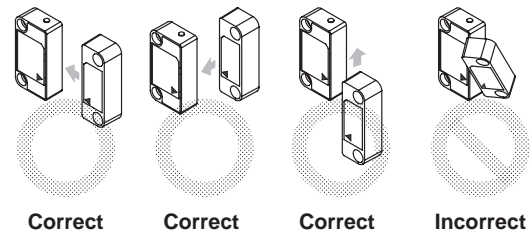

## Safety Categories

You can use the D40A with the G9SX-NS□ for applications in PLd and Safety Category 3 environments defined in the EN ISO13849-1 European standard and the ISO 13849-1 international standard. Compliance was determined using circuit examples specified by OMRON and may not be applicable to all conditions. Safety categories are determined for the overall safety control system. Confirm compliance sufficiently with your application.

### Requirements for Safety Category 3 (ISO 13849-1)

- Connect external input D1-D2 and external output D3-D4 to D40A Switches.
- Input two channels for external inputs T11-T12 and T21-T22.
- Input external inputs T11-T12 and T21-T22 from switches with direct opening mechanisms. For limit switches, make sure at least one of the switches has a direct opening mechanism.
- Input the NC signal from the contactor to T31-T32 for a manual reset and to T31-T33 for an auto reset. (Refer to "Application Examples" on page 24)
- Make sure to connect the A2 terminal to ground.

## Approved Standards

<D40A>

- EN ISO 13849-1 PLd/Safety Category 3 (used with G9SX-NS□)
- EN 61508 SIL 3 (used with G9SX-NS□)
- EN 60947-5-3 (PDF-M) (used with G9SX-NS□)
- EN1088
- UL 508
- CAN/CSA C22.2 No.14
- KOSHA certification (excluding connector model)

**ALL DIMENSIONS SHOWN ARE IN MILLIMETERS.**

To convert millimeters into inches, multiply by 0.03937. To convert grams into ounces, multiply by 0.03527.

# Terms and Conditions of Sale

1. **Offer; Acceptance.** These terms and conditions (these "**Terms**") are deemed part of all quotes, agreements, purchase orders, acknowledgments, price lists, catalogs, manuals, brochures and other documents, whether electronic or in writing, relating to the sale of products or services (collectively, the "**Products**") by Omron Electronics LLC and its subsidiary companies ("**Omron**"). Omron objects to any terms or conditions proposed in Buyer's purchase order or other documents which are inconsistent with, or in addition to, these Terms.
2. **Prices; Payment Terms.** All prices stated are current, subject to change without notice by Omron. Omron reserves the right to increase or decrease prices on any unshipped portions of outstanding orders. Payments for Products are due net 30 days unless otherwise stated in the invoice.
3. **Discounts.** Cash discounts, if any, will apply only on the net amount of invoices sent to Buyer after deducting transportation charges, taxes and duties, and will be allowed only if (i) the invoice is paid according to Omron's payment terms and (ii) Buyer has no past due amounts.
4. **Interest.** Omron, at its option, may charge Buyer 1-1/2% interest per month or the maximum legal rate, whichever is less, on any balance not paid within the stated terms.
5. **Orders.** Omron will accept no order less than \$200 net billing.
6. **Governmental Approvals.** Buyer shall be responsible for, and shall bear all costs involved in, obtaining any government approvals required for the importation or sale of the Products.
7. **Taxes.** All taxes, duties and other governmental charges (other than general real property and income taxes), including any interest or penalties thereon, imposed directly or indirectly on Omron or required to be collected directly or indirectly by Omron for the manufacture, production, sale, delivery, importation, consumption or use of the Products sold hereunder (including customs duties and sales, excise, use, turnover and license taxes) shall be charged to and remitted by Buyer to Omron.
8. **Financial.** If the financial position of Buyer at any time becomes unsatisfactory to Omron, Omron reserves the right to stop shipments or require satisfactory security or payment in advance. If Buyer fails to make payment or otherwise comply with these Terms or any related agreement, Omron may (without liability and in addition to other remedies) cancel any unshipped portion of Products sold hereunder and stop any Products in transit until Buyer pays all amounts, including amounts payable hereunder, whether or not then due, which are owing to it by Buyer. Buyer shall in any event remain liable for all unpaid accounts.
9. **Cancellation; Etc.** Orders are not subject to rescheduling or cancellation unless Buyer indemnifies Omron against all related costs or expenses.
10. **Force Majeure.** Omron shall not be liable for any delay or failure in delivery resulting from causes beyond its control, including earthquakes, fires, floods, strikes or other labor disputes, shortage of labor or materials, accidents to machinery, acts of sabotage, riots, delay in or lack of transportation or the requirements of any government authority.
11. **Shipping; Delivery.** Unless otherwise expressly agreed in writing by Omron:
  - a. Shipments shall be by a carrier selected by Omron; Omron will not drop ship except in "break down" situations.
  - b. Such carrier shall act as the agent of Buyer and delivery to such carrier shall constitute delivery to Buyer;
  - c. All sales and shipments of Products shall be FOB shipping point (unless otherwise stated in writing by Omron), at which point title and risk of loss shall pass from Omron to Buyer; provided that Omron shall retain a security interest in the Products until the full purchase price is paid;
  - d. Delivery and shipping dates are estimates only; and
  - e. Omron will package Products as it deems proper for protection against normal handling and extra charges apply to special conditions.
12. **Claims.** Any claim by Buyer against Omron for shortage or damage to the Products occurring before delivery to the carrier must be presented in writing to Omron within 30 days of receipt of shipment and include the original transportation bill signed by the carrier noting that the carrier received the Products from Omron in the condition claimed.
13. **Warranties.** (a) **Exclusive Warranty.** Omron's exclusive warranty is that the Products will be free from defects in materials and workmanship for a period of twelve months from the date of sale by Omron (or such other period expressed in writing by Omron). Omron disclaims all other warranties, express or implied. (b) **Limitations.** OMRON MAKES NO WARRANTY OR REPRESENTATION, EXPRESS OR IMPLIED, ABOUT NON-INFRINGEMENT, MERCHANTABILITY OR FITNESS FOR A PARTICULAR PURPOSE OF THE PRODUCTS. BUYER ACKNOWLEDGES THAT IT ALONE HAS DETERMINED THAT THE PRODUCTS WILL SUITABLY MEET THE REQUIREMENTS OF THEIR INTENDED USE. Omron further disclaims all warranties and responsibility of any type for claims or expenses based on infringement by the Products or otherwise of any intellectual property right. (c) **Buyer Remedy.** Omron's sole obligation hereunder shall be, at Omron's election, to (i) replace (in the form originally shipped with Buyer responsible for labor charges for removal or replacement thereof) the non-complying Product, (ii) repair the non-complying Product, or (iii) repay or credit Buyer an amount equal to the purchase price of the non-complying Product; provided that in no event shall Omron be responsible for warranty, repair, indemnity or any other claims or expenses regarding the Products unless Omron's analysis confirms that the Products were properly handled, stored, installed and maintained and not subject to contamination, abuse, misuse or inappropriate modification. Return of any Products by Buyer must be approved in writing by Omron before shipment. Omron Companies shall not be liable for the suitability or unsuitability or the results from the use of Products in combination with any electrical or electronic components, circuits, system assemblies or any other materials or substances or environments. Any advice, recommendations or information given orally or in writing, are not to be construed as an amendment or addition to the above warranty. See <http://www.omron247.com> or contact your Omron representative for published information.
14. **Limitation on Liability; Etc.** OMRON COMPANIES SHALL NOT BE LIABLE FOR SPECIAL, INDIRECT, INCIDENTAL, OR CONSEQUENTIAL DAMAGES, LOSS OF PROFITS OR PRODUCTION OR COMMERCIAL LOSS IN ANY WAY CONNECTED WITH THE PRODUCTS, WHETHER SUCH CLAIM IS BASED IN CONTRACT, WARRANTY, NEGLIGENCE OR STRICT LIABILITY. Further, in no event shall liability of Omron Companies exceed the individual price of the Product on which liability is asserted.
15. **Indemnities.** Buyer shall indemnify and hold harmless Omron Companies and their employees from and against all liabilities, losses, claims, costs and expenses (including attorney's fees and expenses) related to any claim, investigation, litigation or proceeding (whether or not Omron is a party) which arises or is alleged to arise from Buyer's acts or omissions under these Terms or in any way with respect to the Products. Without limiting the foregoing, Buyer (at its own expense) shall indemnify and hold harmless Omron and defend or settle any action brought against such Companies to the extent based on a claim that any Product made to Buyer specifications infringed intellectual property rights of another party.
16. **Property; Confidentiality.** Any intellectual property in the Products is the exclusive property of Omron Companies and Buyer shall not attempt to duplicate it in any way without the written permission of Omron. Notwithstanding any charges to Buyer for engineering or tooling, all engineering and tooling shall remain the exclusive property of Omron. All information and materials supplied by Omron to Buyer relating to the Products are confidential and proprietary, and Buyer shall limit distribution thereof to its trusted employees and strictly prevent disclosure to any third party.
17. **Export Controls.** Buyer shall comply with all applicable laws, regulations and licenses regarding (i) export of products or information; (ii) sale of products to "forbidden" or other proscribed persons; and (iii) disclosure to non-citizens of regulated technology or information.
18. **Miscellaneous.** (a) **Waiver.** No failure or delay by Omron in exercising any right and no course of dealing between Buyer and Omron shall operate as a waiver of rights by Omron. (b) **Assignment.** Buyer may not assign its rights hereunder without Omron's written consent. (c) **Law.** These Terms are governed by the law of the jurisdiction of the home office of the Omron company from which Buyer is purchasing the Products (without regard to conflict of law principles). (d) **Amendment.** These Terms constitute the entire agreement between Buyer and Omron relating to the Products, and no provision may be changed or waived unless in writing signed by the parties. (e) **Severability.** If any provision hereof is rendered ineffective or invalid, such provision shall not invalidate any other provision. (f) **Setoff.** Buyer shall have no right to set off any amounts against the amount owing in respect of this invoice. (g) **Definitions.** As used herein, "including" means "including without limitation"; and "Omron Companies" (or similar words) mean Omron Corporation and any direct or indirect subsidiary or affiliate thereof.

## Certain Precautions on Specifications and Use

1. **Suitability of Use.** Omron Companies shall not be responsible for conformity with any standards, codes or regulations which apply to the combination of the Product in the Buyer's application or use of the Product. At Buyer's request, Omron will provide applicable third party certification documents identifying ratings and limitations of use which apply to the Product. This information by itself is not sufficient for a complete determination of the suitability of the Product in combination with the end product, machine, system, or other application or use. Buyer shall be solely responsible for determining appropriateness of the particular Product with respect to Buyer's application, product or system. Buyer shall take application responsibility in all cases but the following is a non-exhaustive list of applications for which particular attention must be given:
  - (i) Outdoor use, uses involving potential chemical contamination or electrical interference, or conditions or uses not described in this document.
  - (ii) Use in consumer products or any use in significant quantities.
  - (iii) Energy control systems, combustion systems, railroad systems, aviation systems, medical equipment, amusement machines, vehicles, safety equipment, and installations subject to separate industry or government regulations.
  - (iv) Systems, machines and equipment that could present a risk to life or property. Please know and observe all prohibitions of use applicable to this Product.

NEVER USE THE PRODUCT FOR AN APPLICATION INVOLVING SERIOUS RISK TO LIFE OR PROPERTY OR IN LARGE QUANTITIES WITHOUT ENSURING THAT THE SYSTEM AS A WHOLE HAS BEEN DESIGNED TO ADDRESS THE RISKS, AND THAT THE OMRON'S PRODUCT IS PROPERLY RATED AND INSTALLED FOR THE INTENDED USE WITHIN THE OVERALL EQUIPMENT OR SYSTEM.
2. **Programmable Products.** Omron Companies shall not be responsible for the user's programming of a programmable Product, or any consequence thereof.
3. **Performance Data.** Data presented in Omron Company websites, catalogs and other materials is provided as a guide for the user in determining suitability and does not constitute a warranty. It may represent the result of Omron's test conditions, and the user must correlate it to actual application requirements. Actual performance is subject to the Omron's Warranty and Limitations of Liability.
4. **Change in Specifications.** Product specifications and accessories may be changed at any time based on improvements and other reasons. It is our practice to change part numbers when published ratings or features are changed, or when significant construction changes are made. However, some specifications of the Product may be changed without any notice. When in doubt, special part numbers may be assigned to fix or establish key specifications for your application. Please consult with your Omron's representative at any time to confirm actual specifications of purchased Product.
5. **Errors and Omissions.** Information presented by Omron Companies has been checked and is believed to be accurate; however, no responsibility is assumed for clerical, typographical or proofreading errors or omissions.



**OMRON AUTOMATION AND SAFETY • THE AMERICAS HEADQUARTERS** • Chicago, IL USA • 847.843.7900 • 800.556.6766 • [www.omron247.com](http://www.omron247.com)

**OMRON CANADA, INC. • HEAD OFFICE**

Toronto, ON, Canada • 416.286.6465 • 866.986.6766 • [www.omron247.com](http://www.omron247.com)

**OMRON ELECTRONICS DE MEXICO • HEAD OFFICE**

México DF • 52.55.59.01.43.00 • 01-800-226-6766 • [mela@omron.com](mailto:mela@omron.com)

**OMRON ELECTRONICS DE MEXICO • SALES OFFICE**

Apodaca, N.L. • 52.81.11.56.99.20 • 01-800-226-6766 • [mela@omron.com](mailto:mela@omron.com)

**OMRON ELETRÔNICA DO BRASIL LTDA • HEAD OFFICE**

São Paulo, SP, Brasil • 55.11.2101.6300 • [www.omron.com.br](http://www.omron.com.br)

**OMRON ARGENTINA • SALES OFFICE**

Cono Sur • 54.11.4783.5300

**OMRON CHILE • SALES OFFICE**

Santiago • 56.9.9917.3920

**OTHER OMRON LATIN AMERICA SALES**

54.11.4783.5300

**OMRON EUROPE B.V.** • Wegalaan 67-69, NL-2132 JD, Hoofddorp, The Netherlands. • +31 (0) 23 568 13 00 • [www.industrial.omron.eu](http://www.industrial.omron.eu)

*Authorized Distributor:*

**Automation Control Systems**

- Machine Automation Controllers (MAC) • Programmable Controllers (PLC)
- Operator interfaces (HMI) • Distributed I/O • Software

**Drives & Motion Controls**

- Servo & AC Drives • Motion Controllers & Encoders

**Temperature & Process Controllers**

- Single and Multi-loop Controllers

**Sensors & Vision**

- Proximity Sensors • Photoelectric Sensors • Fiber-Optic Sensors
- Amplified Photomicrosensors • Measurement Sensors
- Ultrasonic Sensors • Vision Sensors

**Industrial Components**

- RFID/Code Readers • Relays • Pushbuttons & Indicators
- Limit and Basic Switches • Timers • Counters • Metering Devices
- Power Supplies

**Safety**

- Laser Scanners • Safety Mats • Edges and Bumpers • Programmable Safety Controllers • Light Curtains • Safety Relays • Safety Interlock Switches

# Mouser Electronics

Authorized Distributor

Click to View Pricing, Inventory, Delivery & Lifecycle Information:

Omron:

[G9SX-NS202-RT DC24](#) [D40A-1C5](#)