

Designed Specially for Projected-plunger-type B3F and B3W Switches

- Available in a range of 9 colours.
- Three sizes of key top available.
 - 4x4mm for 6x6mm switch
 - 9x9 or 12x12mm for 12x12mm switch

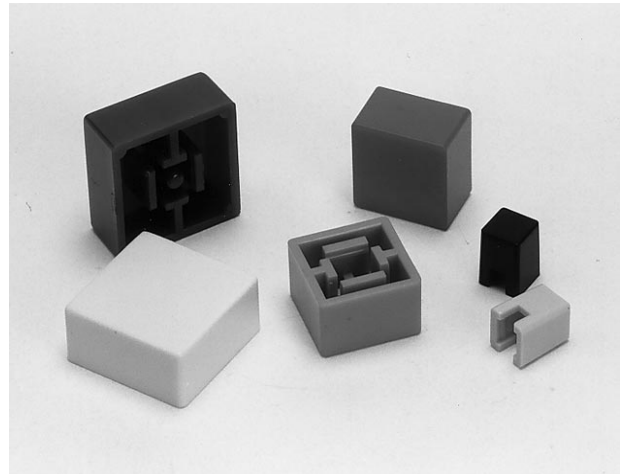

Ordering Information

Available Colours for Key Tops	For 6 x 6 mm switches		For 12 x 12 mm switches	
	4 x 4 mm key top		9 x 9 mm key top	12 x 12 mm key top
Light grey	B32-1000	B32-1200	B32-1300	
Black	B32-1010	B32-1210	B32-1310	
Orange	B32-1020	B32-1220	B32-1320	
Yellow	B32-1030	B32-1230	B32-1330	
Blue	B32-1040	B32-1240	B32-1340	
Green	B32-1050	B32-1250	B32-1350	
White	B32-1060	B32-1260	B32-1360	
Light green	B32-1070	B32-1270	B32-1370	
Red	B32-1080	B32-1280	B32-1380	

Dimensions

B32-10□0

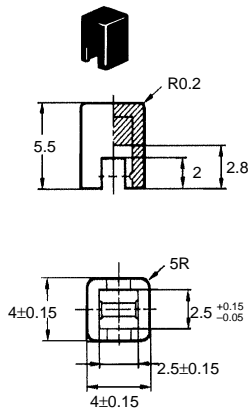

Panel Cutout of
B32-10□0

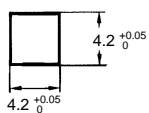

B32-12□0

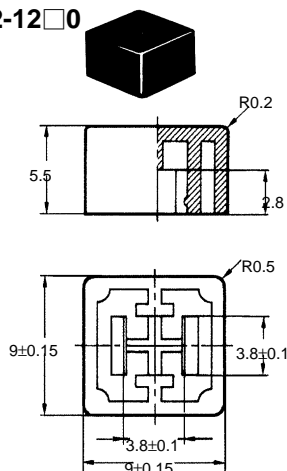

Panel Cutout of
B32-12□0

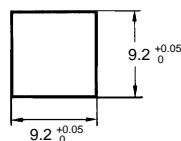

B32-13□0

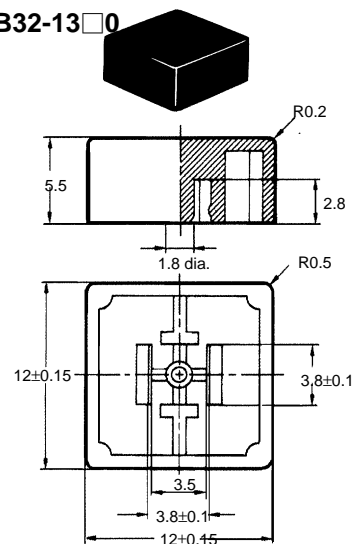

Panel Cutout of
B32-13□0

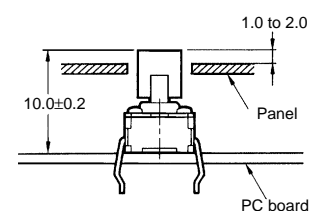
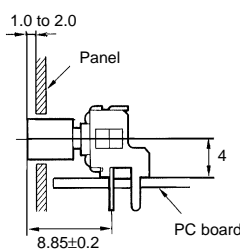
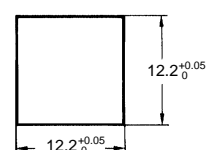

Mouser Electronics

Authorized Distributor

Click to View Pricing, Inventory, Delivery & Lifecycle Information:

[Omron:](#)

[B32-1070](#) [B32-1250](#) [B32-1260](#) [B32-1050](#) [B32-1350](#) [B32-2110](#) [B32-1690](#)