

UM11760

PCA8561AHN-ARD evaluation board

Rev. 1.0 — 21 April 2022

User manual

Document information

| Information | Content |
|-------------|--|
| Keywords | PCA8561AHN, I ² C-bus, LCD, segment driver Arduino port, EVK |
| Abstract | The PCA8561AHN-ARD evaluation board is a daughter card equipped with Arduino port, designated for easy test and design of PCA8561 IC, automotive 18x4 LCD segment driver. The board is fully compliant with IMXRT1050 EVK, LPCXpresso55S69 (LPC55S69-ECK) and i.MX 8M Mini LPDDR4 EVK (8MMINILPD4-EVK, 8MMINID4-EVK), including GUI software control. The board can be attached to any device equipped with an Arduino port. |



Revision history

| Rev | Date | Description |
|-------|----------|-----------------|
| v.1.0 | 20220421 | Initial version |

Important notice

IMPORTANT NOTICE

For engineering development or evaluation purposes only



NXP provides the product under the following conditions:

This evaluation kit is for use of **ENGINEERING DEVELOPMENT OR EVALUATION PURPOSES ONLY**. It is provided as a sample IC pre-soldered to a printed-circuit board to make it easier to access inputs, outputs and supply terminals. This evaluation board may be used with any development system or other source of I/O signals by connecting it to the host MCU computer board via off-the-shelf cables. This evaluation board is not a Reference Design and is not intended to represent a final design recommendation for any particular application. Final device in an application heavily depends on proper printed-circuit board layout and heat sinking design as well as attention to supply filtering, transient suppression, and I/O signal quality.

The product provided may not be complete in terms of required design, marketing, and or manufacturing related protective considerations, including product safety measures typically found in the end device incorporating the product. Due to the open construction of the product, it is the responsibility of the user to take all appropriate precautions for electric discharge. In order to minimize risks associated with the customers' applications, adequate design and operating safeguards must be provided by the customer to minimize inherent or procedural hazards. For any safety concerns, contact NXP sales and technical support services.

1 Introduction

This document describes the PCA8561AHN-ARD evaluation board. The evaluation board is built around the PCA8561, automotive 18x4 LCD segment driver, produced by NXP Semiconductors. The evaluation board serves as a daughter card that can be connected through an Arduino port to various Arduino compatible (including original Arduino Uno R3) EVK / mother boards with the purpose of testing and measuring the characteristics of the PCA8561AHN Device Under Test (DUT).

The PCA8561 IC is an 18x4 LCD segment driver, automotive grade, is built in two variants: the PCA8561AHN equipped with I²C-bus, and PCA8561BHN equipped with SPI-bus. The PCA8561AHN-ARD daughter board is equipped with the I²C-bus version of the LCD driver. The DUT (PCA8561AHN) drives the on-board LCD display "DE301-RS-20/6.35", and is controlled from the mother board through the Arduino port. The board allow the user to test and measure the static and dynamic characteristic of the PCA8561 IC for different configurations specified in the datasheet. The power supply is provided from the same Arduino port.

Additionally, a Graphical User Interface (Windows platform) is provided to facilitate the evaluation of the daughter board. The GUI is used with the following NXP evaluation boards: IMXRT1050 EVK Board, LPCXpresso55S69 Development Board and i.MX 8M Mini LPDDR4 EVK Board.

2 Finding kit resources and information on the NXP web site

NXP Semiconductors provides online resources for evaluation board and its supported device(s) on <http://www.nxp.com>.

The information page for PCA8561AHN-ARD evaluation board is at <http://www.nxp.com/PCA8561AHN-ARD>. The information page provides overview information, documentation, software and tools, parametrics, ordering information and a **Getting Started** tab. The Getting Started tab provides quick-reference information applicable to using the PCA8561AHN-ARD evaluation board, including the downloadable assets referenced in this document.

2.1 Collaborate in the NXP community

The NXP community is for sharing ideas and tips, ask and answer technical questions, and receive input on just about any embedded design topic.

The NXP community is at <http://community.nxp.com>.

3 Getting ready

Working with the PCA8561AHN-ARD requires the kit contents, additional hardware, and a Windows PC workstation with installed software.

3.1 Kit contents

- Assembled and tested evaluation board in an antistatic bag
- Quick Start Guide

3.2 Assumptions

Familiarity with the I²C bus is helpful but not required.

3.3 Static handling requirements

| CAUTION | |
|---|---|
|  | This device is sensitive to ElectroStatic Discharge (ESD). Therefore care should be taken during transport and handling. You must use a ground strap or touch the PC case or other grounded source before unpacking or handling the hardware. |

3.4 Minimum system requirements

This evaluation board requires a Windows PC workstation. Meeting these minimum specifications should produce great results when working with this evaluation board.

- Computer with Windows 10
- One USB port (either 3.0 or 2.0 or 1.1 compatible)
- One of three EVK boards (MIMXRT1050-EVK, LPC55S69-EVK, 8MMINILPD4-EVK) along with the associated firmware / GUI software
- USB cable for power and data connection between PC and EVK board (if not included in the EVK package)

4 Getting to know the hardware

4.1 PCA8561AHN-ARD features

- Equipped with Arduino Uno R3 port for direct connection with Arduino devices;
- On-board reset switch;
- On-board jumpers for I²C address;
- Fully compliant with IMXRT1050 EVK board, including GUI (Windows 10);
- Fully compliant with LPCXpresso55S69 dev. board, including GUI (Windows 10);
- Compliant with i.MX Mini LPDDR4 EVK board, including GUI (Windows 10);

Note: For i.MX Mini LPDDR4 EVK Board is necessary to use IMX8MMINI-IARD interposer board between the EVK and PCA8561AHN-ARD daughter board (see IMX8MMINI-IARD User Manual).

4.2 Kit featured components

[Figure 1](#) identifies the main components on the board. The main elements are called out in the picture. The Arduino port connectors (J1, J4, J5, J6) are located on the bottom side of the board.

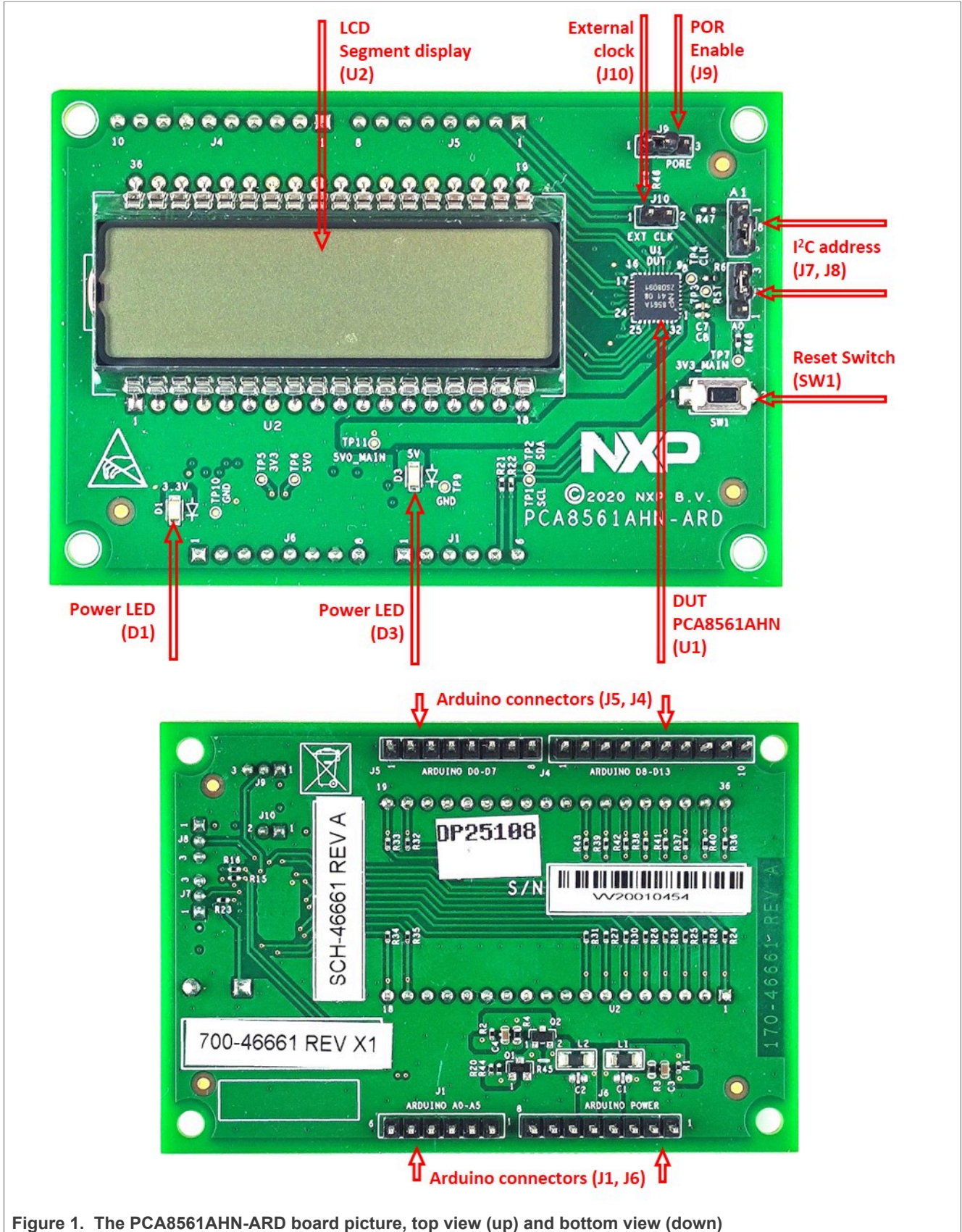

Figure 1. The PCA8561AHN-ARD board picture, top view (up) and bottom view (down)

4.3 Schematic diagram

The schematic diagram of PCA8561AHN-ARD is available at URL: <http://www.nxp.com/PCA8561AHN-ARD>.

4.4 Arduino port

J1, J4, J5, and J6 are the mated pin headers of Arduino Uno R3 connectors, having the same electrical function and placed on the board, so that the daughter board can be directly inserted in the Arduino port. The daughter card is using only four signal lines.

[Table 1](#) represents the pin chart of connectors, and the lines used in the circuit (see also the SPF-46661_A.pdf schematic file):

Table 1. The pin chart of Arduino connectors and their usage

| Ref Des | # | Arduino label | PCA8561AHN-ARD function |
|---|---|------------------|-------------------------|
| J6 (Power) | 1 | NC | Not used |
| | 2 | IOREF | Not used |
| | 3 | RESET | Not used |
| | 4 | 3.3V | Not used |
| | 5 | 5V | Power supply |
| | 6 | GND | Power supply return |
| | 7 | GND | Power supply return |
| | 8 | Vin | Not used |
| J1 (analog, digital, I²C) | 1 | A0 | Not used |
| | 2 | A1 | Not used |
| | 3 | A2 | Not used |
| | 4 | A3 | Not used |
| | 5 | A4 / SDA | I ² C – SDA |
| | 6 | A5 / SCL | I ² C – SCL |
| J5 (digital, UART, PWM) | 1 | D0 / RX | RST |
| | 2 | D1 / TX | CLK_CONN |
| | 3 | D2 | Not used |
| | 4 | D3 / PWM | Not used |
| | 5 | D4 | Not used |
| | 6 | D5 / PWM | Not used |
| | 7 | D6 / PWM | Not used |
| | 8 | D7 | Not used |
| J4 (mixed) | 1 | D8 | Not used |
| | 2 | D9 / PWM | Not used |
| | 3 | D10 / SS / PWM | Not used |
| | 4 | D11 / MOSI / PWM | Not used |
| | 5 | D12 / MISO | Not used |

Table 1. The pin chart of Arduino connectors and their usage...continued

| Ref Des | # | Arduino label | PCA8561AHN-ARD function |
|---------|----|---------------|-------------------------|
| | 6 | D13 / SCK | Not used |
| | 7 | GND | Power supply return |
| | 8 | AREF | Not used |
| | 9 | A4 / SDA | Not used |
| | 10 | A5 / SCL | Not used |

The circuit is supplied from Arduino port through J6 and J4. Pin no. 4 of J6 is 3.3 V power supply while pin no. 5 of J6 is 5 V power supply. Pin no. 6, 7 of J6, and pin no. 7 of J4 represents the power supply return (ground).

4.5 LCD driver

Figure 2 shows the LCD driver and display section of PCA8561AHN-ARD schematic diagram. The DUT (U1) is controlled through the I²C-bus (A5 / SCL and A4 / SDA, Arduino connector J1). The I²C port of PCA8561AHN are pin 8 for SCL, and pin 9 for SDA. R15 and R16 are the I²C pull-up resistors.

The reset input (U1, pin 5) can be activated locally by pressing the on-board switch SW1, or remote from the GUI software through the Arduino port (connector J5, pin 1).

The PCA8561 IC has an internal clock that can also be clocked externally. The external clock is provided from the EVK through pin 2 of the Arduino connector J5. When the internal clock is used, the CLK pin of DUT (U1, pin 7) can be configured as output which provides the clock signal. In this case, the jumper header J10 shall be removed. When the external clock is used, J10 shall be installed, and U1 configured to work with external clock.

The PCA8561 drives the “DE301-RS-20/6.35” LCD display (U2). The U2 has an eight-character display, but the driver controls only four (most significant) characters.

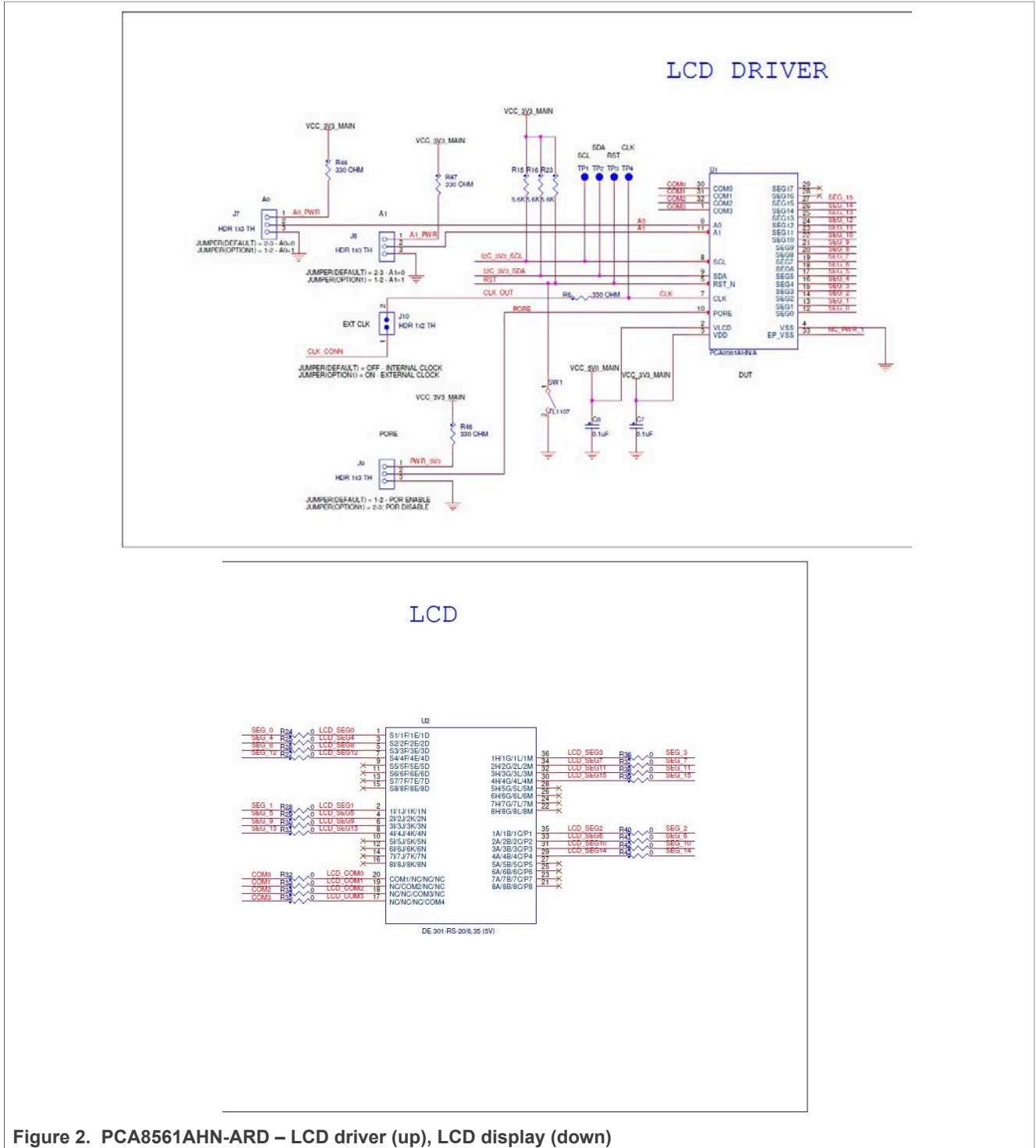

Figure 2. PCA8561AHN-ARD – LCD driver (up), LCD display (down)

4.6 Power supply

Figure 3 depicts the power supply section of schematic diagram (SPF-46661_A.pdf file). The board is supplied with 3.3 V, and 5 V, both voltages being supplied by the Arduino port. LED D1 is the 3.3 V power supply indicator (VCC_3V3_MAIN power net). The LED D3 is the 5V power supply indicator and D2 is 5 V power supply indicator

(VCC_5V_MAIN power net). The transistors Q1 and Q2 assures the required power-up and power-down sequence of the LCD driver. See the power sequences section in the PCA8561 datasheet.

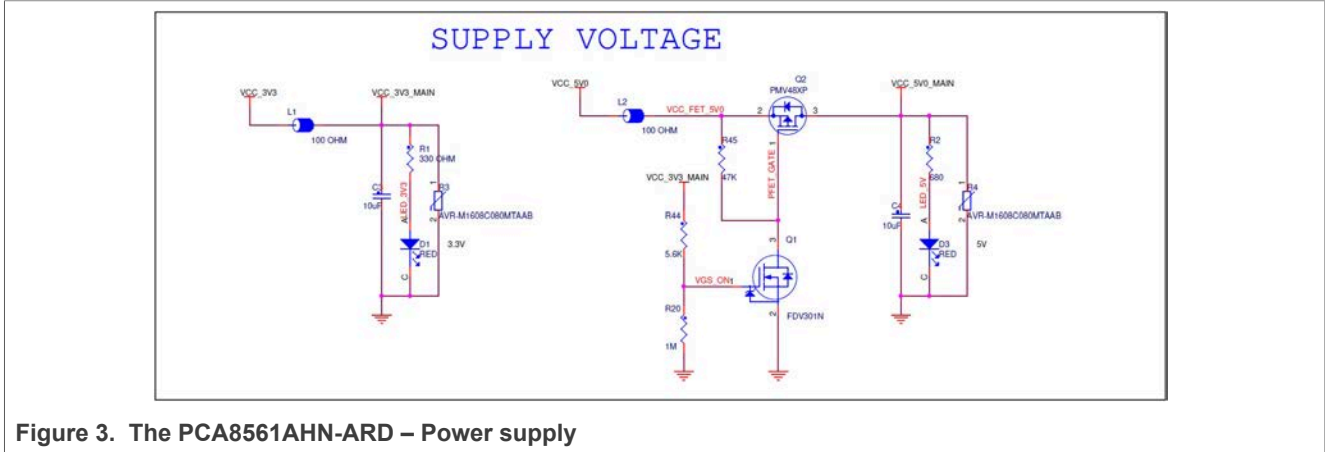

Figure 3. The PCA8561AHN-ARD – Power supply

4.7 Jumpers and test points

The board is containing four jumpers and several test points. [Table 2](#) and [Figure 4](#) details the jumper locations and their default configurations. [Table 3](#) describes the test points located on the PCA8561AHN-ARD board.

Table 2. PCA8561AHN-ARD jumpers

| Ref Des | Label | Default | Description |
|---------|---------|---------|-----------------------------|
| J7 | A0 | 2-3 | 1-2: A0 = 1 |
| | | | 2-3: A0 = 0 |
| J8 | A1 | 2-3 | 1-2: A1 = 1 |
| | | | 2-3: A1 = 0 |
| J9 | PORE | 1-2 | 1-2: Power on Reset Enable |
| | | | 2-3: Power on Reset Disable |
| J10 | EXT CLK | OFF | OFF: Internal clock |
| | | | ON (1-2): External clock |

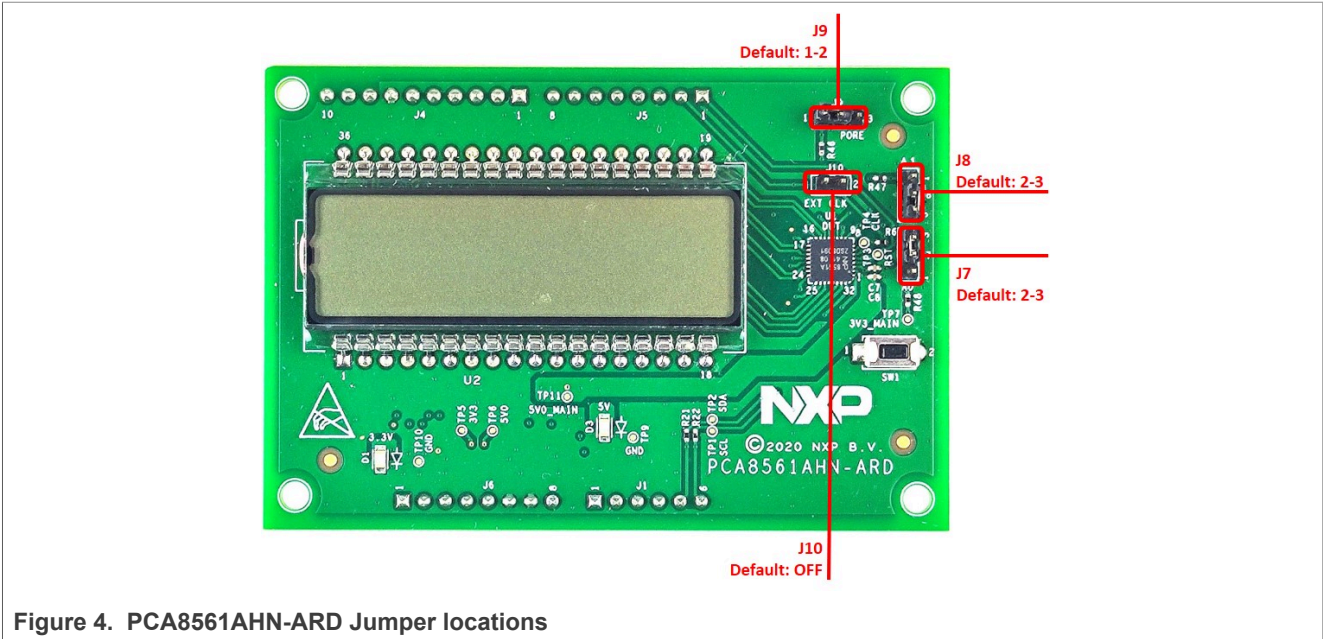

Figure 4. PCA8561AHN-ARD Jumper locations

Table 3. PCA8561AHN-ARD test points

| Ref Des | Test point / jumper label | Description |
|---------|---------------------------|-----------------------------|
| TP1 | SCL | I ² C SCL line |
| TP2 | SDA | I ² C SDA line |
| TP3 | RST | Reset |
| TP4 | CLK | Clock |
| TP5 | 3V3 | VCC_3V3 rail (Arduino port) |
| TP6 | 5V0 | VCC_5V0 rail (Arduino port) |
| TP7 | 3V3_MAIN | VCC_3V3_MAIN rail |
| TP9 | GND | Ground |
| TP10 | GND | Ground |
| TP11 | 5V0_MAIN | VCC_5V0_MAIN rail |

5 Installing and configuring software tools

PCA8561AHN_ARD evaluation board is designed and built as a daughter board able to work in conjunction with a mother board equipped with an Arduino port. The board was built to be fully compatible with the following NXP Evaluation (EVK) boards:

- IMXRT1050 EVK Board;
- LPCXpresso55S69 Development Board;
- i.MX 8M Mini LPDDR4 EVK Board;

Each above mentioned evaluation/development board benefits by firmware support which can be downloaded from NXP company site (www.nxp.com/). Before starting, the EVK motherboard must be programmed with the corresponding firmware package. Additionally, a GUI application (Windows 10) is available for download

from the NXP site, allowing rapid testing and operation of PCA8561AHN-ARD daughter board through the one of above mentioned EVK. For details regarding installation of the EVK firmware and GUI host software on PC please download [EVK_Firmware_And_GUI_Install_Guide_For_Arduino_Boards.pdf](#) instruction file from NXP site (www.nxp.com/). Once the software is installed, the first step is to select the correct combination EVK – PCA8561AHN-ARD daughter card, and then the board can be controlled from the GUI interface. See [Section 6](#) and [Section 7](#) for more details regarding the operation of PCA8561AHN-ARD from GUI software.

6 Configuring the hardware

6.1 Using the PCA8561AHN-ARD with an IMXRT1050 EVK board

[Figure 5](#) shows the required hardware for operation of the PCA8561AHN-ARD daughter board with IMXRT1050 EVK. The following items are necessary:

- One IMXRT1050-EVK board
- One PCA8561AHN-ARD daughter board
- One USB-A / USB Micro-B cable
- A PC with Windows 10 operating system

The IMXRT1050 EVK mother board can be powered by one of the three methods:

- Connecting an external 5VDC power supply to the barrel power connector (J2) on the board
- Connecting an USB cable from the PC to the Micro-B USB connector (J9) on the board
- Connecting an USB cable from the PC to the USB connector (J28) on the board. When the PC is connected in this fashion, the USB port can simultaneously act as a debug interface. Therefore, by using a single USB cable connected to J28, the EVK can be powered and at the same time linked to the PC for data exchange.

The older USB ports (from PC) are not able to deliver the necessary current (500mA), before establishing the communication, use an external power supply (connected to J2).

From J1 on the EVK board (see [Figure 5](#)) the user can select the power configuration for the mother board. For further details, see the [i.MX RT1050 Processor Reference Manual](#)

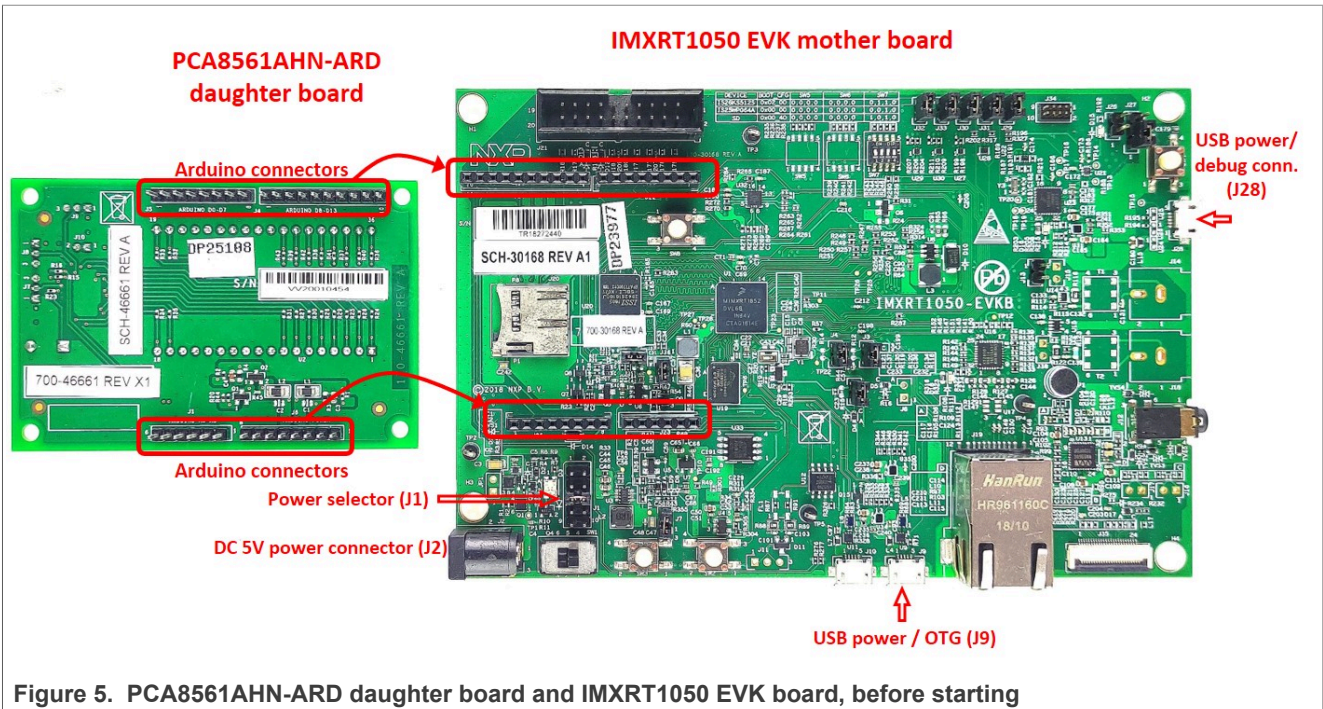

Figure 5. PCA8561AHN-ARD daughter board and IMXRT1050 EVK board, before starting

To configure the hardware and workstation, complete the following procedure:

1. Configure the suitable power configuration of EVK (J1). If using J28 for power supply, the J1 jumper shall be placed in position 5-6. If using an external power supply (connected to J2), the jumper J1 will be placed in position 1-2
2. Insert the PCA8561AHN-ARD daughter card on the Arduino connector of the EVK (see [Figure 5](#))
3. Using USB connector J28, connect the EVK board to an USB port of the computer
4. Install the IMXRT1050 target firmware (download from NXP site and see UM11581, [Arduino shields GUI and firmware installation manual](#) for step-by-step instructions)
5. Install GUI application (see [UM11581, Arduino shields GUI and firmware installation manual](#))
6. Open the GUI application to operate the device from the PC. For details regarding GUI operation see section 8 “GUI description”

[Figure 6](#) shows the boards during the operation.

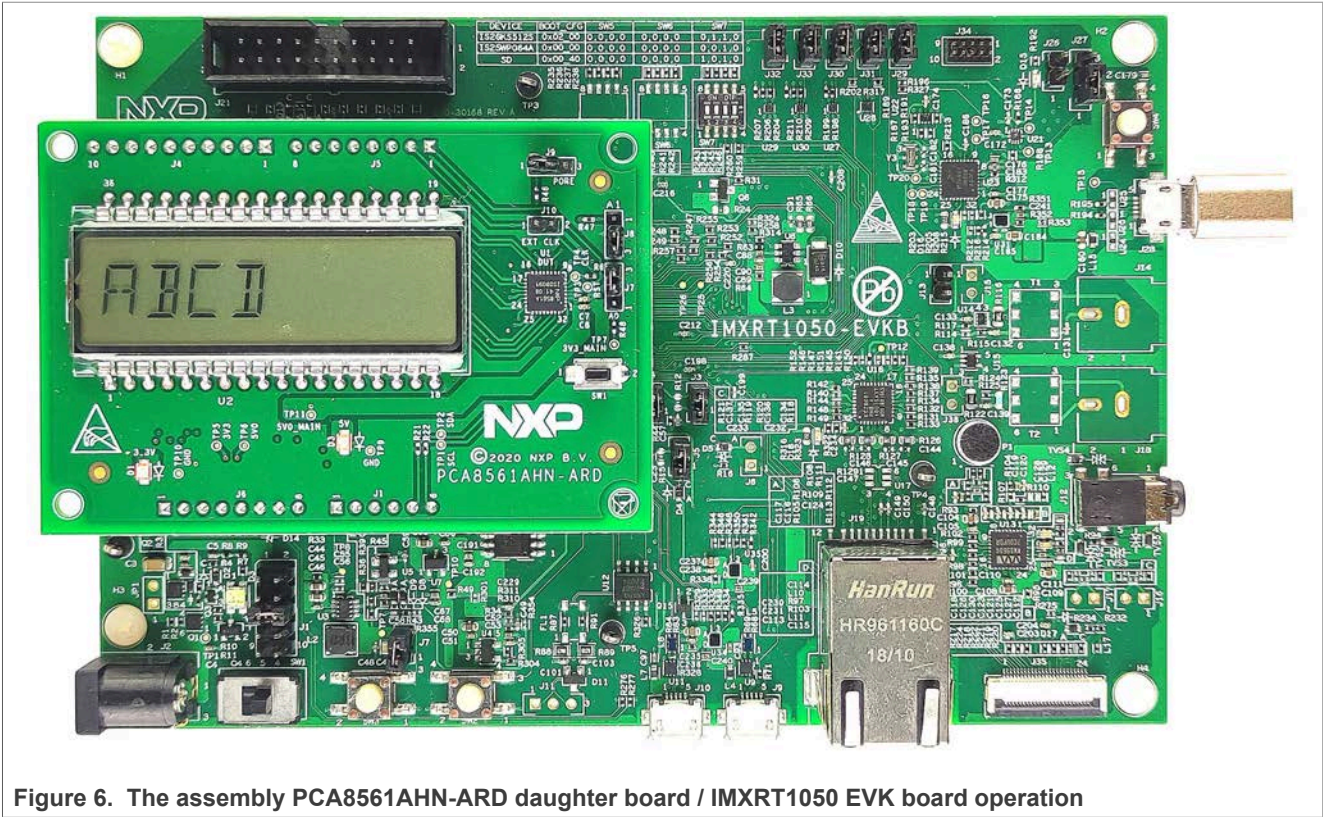

Figure 6. The assembly PCA8561AHN-ARD daughter board / IMXRT1050 EVK board operation

6.2 Using the PCA8561AHN-ARD with an LPCXpresso55S69 development board

Figure 7 shows the required hardware for operation of the PCA8561AHN-ARD and LPCXpresso55S69 EVK board. This configuration consists of:

- One LPCXpresso55S69 EVK board
- One PCA8561AHN-ARD daughter board
- One USB-A / USB Micro-B cable
- A PC with Windows 10 operating system

The LPCXpresso55S69 development board is equipped with four USB Micro-B connectors: P5, P6, P9 and P10. The board can be powered through any USB port. Using P6 USB connector to connect the board to the PC simplifies the start-up operation because P6 is designated for debugging and the USB cable thus accomplishes two tasks at the same time: powering the board, and serving as a data link between the EVK board and PC. For more details regarding power-up and operation of the LPCXpresso55S69 development board, see the *LPCXpresso55S69/LPCXpresso55S28 Development Board User Manual* [here](#).

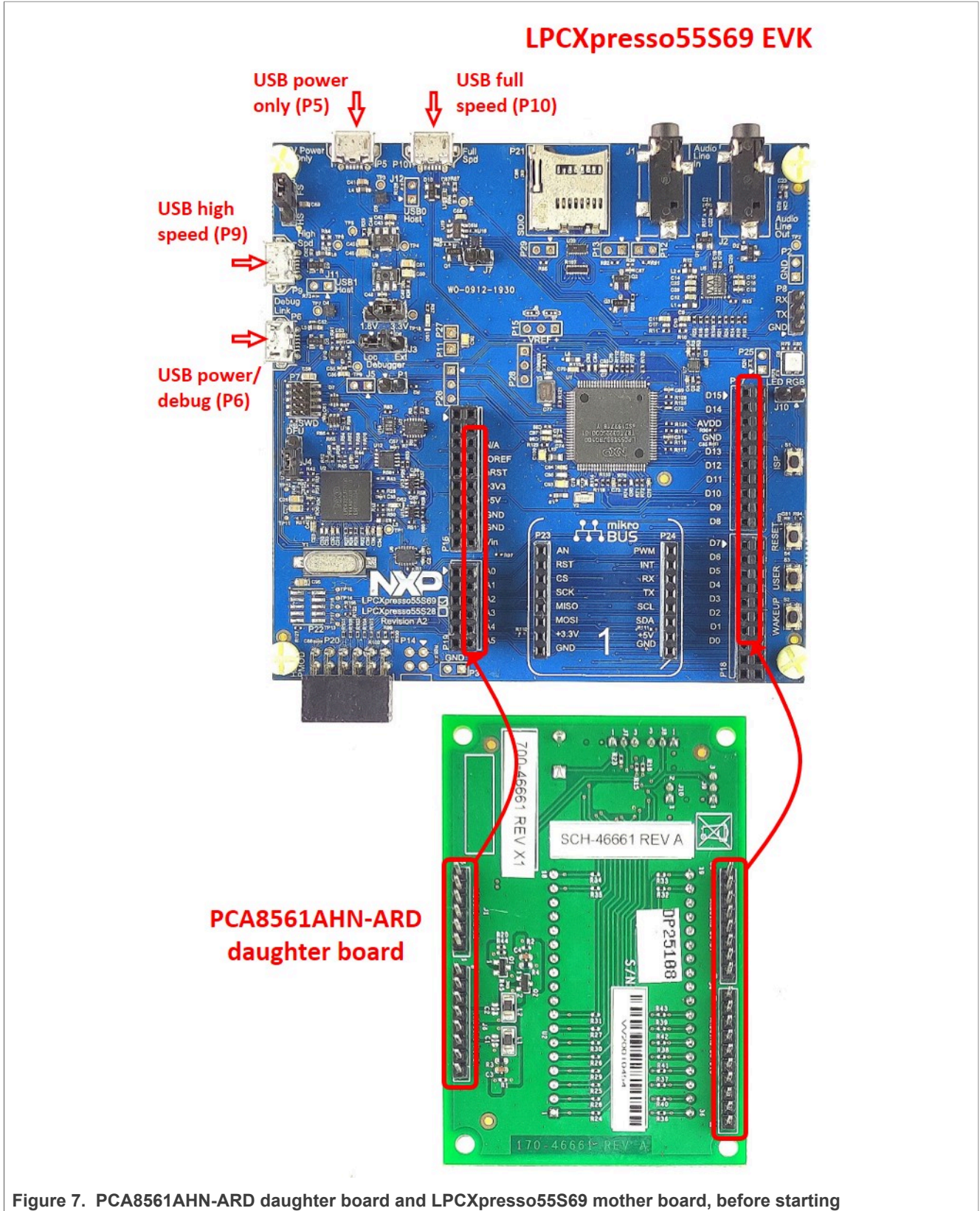

6.3 Using the PCA8561AHN-ARD with an i.MX 8M Mini LPDDR4 EVK board

When an i.MX 8M Mini LPDDR4 EVK board is used with the PCA8561AHN-ARD board, a third board (IMX8MMINI-IARD interposer board) must be used, especially designed and built as EVK – daughter board interconnection. The EVK board i.MX 8M Mini LPDDR4 is not equipped with an Arduino port; instead it has a 2 x 20 pin expansion connector (J1003, see i.MX 8M Mini LPDDR4 EVK user manual). J1003 is a multipurpose port, containing various digital I/O lines, including specialized I²C and SPI buses. Starting from the expansion connector pin chart, an Arduino port interposer board was developed, with the role of signal-to-signal bridge between the 2 x 20 connector pins on the i.MX 8M Mini LPDDR4 EVK and the mated connectors of the Arduino port present on the PCA8561AHN-ARD daughter board.

To operate the setup, along with the EVK and the daughter board, a third board must be included in the setup assembly. [Figure 9](#) shows the necessary boards and how these boards are connected. The configuration consists of:

- One i.MX 8M Mini LPDDR4 EVK board
- One PCA8561AHN-ARD daughter board
- One IMX8MMINI-IARD interposer board
- One USB-A / USB-C cable
- One USB-A / USB Micro-B cable
- A PC with Windows 10 operating system

It is recommended to attach the PCA8561AHN-ARD to the Arduino connectors of the IMX8MMINI-IARD interposer board first, and then the resulting assembly to the i.MX 8M Mini LPDDR4 EVK. This can be done by plugging J1 connector located on the interposer board to J1003 connector on the EVK.

To power-up the EVK, an USB-C type cable connected to PORT 2 of the EVK is used. The power switch SW101 on the EVK board must be set to ON position to power-up the setup. Data communication is achieved by routing a separate USB (Micro-B type) cable from an USB port on the PC to debug port (J901) on the EVK (see [Figure 9](#) and [Figure 10](#)).

The user may find details regarding power-up and operation of the setup assembly in 8MMINILPDDR4-EVK user manual and IMX8MMINI-IARD User Manual. The files can be downloaded from www.nxp.com/.

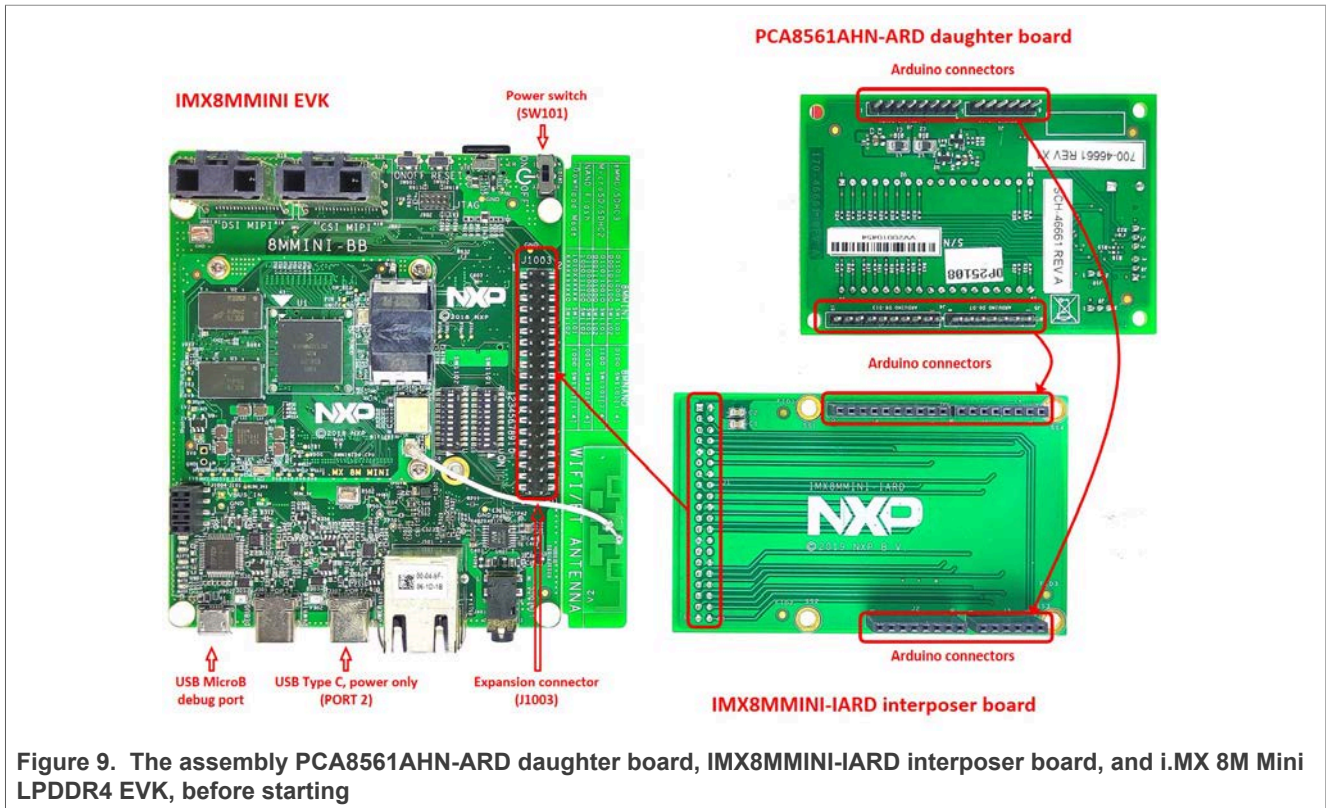

Figure 9. The assembly PCA8561AHN-ARD daughter board, IMX8MMINI-IARD interposer board, and i.MX 8M Mini LPDDR4 EVK, before starting

To configure and operate the setup, follow the below steps:

1. Insert the PCA8561AHN-ARD onto the IMX8MMINI-IARD interposer board Arduino connectors (located on the top side)
2. Attach IMXMMINI-IARD connector plug J1 (located on the bottom of the board) into J1003 expansion board located on the top side of i.MX 8M Mini LPDDR4 EVK (see [Figure 9](#))
3. Power-up the EVK board using an USB Type C cable attached to PORT 2
4. Connect the EVK to the PC, using an USB Micro-B cable, attached to J901 debug port
5. Place SW101 in ON position to power-up the boards
6. Install the MIMXRT1050 target firmware (download [UM11581, Arduino shields GUI and firmware installation manual](#) from NXP site)
7. Install GUI application on the PC (see the instruction file referred in the above step)
8. Open the GUI application to operate the device from the PC. For details regarding GUI operation see [Section 7](#)

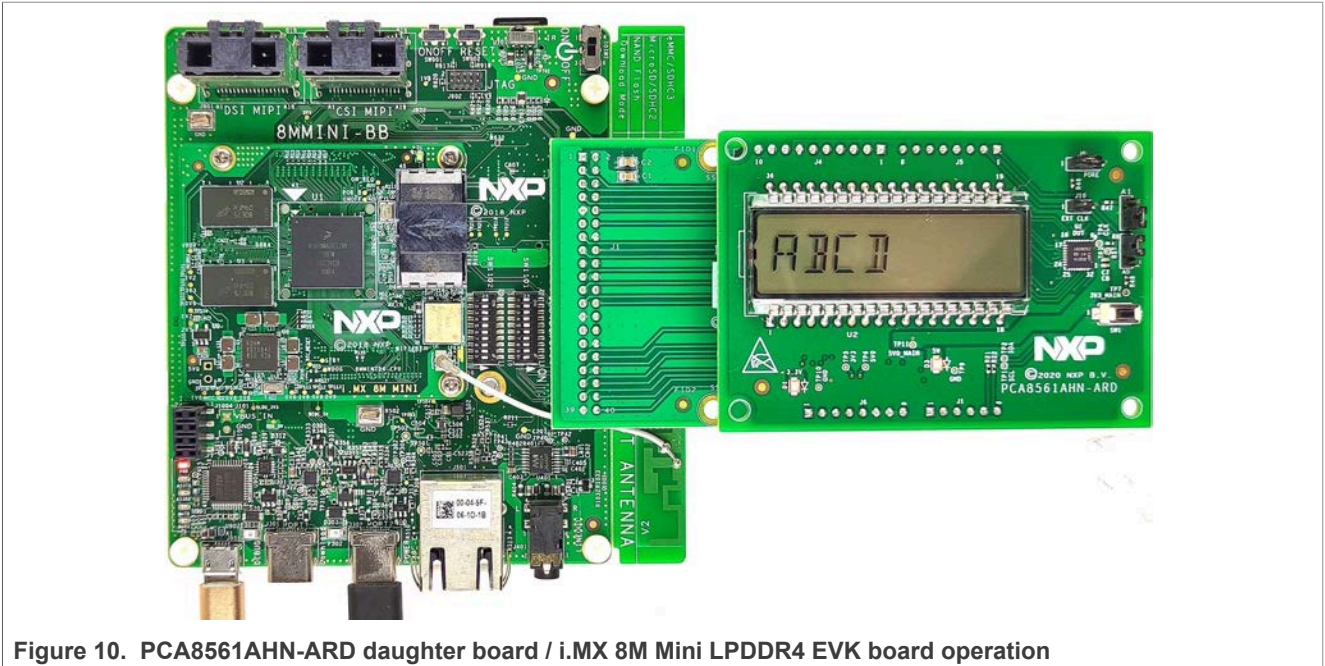

Figure 10. PCA8561AHN-ARD daughter board / i.MX 8M Mini LPDDR4 EVK board operation

6.4 Using PCA8561AHN-ARD with another device

The PCA8561AHN-ARD daughter board can be operated with other EVK board, which has an Arduino port. There are two options to connect the board: using other EVK equipped with an Arduino port, and an EVK without Arduino port. In the first case, a firmware shall be developed according with PCA8561 specifications, and then simply attach PCA8561AHN-ARD daughter board to the EVK, to operate the board. In the second case, using the pin chart of Arduino connectors ([Table 1](#)), make the necessary electrical connections (for power, I²C-bus and control lines), and develop the desired firmware, assuring that is compliant with IC specifications. Use PCA8561 datasheet to read details about internal registers of the DUT IC and data exchange between internal controller and the EVK. Assure for correct electrical connections and avoid data conflicts on the signal lines, to prevent IC damage.

7 GUI description

A GUI application is available for the four EVK boards from NXP Semiconductors. The application is common for all three EVKs described in [Section 6](#).

This section describes the GUI application and how the user can control the PCA8561AHN-ARD daughter board from the graphical interface. First, install the GUI package and software on the PC (Windows 10). For more details, see [UM11581](#).

Once installation is complete, assure that one of the mentioned three EVK with attached PCA8561AHN-ARD daughter board is connected to PC and powered-on. Open “NXP_GUI(PCA8561AHN)” GUI application. An interface will appear as is shown in [Figure 11](#).

The GUI application starts with **SETTINGS** tab (marked with red arrow). The left side of the window displays **Board settings**. The section provides the following settings:

- **Select EVK:** displays the list of EVKs. Selecting a wrong EVK board causes the connection to fail and a pop-up window with the message: *“Unable to Connect with EVK”* appears on the screen.
- **Select COM port:** displays port selected for the communication. The port is automatically selected by the system (in the picture is COM 3).
- **Select Board:** allows the user to select the correct daughter board (the application can support one board only; the setting is redundant).

Assuming the correct parameters are chosen, clicking the **Connect** button establishes the connection with the EVK. In the bottom side of the GUI window a status bar shows in real time the status regarding connection between PC and the EVK.

When the connection between the GUI and the daughter board is established, the on-board LCD display (U2) shows the default message: **“ABCD”**. In the same time, the four-digit display in the GUI (the upper blue region, indicated with the green arrow) is replicating the same message: **“ABCD”**.

In the right side of the window is located **Device setting** section. The one setting is available here, **I2C Address Selection**. The setting selects the device address which must be identical with the selected address from the jumpers J7 and J8, on the PCA8561AHN-ARD daughter board. Any difference between the two addresses will cause the failure to write any internal register of the DUT.

The **Set** button writes the new values in the internal registers of PCA8561 IC. The **Reset Chip** button will bring all internal register of PCA8561 IC in their default state.

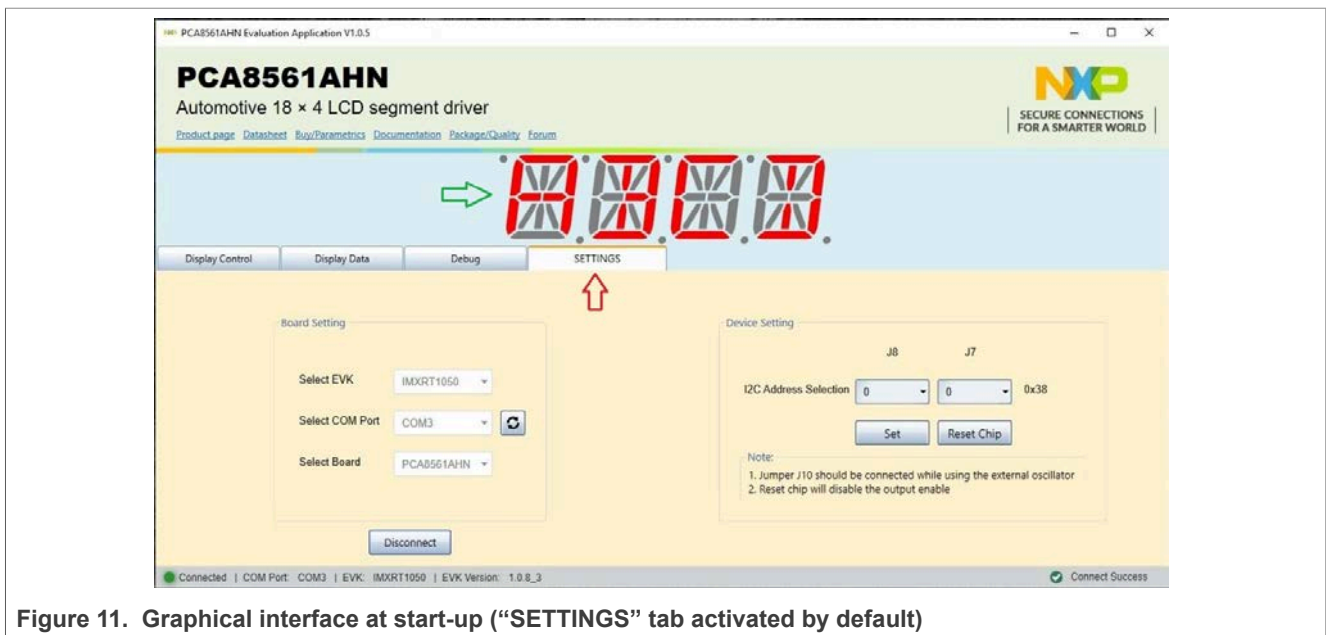

Figure 11. Graphical interface at start-up (“SETTINGS” tab activated by default)

Clicking on the **Display Data** tab, a new window appears, as is shown in [Figure 12](#). From this tab, the user can write messages to be displayed by the LCD display, on the PCA8561AHN-ARD board. The display indicator on the GUI (indicated with the green arrow in [Figure 12](#)) indicates in real time the messages displayed by the LCD (U2). The following settings are provided in the **Display Data** tab:

- **Display All Segment:** ON/OFF command. When ON is selected, the four characters display, including the accent and the dots will light up, regardless of the previous message displayed.

- **Accent:** if selected, turns on the accent for each character.
- **Display:** the message to be displayed by the LCD. Number from 0 to 9, and uppercase characters (A – Z) are allowed, for each digit.
- **Dot:** if selected, turns on the dot for each character.

The **Write** button sets the PCA8561 registers with the values selected in the GUI. Note that, the **Accent**, **Display**, and **Dot** settings are taking effect only **Display All Segment** is OFF. For more details about register map, please see the PCA8561 datasheet.

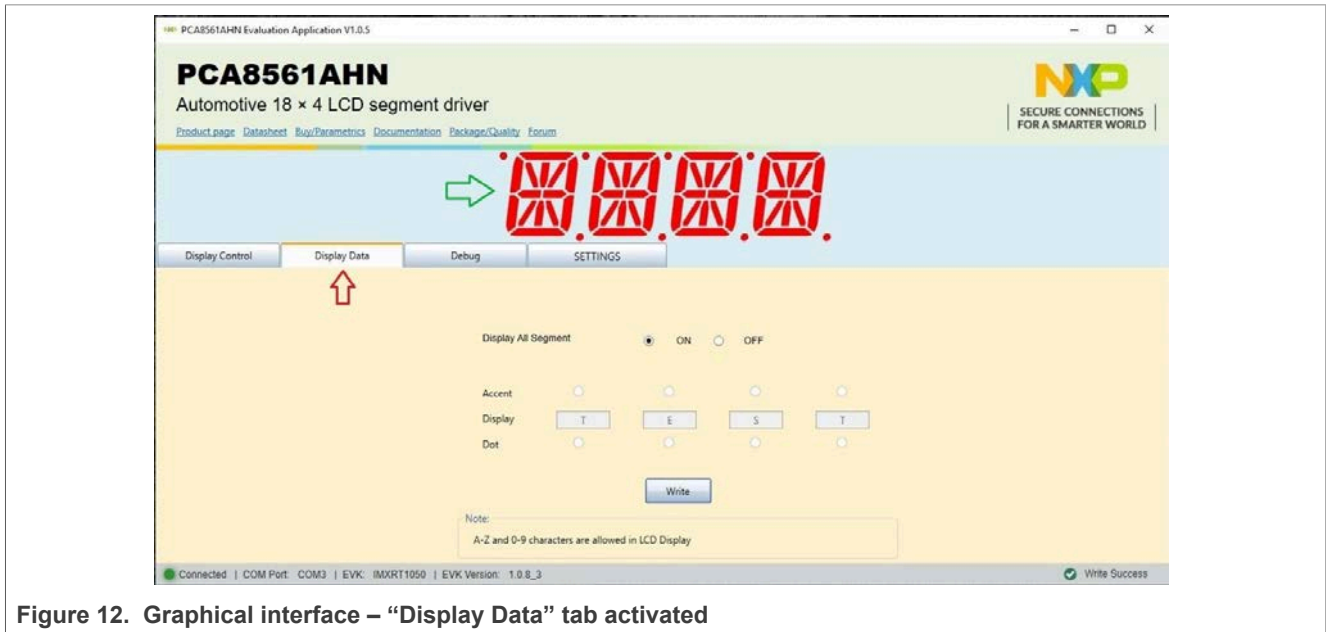

Figure 12. Graphical interface – “Display Data” tab activated

Figure 13 shows the **Display Control** tab. From this tab, the following parameters can be set:

- **Internal Oscillator Control:** Enable/Disable command. Selects the clock source (internal or external). Note that when internal clock is selected, the jumper J10 must be removed, while external clock is selected, the jumper J10 is installed. The external clock signal is applied to pin 7 (U1), which is configured as input.
- **Clock Output Enable:** Enable/Disable command. Selects if the internal clock signal is present at the CLK pin (U1, pin 7) when the internal clock is active. Note that the command is valid only when the **Internal Oscillator Control** is enabled. In this case the CLK pin is configured as output.
- **Display Enable:** Enable/Disable command.
- **Power Drive Scheme:** Selects the level of LCD current. Standard or enhanced (for large area LCD displays). For more details about the power drive mode, see the PCA8561 datasheet.
- **Bias mode selection:** Selects the fractional LCD biasing voltages (1/3, or 1/2). For more details about the power drive mode, see the PCA8561 datasheet.
- **Inversion mode selection:** Selects the line inversion / frame inversion mode. For more details about the power drive mode, see the PCA8561 datasheet.
- **Frame Frequency Selection:** Selects the LCD frame frequency. The available values are: 32 Hz, 64 Hz (default), 96 Hz, 128 Hz, 160 Hz, 192 Hz, 224 Hz, and 256 Hz.
- **Blink Control:** Selects the LCD blinking mode. The available modes are:
 - Blinking off – 0 Hz

- Blinking on – 0.5 Hz
- Blinking on – 1 Hz
- Blinking on – 2 Hz
- **Software Reset:** Initiate a software reset sequence.

The **Write** button sets the PCA8561 registers with the configuration selected in the GUI. The Read button bring back the configuration from the PCA8561 internal registers to the graphical interface.

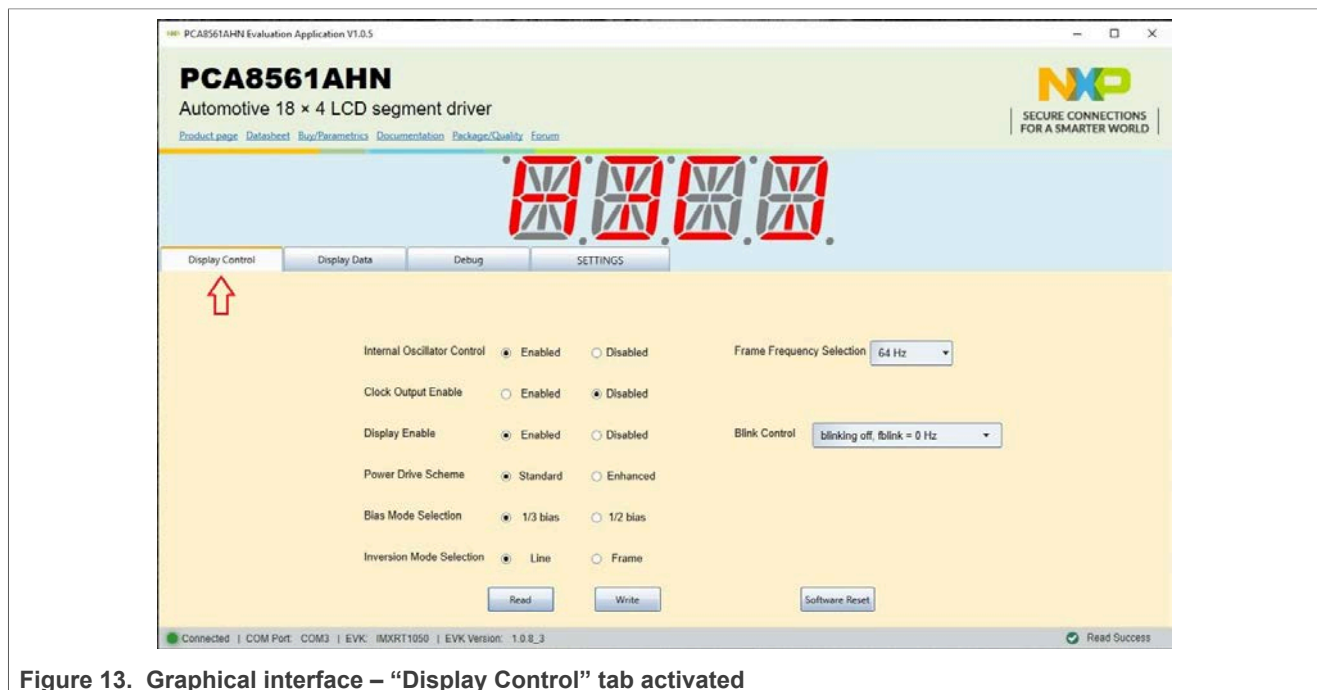

Figure 13. Graphical interface – “Display Control” tab activated

The **Debug** tab (Figure 14) displays the current value of the internal registers of the IC, every time when **Read** button is clicked. To find details about internal registry see the PCAL6534 datasheet.

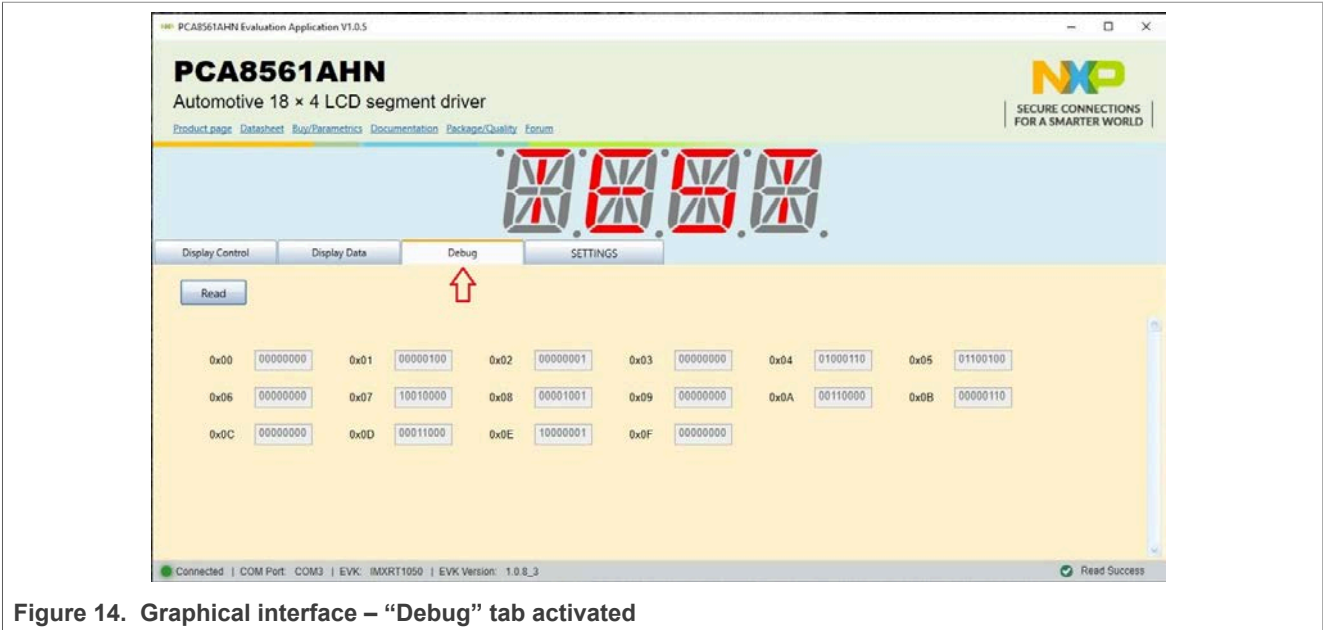

Figure 14. Graphical interface – “Debug” tab activated

8 Abbreviations

Table 4. Abbreviations

| Acronym | Description |
|----------------------|--|
| DUT | Device Under Test |
| EEPROM | Electrically Erasable Read-Only Memory |
| ESD | Electro Static Discharge |
| EVK | Evaluation Board |
| GUI | Graphical User Interface |
| I ² C-bus | Inter-Integrated Circuit bus |
| IC | Integrated Circuit |
| I/O | Input / Output |
| LED | Light Emitting Diode |
| PC | Personal Computer |
| USB | Universal Serial Bus |

9 References

1. *PCA8561, Automotive 18 x 4 LCD segment driver*
Product data sheet; NXP Semiconductors;
2. *MIMxrt1050 EVK Board Hardware User's Guide*
User manual; NXP Semiconductors;
3. *i.MX RT1050 Crossover Processors Data Sheet for Consumer Products*
Data sheet; NXP Semiconductors;
4. *UM11158 – LPCXpresso55S69 Development Board*
User manual; NXP Semiconductors;

5. *LPC556x 32-bit ARM Cortex-M33; M33 coprocessor, TrustZone, PowerQuad, CASPER, 320KB SRAM; 640 KB flash, USB HS, Flexcomm Interface, SDIO, 32-bit counter/timers, SCTimer/PWM, PLU, 16-bit 1.0 Msamples/sec ADC, Comparator, Temperature Sensor, AES, PUF, SHA, CRC, RNG*
Product data sheet; NXP Semiconductors;
6. *i.MX 8M Mini LPDDR4 EVK Board Hardware User's Guide*
User guide; NXP Semiconductors;
7. *i.MX 8M Mini Application Processor Datasheet for Consumer Products*
Data sheet; NXP Semiconductors;
8. *i.MX 8M Mini Application Processor Reference Manual*
Reference manual; NXP Semiconductors;
9. *Arduino Uno R3 Reference Manual*
Reference manual; NXP Semiconductors;
10. *IMX8MMINI-IARD interposer board User Manual*
User manual; NXP Semiconductors;
11. *NXP EVK Firmware and GUI Installation Guide for Arduino Series Boards*
User manual; NXP Semiconductors;

10 Legal information

10.1 Definitions

Draft — A draft status on a document indicates that the content is still under internal review and subject to formal approval, which may result in modifications or additions. NXP Semiconductors does not give any representations or warranties as to the accuracy or completeness of information included in a draft version of a document and shall have no liability for the consequences of use of such information.

10.2 Disclaimers

Limited warranty and liability — Information in this document is believed to be accurate and reliable. However, NXP Semiconductors does not give any representations or warranties, expressed or implied, as to the accuracy or completeness of such information and shall have no liability for the consequences of use of such information. NXP Semiconductors takes no responsibility for the content in this document if provided by an information source outside of NXP Semiconductors.

In no event shall NXP Semiconductors be liable for any indirect, incidental, punitive, special or consequential damages (including - without limitation - lost profits, lost savings, business interruption, costs related to the removal or replacement of any products or rework charges) whether or not such damages are based on tort (including negligence), warranty, breach of contract or any other legal theory.

Notwithstanding any damages that customer might incur for any reason whatsoever, NXP Semiconductors' aggregate and cumulative liability towards customer for the products described herein shall be limited in accordance with the Terms and conditions of commercial sale of NXP Semiconductors.

Right to make changes — NXP Semiconductors reserves the right to make changes to information published in this document, including without limitation specifications and product descriptions, at any time and without notice. This document supersedes and replaces all information supplied prior to the publication hereof.

Suitability for use — NXP Semiconductors products are not designed, authorized or warranted to be suitable for use in life support, life-critical or safety-critical systems or equipment, nor in applications where failure or malfunction of an NXP Semiconductors product can reasonably be expected to result in personal injury, death or severe property or environmental damage. NXP Semiconductors and its suppliers accept no liability for inclusion and/or use of NXP Semiconductors products in such equipment or applications and therefore such inclusion and/or use is at the customer's own risk.

Applications — Applications that are described herein for any of these products are for illustrative purposes only. NXP Semiconductors makes no representation or warranty that such applications will be suitable for the specified use without further testing or modification.

Customers are responsible for the design and operation of their applications and products using NXP Semiconductors products, and NXP Semiconductors accepts no liability for any assistance with applications or customer product design. It is customer's sole responsibility to determine whether the NXP Semiconductors product is suitable and fit for the customer's applications and products planned, as well as for the planned application and use of customer's third party customer(s). Customers should provide appropriate design and operating safeguards to minimize the risks associated with their applications and products.

NXP Semiconductors does not accept any liability related to any default, damage, costs or problem which is based on any weakness or default in the customer's applications or products, or the application or use by customer's third party customer(s). Customer is responsible for doing all necessary testing for the customer's applications and products using NXP Semiconductors products in order to avoid a default of the applications and the products or of the application or use by customer's third party customer(s). NXP does not accept any liability in this respect.

Terms and conditions of commercial sale — NXP Semiconductors products are sold subject to the general terms and conditions of commercial sale, as published at <http://www.nxp.com/profile/terms>, unless otherwise agreed in a valid written individual agreement. In case an individual agreement is concluded only the terms and conditions of the respective agreement shall apply. NXP Semiconductors hereby expressly objects to applying the customer's general terms and conditions with regard to the purchase of NXP Semiconductors products by customer.

Export control — This document as well as the item(s) described herein may be subject to export control regulations. Export might require a prior authorization from competent authorities.

Suitability for use in non-automotive qualified products — Unless this data sheet expressly states that this specific NXP Semiconductors product is automotive qualified, the product is not suitable for automotive use. It is neither qualified nor tested in accordance with automotive testing or application requirements. NXP Semiconductors accepts no liability for inclusion and/or use of non-automotive qualified products in automotive equipment or applications.

In the event that customer uses the product for design-in and use in automotive applications to automotive specifications and standards, customer (a) shall use the product without NXP Semiconductors' warranty of the product for such automotive applications, use and specifications, and (b) whenever customer uses the product for automotive applications beyond NXP Semiconductors' specifications such use shall be solely at customer's own risk, and (c) customer fully indemnifies NXP Semiconductors for any liability, damages or failed product claims resulting from customer design and use of the product for automotive applications beyond NXP Semiconductors' standard warranty and NXP Semiconductors' product specifications.

Translations — A non-English (translated) version of a document, including the legal information in that document, is for reference only. The English version shall prevail in case of any discrepancy between the translated and English versions.

Security — Customer understands that all NXP products may be subject to unidentified vulnerabilities or may support established security standards or specifications with known limitations. Customer is responsible for the design and operation of its applications and products throughout their lifecycles to reduce the effect of these vulnerabilities on customer's applications and products. Customer's responsibility also extends to other open and/or proprietary technologies supported by NXP products for use in customer's applications. NXP accepts no liability for any vulnerability. Customer should regularly check security updates from NXP and follow up appropriately. Customer shall select products with security features that best meet rules, regulations, and standards of the intended application and make the ultimate design decisions regarding its products and is solely responsible for compliance with all legal, regulatory, and security related requirements concerning its products, regardless of any information or support that may be provided by NXP.

NXP has a Product Security Incident Response Team (PSIRT) (reachable at PSIRT@nxp.com) that manages the investigation, reporting, and solution release to security vulnerabilities of NXP products.

10.3 Trademarks

Notice: All referenced brands, product names, service names, and trademarks are the property of their respective owners.

NXP — wordmark and logo are trademarks of NXP B.V.

Tables

| | | | |
|---------|---|---------|-------------------------------------|
| Tab. 1. | The pin chart of Arduino connectors and their usage 8 | Tab. 3. | PCA8561AHN-ARD test points 12 |
| Tab. 2. | PCA8561AHN-ARD jumpers 11 | Tab. 4. | Abbreviations 24 |

Figures

| | | | |
|---------|--|----------|--|
| Fig. 1. | The PCA8561AHN-ARD board picture, top view (up) and bottom view (down) 7 | Fig. 8. | PCA8561AHN-ARD daughter board / LPCXpresso55S69 mother board operation 17 |
| Fig. 2. | PCA8561AHN-ARD – LCD driver (up), LCD display (down) 10 | Fig. 9. | The assembly PCA8561AHN-ARD daughter board, IMX8MMINI-IARD interposer board, and i.MX 8M Mini LPDDR4 EVK, before starting 19 |
| Fig. 3. | The PCA8561AHN-ARD – Power supply 11 | Fig. 10. | PCA8561AHN-ARD daughter board / i.MX 8M Mini LPDDR4 EVK board operation 20 |
| Fig. 4. | PCA8561AHN-ARD Jumper locations 12 | Fig. 11. | Graphical interface at start-up (“SETTINGS” tab activated by default) 21 |
| Fig. 5. | PCA8561AHN-ARD daughter board and IMXRT1050 EVK board, before starting 14 | Fig. 12. | Graphical interface – “Display Data” tab activated 22 |
| Fig. 6. | The assembly PCA8561AHN-ARD daughter board / IMXRT1050 EVK board operation 15 | Fig. 13. | Graphical interface – “Display Control” tab activated 23 |
| Fig. 7. | PCA8561AHN-ARD daughter board and LPCXpresso55S69 mother board, before starting 16 | Fig. 14. | Graphical interface – “Debug” tab activated 24 |

Contents

1 Introduction 4

2 Finding kit resources and information on the NXP web site 4

2.1 Collaborate in the NXP community4

3 Getting ready4

3.1 Kit contents4

3.2 Assumptions 5

3.3 Static handling requirements 5

3.4 Minimum system requirements5

4 Getting to know the hardware 6

4.1 PCA8561AHN-ARD features 6

4.2 Kit featured components6

4.3 Schematic diagram 8

4.4 Arduino port 8

4.5 LCD driver 9

4.6 Power supply 10

4.7 Jumpers and test points 11

5 Installing and configuring software tools 12

6 Configuring the hardware 13

6.1 Using the PCA8561AHN-ARD with an IMXRT1050 EVK board 13

6.2 Using the PCA8561AHN-ARD with an LPCXpresso55S69 development board 15

6.3 Using the PCA8561AHN-ARD with an i.MX 8M Mini LPDDR4 EVK board 18

6.4 Using PCA8561AHN-ARD with another device20

7 GUI description 20

8 Abbreviations 24

9 References 24

10 Legal information 26

Please be aware that important notices concerning this document and the product(s) described herein, have been included in section 'Legal information'.

© NXP B.V. 2022.

All rights reserved.

For more information, please visit: <http://www.nxp.com>

For sales office addresses, please send an email to: salesaddresses@nxp.com

Date of release: 21 April 2022
 Document identifier: UM11760

Mouser Electronics

Authorized Distributor

Click to View Pricing, Inventory, Delivery & Lifecycle Information:

[NXP:](#)

[PCA8561AHN-ARD](#)