



# RF Power LDMOS Transistors

## High Ruggedness N-Channel Enhancement-Mode Lateral MOSFETs

These high ruggedness devices are designed for use in high VSWR industrial, medical, broadcast, aerospace and mobile radio applications. Their unmatched input and output design supports frequency use from 1.8 to 400 MHz.

### Typical Performance

| Frequency (MHz) | Signal Type                         | V <sub>DD</sub> (V) | P <sub>out</sub> (W) | G <sub>ps</sub> (dB) | η <sub>D</sub> (%) |
|-----------------|-------------------------------------|---------------------|----------------------|----------------------|--------------------|
| 87.5–108 (1,2)  | CW                                  | 60                  | 1670 CW              | 23.8                 | 83.5               |
| 230 (3)         | Pulse<br>(100 μsec, 20% Duty Cycle) | 65                  | 1800 Peak            | 24.4                 | 75.7               |

### Load Mismatch/Ruggedness

| Frequency (MHz) | Signal Type                         | VSWR                       | P <sub>in</sub> (W)           | Test Voltage | Result                |
|-----------------|-------------------------------------|----------------------------|-------------------------------|--------------|-----------------------|
| 230 (3)         | Pulse<br>(100 μsec, 20% Duty Cycle) | > 65:1 at all Phase Angles | 14 W Peak<br>(3 dB Overdrive) | 65           | No Device Degradation |

1. Measured in 87.5–108 MHz broadband reference circuit (page 5).
2. The values shown are the center band performance numbers across the indicated frequency range.
3. Measured in 230 MHz narrowband production test fixture (page 11).

### Features

- Unmatched input and output allowing wide frequency range utilization
- Device can be used single-ended or in a push-pull configuration
- Qualified up to a maximum of 65 V<sub>DD</sub> operation
- Characterized from 30 to 65 V for extended power range
- Lower thermal resistance package
- High breakdown voltage for enhanced reliability
- Suitable for linear application with appropriate biasing
- Integrated ESD protection with greater negative gate-source voltage range for improved Class C operation
- Included in NXP product longevity program with assured supply for a minimum of 15 years after launch

### Typical Applications

- Industrial, scientific, medical (ISM)
  - Laser generation
  - Plasma generation
  - Particle accelerators
  - MRI, RF ablation and skin treatment
  - Industrial heating, welding and drying systems
- Radio and VHF TV broadcast
- Aerospace
  - HF communications
  - Radar

**MRFX1K80N**  
**MRFX1K80GN**

**1.8–400 MHz, 1800 W CW, 65 V**  
**WIDEBAND**  
**RF POWER LDMOS TRANSISTORS**

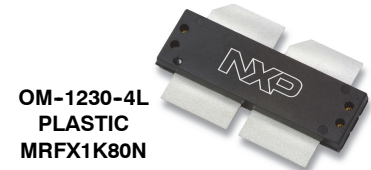

**OM-1230-4L**  
**PLASTIC**  
**MRFX1K80N**



**OM-1230G-4L**  
**PLASTIC**  
**MRFX1K80GN**

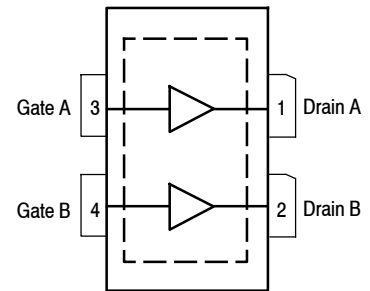

(Top View)

Note: Exposed backside of the package is the source terminal for the transistor.

**Figure 1. Pin Connections**



**Table 1. Maximum Ratings**

| Rating   | Symbol    | Value        | Unit      |
|--|-----------|--------------|-----------|
| Drain-Source Voltage   | $V_{DSS}$ | -0.5, +179   | Vdc       |
| Gate-Source Voltage  | $V_{GS}$  | -6.0, +10    | Vdc       |
| Storage Temperature Range  | $T_{stg}$ | -65 to +150  | °C        |
| Case Operating Temperature Range   | $T_C$     | -40 to +150  | °C        |
| Operating Junction Temperature Range (1,2)                               | $T_J$     | -40 to +225  | °C        |
| Total Device Dissipation @ $T_C = 25^\circ\text{C}$<br>Derate above 25°C | $P_D$     | 3333<br>16.7 | W<br>W/°C |

**Table 2. Thermal Characteristics**

| Characteristic  | Symbol          | Value (2,3) | Unit |
|---|-----------------|-------------|------|
| Thermal Resistance, Junction to Case<br>CW: Case Temperature 112°C, 1800 W CW, 65 Vdc, $I_{DQ(A+B)} = 150$ mA, 98 MHz   | $R_{\theta JC}$ | 0.06        | °C/W |
| Thermal Impedance, Junction to Case<br>Pulse: Case Temperature 77°C, 1800 W Peak, 100 $\mu\text{sec}$ Pulse Width, 20% Duty Cycle,<br>65 Vdc, $I_{DQ(A+B)} = 100$ mA, 230 MHz | $Z_{\theta JC}$ | 0.009       | °C/W |

**Table 3. ESD Protection Characteristics**

| Test Methodology                      | Class             |
|---------------------------------------|-------------------|
| Human Body Model (per JESD22-A114)    | 2, passes 2500 V  |
| Charge Device Model (per JESD22-C101) | C3, passes 1200 V |

**Table 4. Moisture Sensitivity Level**

| Test Methodology                     | Rating | Package Peak Temperature | Unit |
|--------------------------------------|--------|--------------------------|------|
| Per JESD22-A113, IPC/JEDEC J-STD-020 | 3      | 260                      | °C   |

**Table 5. Electrical Characteristics** ( $T_A = 25^\circ\text{C}$  unless otherwise noted)

| Characteristic | Symbol | Min | Typ | Max | Unit |
|----------------|--------|-----|-----|-----|------|
|----------------|--------|-----|-----|-----|------|

**Off Characteristics (4)**

|  |               |     |     |     |                 |
|--|---------------|-----|-----|-----|-----------------|
| Gate-Source Leakage Current<br>( $V_{GS} = 5$ Vdc, $V_{DS} = 0$ Vdc)               | $I_{GSS}$     | —   | —   | 1   | $\mu\text{Adc}$ |
| Drain-Source Breakdown Voltage<br>( $V_{GS} = 0$ Vdc, $I_D = 100$ mAdc)            | $V_{(BR)DSS}$ | 179 | 193 | —   | Vdc             |
| Zero Gate Voltage Drain Leakage Current<br>( $V_{DS} = 65$ Vdc, $V_{GS} = 0$ Vdc)  | $I_{DSS}$     | —   | —   | 10  | $\mu\text{Adc}$ |
| Zero Gate Voltage Drain Leakage Current<br>( $V_{DS} = 179$ Vdc, $V_{GS} = 0$ Vdc) | $I_{DSS}$     | —   | —   | 100 | mAdc            |

**On Characteristics**

|   |              |     |      |     |     |
|---|--------------|-----|------|-----|-----|
| Gate Threshold Voltage (4)<br>( $V_{DS} = 10$ Vdc, $I_D = 740$ $\mu\text{Adc}$ )                      | $V_{GS(th)}$ | 2.1 | 2.5  | 2.9 | Vdc |
| Gate Quiescent Voltage<br>( $V_{DD} = 65$ Vdc, $I_{DQ(A+B)} = 100$ mAdc, Measured in Functional Test) | $V_{GS(Q)}$  | 2.5 | 2.9  | 3.3 | Vdc |
| Drain-Source On-Voltage (4)<br>( $V_{GS} = 10$ Vdc, $I_D = 2.76$ Adc)                                 | $V_{DS(on)}$ | —   | 0.21 | —   | Vdc |
| Forward Transconductance (4)<br>( $V_{DS} = 10$ Vdc, $I_D = 43$ Adc)                                  | $g_{fs}$     | —   | 44.7 | —   | S   |

1. Continuous use at maximum temperature will affect MTF.
2. MTF calculator available at <http://www.nxp.com/RF/calculators>.
3. Refer to AN1955, *Thermal Measurement Methodology of RF Power Amplifiers*. Go to <http://www.nxp.com/RF> and search for AN1955.
4. Each side of device measured separately.

(continued)

**Table 5. Electrical Characteristics** ( $T_A = 25^\circ\text{C}$  unless otherwise noted) (continued)

| Characteristic  | Symbol    | Min | Typ | Max | Unit |
|---|-----------|-----|-----|-----|------|
| <b>Dynamic Characteristics</b> <sup>(1)</sup>   |           |     |     |     |      |
| Reverse Transfer Capacitance<br>( $V_{DS} = 65\text{ Vdc} \pm 30\text{ mV(rms)ac}$ @ 1 MHz, $V_{GS} = 0\text{ Vdc}$ ) | $C_{rss}$ | —   | 5.6 | —   | pF   |
| Output Capacitance<br>( $V_{DS} = 65\text{ Vdc} \pm 30\text{ mV(rms)ac}$ @ 1 MHz, $V_{GS} = 0\text{ Vdc}$ )           | $C_{oss}$ | —   | 216 | —   | pF   |
| Input Capacitance<br>( $V_{DS} = 65\text{ Vdc}$ , $V_{GS} = 0\text{ Vdc} \pm 30\text{ mV(rms)ac}$ @ 1 MHz)            | $C_{iss}$ | —   | 765 | —   | pF   |

**Functional Tests** (In NXP Narrowband Production Test Fixture, 50 ohm system)  $V_{DD} = 65\text{ Vdc}$ ,  $I_{DQ(A+B)} = 100\text{ mA}$ ,  $P_{out} = 1800\text{ W Peak}$  (360 W Avg.),  $f = 230\text{ MHz}$ , 100  $\mu\text{sec}$  Pulse Width, 20% Duty Cycle

|                   |          |      |      |      |    |
|-------------------|----------|------|------|------|----|
| Power Gain        | $G_{ps}$ | 23.0 | 24.4 | 26.0 | dB |
| Drain Efficiency  | $\eta_D$ | 71.0 | 75.7 | —    | %  |
| Input Return Loss | IRL      | —    | -16  | -9   | dB |

**Table 6. Load Mismatch/Ruggedness** (In NXP Narrowband Production Test Fixture, 50 ohm system)  $I_{DQ(A+B)} = 100\text{ mA}$ 

| Frequency (MHz) | Signal Type                                     | VSWR                          | $P_{in}$ (W)                  | Test Voltage, $V_{DD}$ | Result                |
|-----------------|---|-------------------------------|-------------------------------|------------------------|-----------------------|
| 230             | Pulse<br>(100 $\mu\text{sec}$ , 20% Duty Cycle) | > 65:1 at all<br>Phase Angles | 14 W Peak<br>(3 dB Overdrive) | 65                     | No Device Degradation |

**Table 7. Ordering Information**

| Device       | Tape and Reel Information                       | Package     |
|--------------|---|-------------|
| MRFX1K80NR5  | R5 Suffix = 50 Units, 56 mm Tape Width, 13-Reel | OM-1230-4L  |
| MRFX1K80GNR5 |   | OM-1230G-4L |

1. Each side of device measured separately.

## TYPICAL CHARACTERISTICS

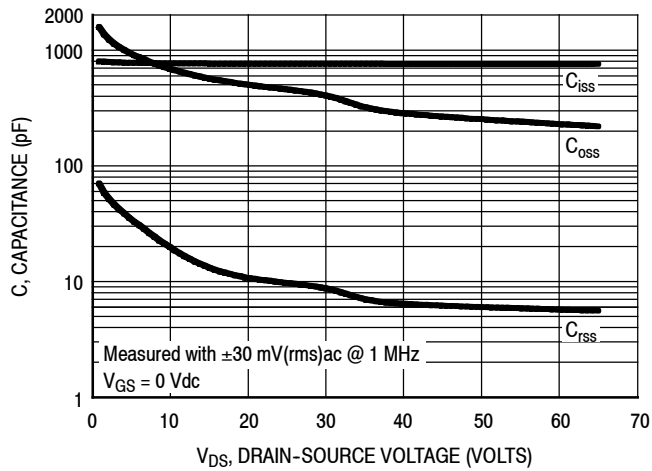

**Note:** Each side of device measured separately.

**Figure 2. Capacitance versus Drain-Source Voltage**

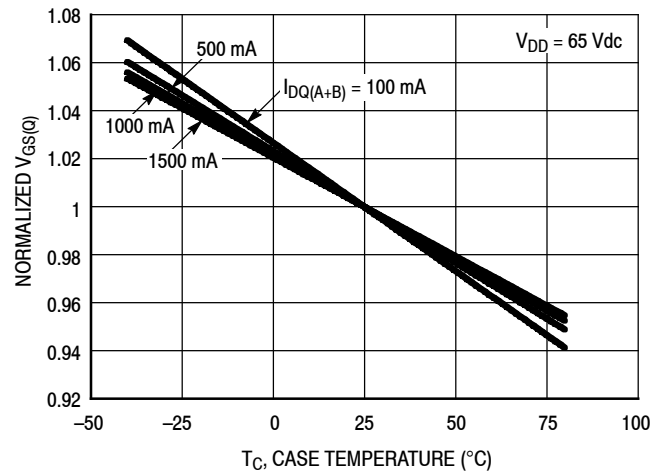

| $I_{DQ}$ (mA) | Slope (mV/°C) |
|---------------|---------------|
| 100           | -3.14         |
| 500           | -2.88         |
| 1000          | -2.75         |
| 1500          | -2.65         |

**Figure 3. Normalized  $V_{GS}$  versus Quiescent Current and Case Temperature**

## 87.5–108 MHz BROADBAND REFERENCE CIRCUIT – 2.9" × 5.1" (7.3 cm × 13.0 cm)

**Table 8. 87.5–108 MHz Broadband Performance** (In NXP Reference Circuit, 50 ohm system)

$I_{DQ(A+B)} = 200 \text{ mA}$ ,  $P_{in} = 7 \text{ W}$ , CW

| Frequency (MHz) | V <sub>DD</sub> (V) | P <sub>out</sub> (W) | G <sub>ps</sub> (dB) | η <sub>D</sub> (%) |
|-----------------|---------------------|----------------------|----------------------|--------------------|
| 87.5            | 60                  | 1580                 | 23.5                 | 84.6               |
| 98              | 60                  | 1670                 | 23.8                 | 83.5               |
| 108             | 60                  | 1600                 | 23.6                 | 80.6               |

**87.5–108 MHz BROADBAND REFERENCE CIRCUIT – 2.9" × 5.1" (7.3 cm × 13.0 cm)**



\*C15 and C23 are mounted vertically.

Note: Component numbers C12 and C13 are not used.

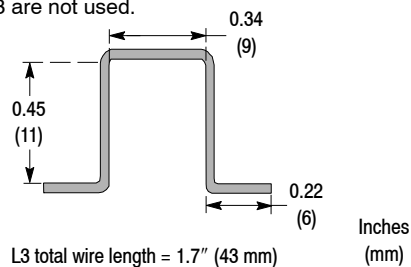

**Figure 4. MRFX1K80N 87.5–108 MHz Broadband Reference Circuit Component Layout**

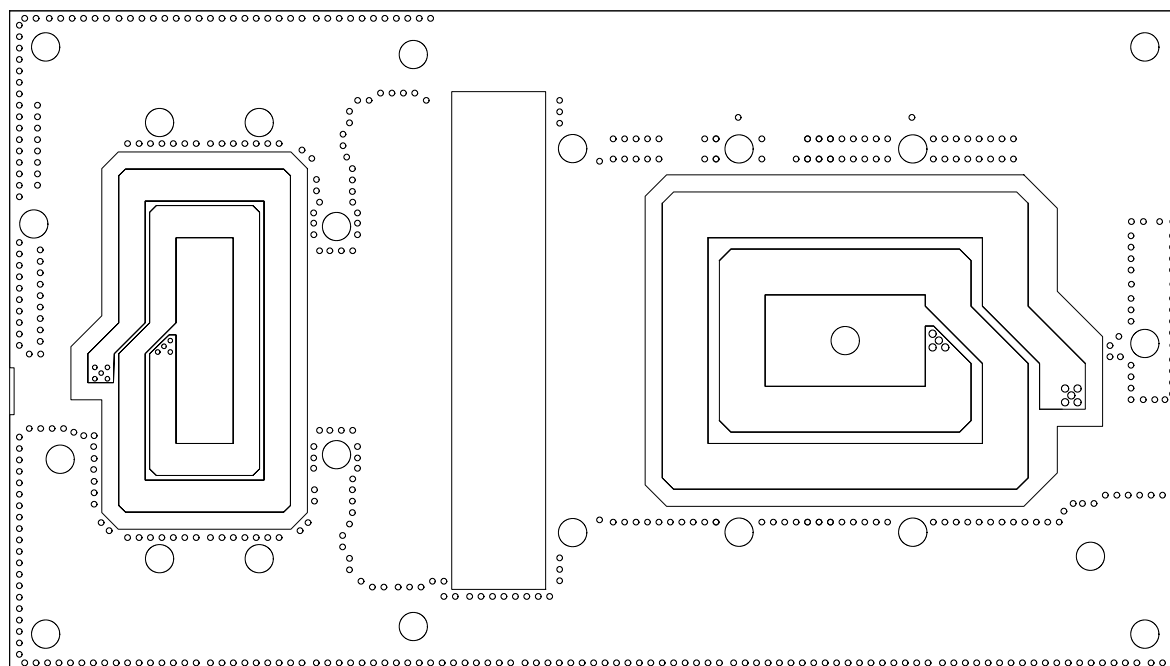

**Figure 5. MRFX1K80N 87.5–108 MHz Broadband Reference Circuit Component Layout – Bottom**

**Table 9. MRFX1K80N 87.5–108 MHz Broadband Reference Circuit Component Designations and Values**

| Part                                    | Description  | Part Number          | Manufacturer            |
|---|--|----------------------|-------------------------|
| C1, C3, C6, C9, C18, C19, C20, C21, C22 | 1000 pF Chip Capacitor   | ATC100B102JT50XT     | ATC                     |
| C2                                      | 33 pF Chip Capacitor   | ATC100B330JT500XT    | ATC                     |
| C4, C5, C8                              | 10,000 pF Chip Capacitor   | ATC200B103KT50XT     | ATC                     |
| C7, C10, C15, C16, C17, C23             | 470 pF Chip Capacitor  | ATC100B471JT200XT    | ATC                     |
| C11                                     | 100 pF, 300 V Mica Capacitor   | MIN02-002EC101J-F    | CDE                     |
| C14, C24                                | 12 pF Chip Capacitor   | ATC100B120GT500XT    | ATC                     |
| C25, C26, C27                           | 220 $\mu$ F, 100 V Electrolytic Capacitor                                    | EEV-FC2A221M         | Panasonic-ECG           |
| C28                                     | 22 $\mu$ F, 35 V Electrolytic Capacitor                                      | UUD1V220MCL1GS       | Nichicon                |
| L1, L2                                  | 17.5 nH Inductor, 6 Turns  | B06TJLC              | Coilcraft               |
| L3                                      | 1.5 mm Non-Tarnish Silver Plated Copper Wire, Total Wire Length = 1.7"/43 mm | SP1500NT-001         | Scientific Wire Company |
| L4                                      | 22 nH Inductor   | 1212VS-22NMEB        | Coilcraft               |
| Q1                                      | RF Power LDMOS Transistor  | MRFX1K80N            | NXP                     |
| R1                                      | 10 $\Omega$ , 1/4 W Chip Resistor  | CRCW120610R0JNEA     | Vishay                  |
| R2, R3                                  | 33 $\Omega$ , 2 W Chip Resistor  | 1-2176070-3          | TE Connectivity         |
| Thermal Pad                             | TG Series Soft Thermal Conductive Pad  | TG6050-150-150-5.0-0 | t-Global Technology     |
| PCB                                     | Rogers TC350 0.030", $\epsilon_r = 3.5$                                      | D94850               | MTL                     |

Note: Refer to MRFX1K80N's [printed circuit boards and schematics](#) to download the 87.5–108 MHz baseplate drawing.

## TYPICAL CHARACTERISTICS – 87.5–108 MHz BROADBAND REFERENCE CIRCUIT



**Figure 6. Power Gain, Drain Efficiency and CW Output Power versus Frequency at a Constant Input Power**



**Figure 7. CW Output Power versus Input Power and Frequency**

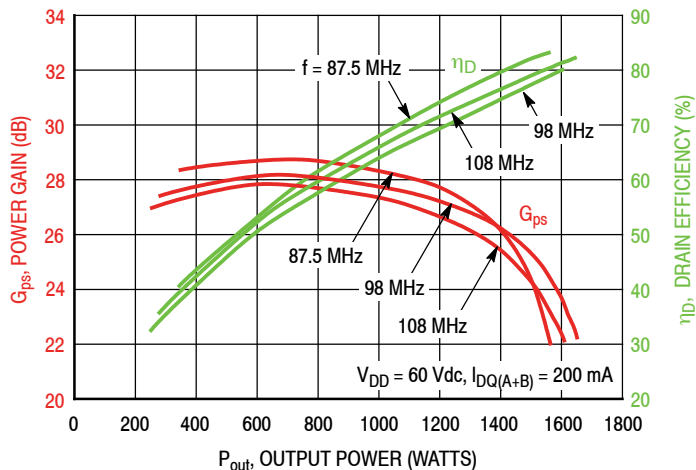

**Figure 8. Power Gain and Drain Efficiency versus CW Output Power and Frequency**



### 87.5–108 MHz BROADBAND REFERENCE CIRCUIT



| f<br>MHz | $Z_{source}$<br>$\Omega$ | $Z_{load}$<br>$\Omega$ |
|----------|--------------------------|------------------------|
| 87.5     | $1.65 + j3.30$           | $3.90 + j4.73$         |
| 98       | $1.91 + j3.25$           | $3.88 + j3.99$         |
| 108      | $1.94 + j2.87$           | $3.35 + j3.95$         |

$Z_{source}$  = Test circuit impedance as measured from gate to gate, balanced configuration.

$Z_{load}$  = Test circuit impedance as measured from drain to drain, balanced configuration.

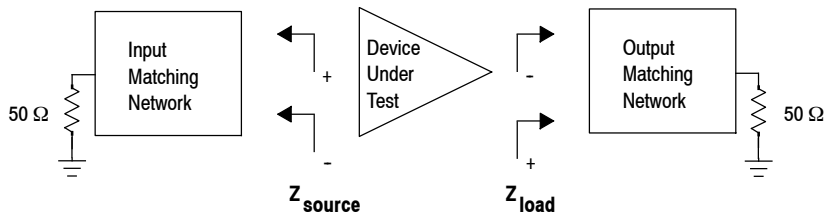

Figure 9. Broadband Series Equivalent Source and Load Impedance – 87.5–108 MHz

**HARMONIC MEASUREMENTS — 87.5–108 MHz  
BROADBAND REFERENCE CIRCUIT**



**Figure 10. 87.5 MHz Harmonics @ 1500 W CW**

## 230 MHz NARROWBAND PRODUCTION TEST FIXTURE – 6.0" x 4.0" (15.2 cm x 10.2 cm)

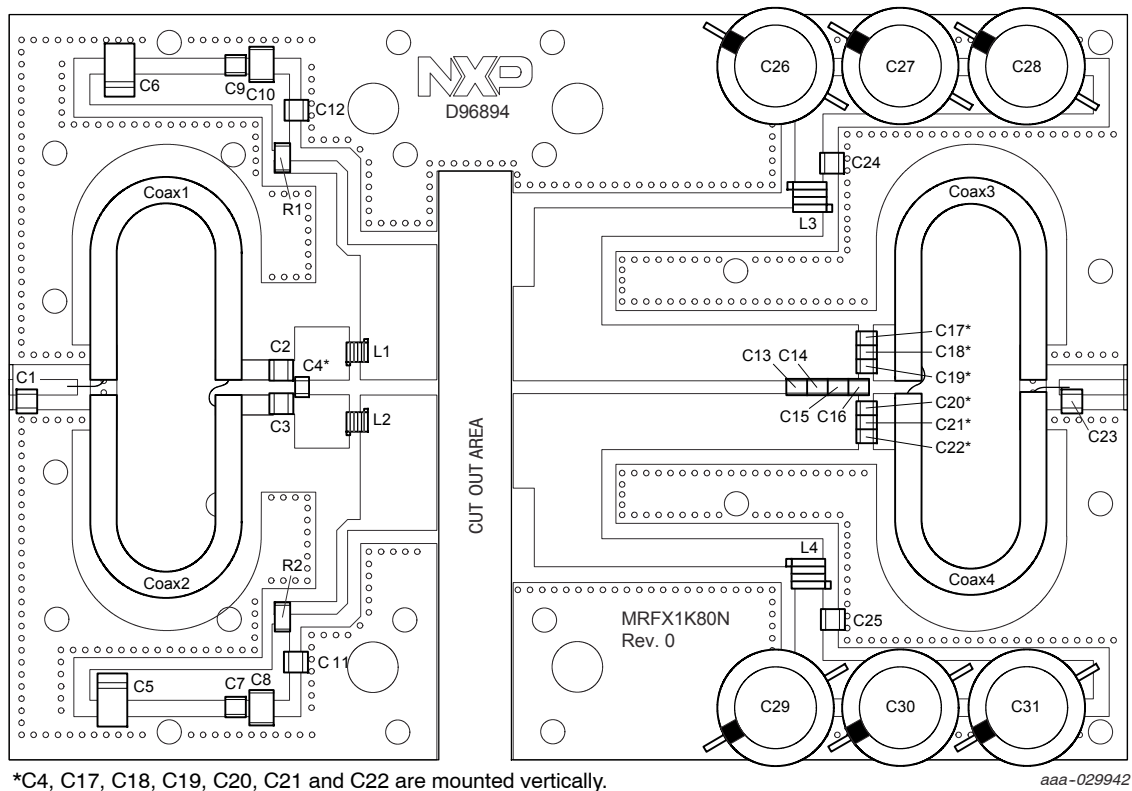

**Figure 11. MRFX1K80N Narrowband Production Test Fixture Component Layout – 230 MHz**

**Table 10. MRFX1K80N Narrowband Production Test Fixture Component Designations and Values – 230 MHz**

| Part                         | Description   | Part Number           | Manufacturer |
|------------------------------|---|-----------------------|--------------|
| C1, C2, C3                   | 22 pF Chip Capacitor                                  | ATC100B220JT500XT     | ATC          |
| C4                           | 27 pF Chip Capacitor                                  | ATC100B270JT500XT     | ATC          |
| C5, C6                       | 22 $\mu$ F, 35 V Tantalum Capacitor                   | T491X226K035AT        | Kemet        |
| C7, C9                       | 0.1 $\mu$ F Chip Capacitor                            | CDR33BX104AKWS        | AVX          |
| C8, C10                      | 220 nF Chip Capacitor                                 | C1812C224K5RACTU      | Kemet        |
| C11, C12, C24, C25           | 1000 pF Chip Capacitor                                | ATC100B102JT50XT      | ATC          |
| C13                          | 24 pF Chip Capacitor                                  | ATC800R240JT500XT     | ATC          |
| C14, C15                     | 20 pF Chip Capacitor                                  | ATC800R200JT500XT     | ATC          |
| C16                          | 22 pF Chip Capacitor                                  | ATC800R220JT500XT     | ATC          |
| C17, C18, C19, C20, C21, C22 | 240 pF Chip Capacitor                                 | ATC100B241JT200XT     | ATC          |
| C23                          | 8.2 pF Chip Capacitor                                 | ATC100B8R2CT500XT     | ATC          |
| C26, C27, C28, C29, C30, C31 | 470 $\mu$ F, 100 V Electrolytic Capacitor             | MCGPR100V477M16X32-RH | Multicomp    |
| Coax1, 2, 3, 4               | 25 $\Omega$ Semi Rigid Coax Cable, 2.2" Shield Length | UT-141C-25            | Micro-Coax   |
| L1, L2                       | 5 nH Inductor, 2 Turns                                | A02TKLC               | Coilcraft    |
| L3, L4                       | 6.6 nH Inductor, 2 Turns                              | GA3093-ALC            | Coilcraft    |
| R1, R2                       | 10 $\Omega$ , 1/4 W Chip Resistor                     | CRCW120610R0JNEA      | Vishay       |
| PCB                          | Rogers AD255A 0.030", $\epsilon_r = 2.55$             | D96894                | MTL          |

**TYPICAL CHARACTERISTICS — 230 MHz,  $T_C = 25^\circ\text{C}$   
NARROWBAND PRODUCTION TEST FIXTURE**



**Figure 12. Output Power versus Gate-Source Voltage at a Constant Input Power**

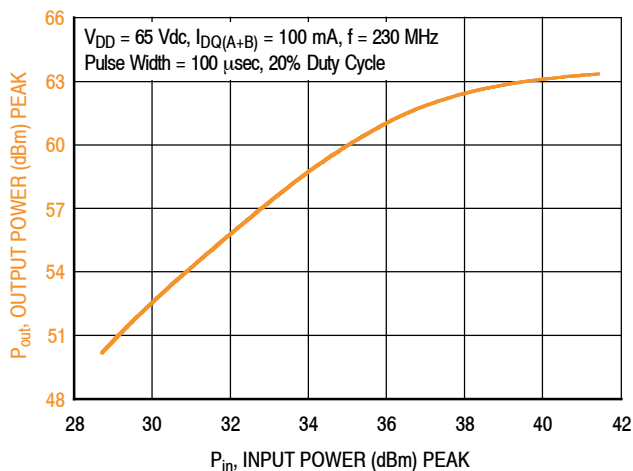

| f (MHz) | P1dB (W) | P3dB (W) |
|---------|----------|----------|
| 230     | 1878     | 2143     |

**Figure 13. Output Power versus Input Power**



**Figure 14. Power Gain and Drain Efficiency versus Output Power and Quiescent Current**

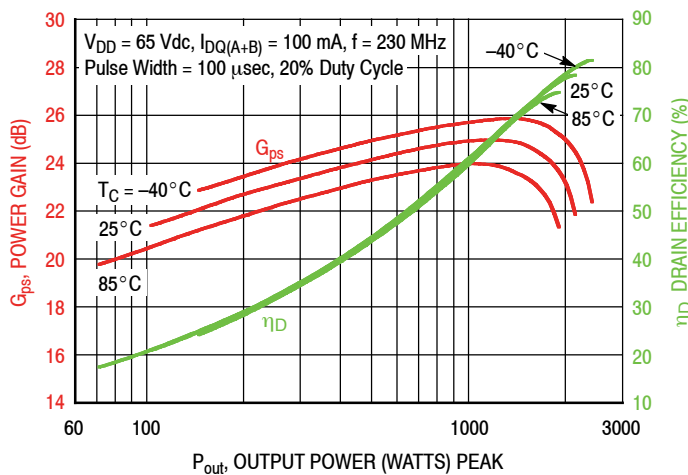

**Figure 15. Power Gain and Drain Efficiency versus Output Power**



**Figure 16. Power Gain versus Output Power and Drain-Source Voltage**

## 230 MHz NARROWBAND PRODUCTION TEST FIXTURE

| f<br>MHz | Z <sub>source</sub><br>Ω | Z <sub>load</sub><br>Ω |
|----------|--------------------------|------------------------|
| 230      | 0.9 + j2.3               | 1.9 + j2.5             |

Z<sub>source</sub> = Test fixture impedance as measured from gate to gate, balanced configuration.

Z<sub>load</sub> = Test fixture impedance as measured from drain to drain, balanced configuration.

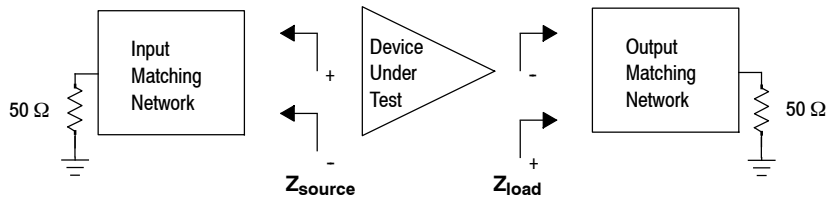

Figure 17. Narrowband Series Equivalent Source and Load Impedance – 230 MHz

# PACKAGE DIMENSIONS



|  |                          |                            |
|--|--------------------------|----------------------------|
| © NXP SEMICONDUCTORS N.V.<br>ALL RIGHTS RESERVED | MECHANICAL OUTLINE       | PRINT VERSION NOT TO SCALE |
| TITLE:<br><br>OM-1230-4L                         | DOCUMENT NO: 98ASA00506D | REV: C                     |
|  | STANDARD: NON-JEDEC      |                            |
|  | SOT1816-1                | 08 FEB 2016                |



PIN 5

BOTTOM VIEW  
 VIEW G-G

|  |                          |                            |        |
|--|--------------------------|----------------------------|--------|
| © NXP SEMICONDUCTORS N.V.<br>ALL RIGHTS RESERVED | MECHANICAL OUTLINE       | PRINT VERSION NOT TO SCALE |        |
| TITLE:<br><br>OM-1230-4L                         | DOCUMENT NO: 98ASA00506D |                            | REV: C |
|  | STANDARD: NON-JEDEC      |                            |        |
|  | SOT1816-1                | 08 FEB 2016                |        |

NOTES:

1. CONTROLLING DIMENSION: INCH
2. INTERPRET DIMENSIONS AND TOLERANCES PER ASME Y14.5M-1994.
3. DATUM PLANE H IS LOCATED AT TOP OF LEAD AND IS COINCIDENT WITH THE LEAD WHERE THE LEAD EXITS THE PLASTIC BODY AT THE TOP OF THE PARTING LINE.
4. DIMENSIONS DD AND E1 DO NOT INCLUDE MOLD PROTRUSION. ALLOWABLE PROTRUSION IS .006 INCH (0.15 MM) PER SIDE. DIMENSIONS DD AND E1 DO INCLUDE MOLD MISMATCH AND ARE DETERMINED AT DATUM PLANE H.
5. DIMENSION bb DOES NOT INCLUDE DAMBAR PROTRUSION. ALLOWABLE DAMBAR PROTRUSION SHALL BE .005 INCH (0.13 MM) TOTAL IN EXCESS OF THE bb DIMENSION AT MAXIMUM MATERIAL CONDITION.
6. DATUMS A AND B TO BE DETERMINED AT DATUM PLANE H.
7. DIMENSION A1 APPLIES WITHIN ZONE J ONLY.
8. HATCHING REPRESENTS THE EXPOSED AREA OF THE HEAT SLUG. THE DIMENSIONS D1 AND E2 REPRESENT THE VALUES BETWEEN THE TWO OPPOSITE POINTS ALONG THE EDGES OF EXPOSED AREA OF HEAT SLUG.
9. DIMPLED HOLE REPRESENTS INPUT SIDE.

| DIM  | INCH     |       | MILLIMETER         |       | DIM                                  | INCH                       |      | MILLIMETER |       |
|--|----------|-------|--------------------|-------|--------------------------------------|----------------------------|------|------------|-------|
|  | MIN      | MAX   | MIN                | MAX   |                                      | MIN                        | MAX  | MIN        | MAX   |
| AA   | .148     | .152  | 3.76               | 3.86  | bb                                   | .457                       | .463 | 11.61      | 11.76 |
| A1   | .059     | .065  | 1.50               | 1.65  | c1                                   | .007                       | .011 | 0.18       | 0.28  |
| DD   | 1.267    | 1.273 | 32.18              | 32.33 | e                                    | .270 BSC                   |      | 6.86 BSC   |       |
| D1   | 1.180    | ----  | 29.97              | ----  | e1                                   | .116                       | .124 | 2.95       | 3.15  |
| E  | .762     | .770  | 19.35              | 19.56 |                                      |                            |      |            |       |
| E1   | .390     | .394  | 9.91               | 10.01 | aaa                                  | .004                       |      | 0.10       |       |
| E2   | .306     | ----  | 7.77               | ----  | bbb                                  | .006                       |      | 0.15       |       |
| E3   | .383     | .387  | 9.73               | 9.83  | ccc                                  | .010                       |      | 0.25       |       |
| F  | .025 BSC |       | 0.635 BSC          |       |                                      |                            |      |            |       |
| © NXP SEMICONDUCTORS N.V.<br>ALL RIGHTS RESERVED |          |       | MECHANICAL OUTLINE |       |                                      | PRINT VERSION NOT TO SCALE |      |            |       |
| TITLE:<br><br>OM-1230-4L                         |          |       |                    |       | DOCUMENT NO: 98ASA00506D      REV: C |                            |      |            |       |
|  |          |       |                    |       | STANDARD: NON-JEDEC                  |                            |      |            |       |
|  |          |       |                    |       | SOT1816-1      08 FEB 2016           |                            |      |            |       |





|  |                          |                            |
|--|--------------------------|----------------------------|
| © NXP SEMICONDUCTORS N.V.<br>ALL RIGHTS RESERVED | MECHANICAL OUTLINE       | PRINT VERSION NOT TO SCALE |
| TITLE:<br><br>OM-1230G-4L                        | DOCUMENT NO: 98ASA00818D | REV: B                     |
|  | STANDARD: NON-JEDEC      |                            |
|  | SOT1824-1                | 18 FEB 2016                |

MRFX1K80N MRFX1K80GN



|  |                          |                            |
|--|--------------------------|----------------------------|
| © NXP SEMICONDUCTORS N.V.<br>ALL RIGHTS RESERVED | MECHANICAL OUTLINE       | PRINT VERSION NOT TO SCALE |
| TITLE:<br><br>OM-1230G-4L                        | DOCUMENT NO: 98ASA00818D | REV: B                     |
|  | STANDARD: NON-JEDEC      |                            |
|  | SOT1824-1                | 18 FEB 2016                |

NOTES:

1. CONTROLLING DIMENSION: INCH
2. INTERPRET DIMENSIONS AND TOLERANCES PER ASME Y14.5M-1994.
3. DATUM PLANE H IS LOCATED AT TOP OF LEAD AND IS COINCIDENT WITH THE LEAD WHERE THE LEAD EXITS THE PLASTIC BODY AT THE TOP OF THE PARTING LINE.
4. DIMENSIONS DD AND E1 DO NOT INCLUDE MOLD PROTRUSION. ALLOWABLE PROTRUSION IS .006 INCH (0.15 MM) PER SIDE. DIMENSIONS DD AND E1 DO INCLUDE MOLD MISMATCH AND ARE DETERMINED AT DATUM PLANE H.
5. DIMENSION bb DOES NOT INCLUDE DAMBAR PROTRUSION. ALLOWABLE DAMBAR PROTRUSION SHALL BE .005 INCH (0.13 MM) TOTAL IN EXCESS OF THE bb DIMENSION AT MAXIMUM MATERIAL CONDITION.
6. DATUMS A AND B TO BE DETERMINED AT DATUM PLANE H.
7. HATCHING REPRESENTS THE EXPOSED AND SOLDERABLE AREA OF THE HEAT SLUG. THE DIMENSIONS D1 AND E2 REPRESENT THE VALUES BETWEEN THE TWO OPPOSITE POINTS ALONG THE EDGES OF EXPOSED AREA OF HEAT SLUG.
8. DIMPLED HOLE REPRESENTS INPUT SIDE.
9. DIMENSION A1 IS MEASURED WITH REFERENCE TO DATUM D. THE POSITIVE VALUE IMPLIES THAT THE BOTTOM OF THE PACKAGE IS HIGHER THAN THE BOTTOM OF THE LEAD.

| DIM | INCH     |       | MILLIMETER |       | DIM | INCH     |      | MILLIMETER |       |
|-----|----------|-------|------------|-------|-----|----------|------|------------|-------|
|     | MIN      | MAX   | MIN        | MAX   |     | MIN      | MAX  | MIN        | MAX   |
| AA  | .148     | .152  | 3.76       | 3.86  | bb  | .457     | .463 | 11.61      | 11.76 |
| A1  | -.003    | .003  | -0.08      | 0.08  | c1  | .007     | .011 | 0.18       | 0.28  |
| DD  | 1.267    | 1.273 | 32.18      | 32.33 | e   | .270 BSC |      | 6.86 BSC   |       |
| D1  | 1.180    | ----  | 29.97      | ----  | e1  | .116     | .124 | 2.95       | 3.15  |
| E   | .563     | .575  | 14.30      | 14.61 | θ   | 0°       | 8°   | 0°         | 8°    |
| E1  | .390     | .394  | 9.91       | 10.01 | aaa | .004     |      | 0.10       |       |
| E2  | .306     | ----  | 7.77       | ----  | bbb | .006     |      | 0.15       |       |
| E3  | .383     | .387  | 9.73       | 9.83  | ccc | .010     |      | 0.25       |       |
| L   | .034     | .046  | 0.86       | 1.17  |     |          |      |            |       |
| L1  | .010 BSC |       | 0.25 BSC   |       |     |          |      |            |       |

|  |  |                    |                          |                            |             |  |  |
|--|--|--------------------|--------------------------|----------------------------|-------------|--|--|
| © NXP SEMICONDUCTORS N.V.<br>ALL RIGHTS RESERVED |  | MECHANICAL OUTLINE |                          | PRINT VERSION NOT TO SCALE |             |  |  |
| TITLE:<br><br>OM-1230G-4L                        |  |                    | DOCUMENT NO: 98ASA00818D |                            | REV: B      |  |  |
|  |  |                    | STANDARD: NON-JEDEC      |                            |             |  |  |
|  |  |                    | SOT1824-1                |                            | 18 FEB 2016 |  |  |

## PRODUCT DOCUMENTATION, SOFTWARE AND TOOLS

Refer to the following resources to aid your design process.

### Application Notes

- AN1907: Solder Reflow Attach Method for High Power RF Devices in Over-Molded Plastic Packages
- AN1955: Thermal Measurement Methodology of RF Power Amplifiers

### Engineering Bulletins

- EB212: Using Data Sheet Impedances for RF LDMOS Devices

### Software

- Electromigration MTTF Calculator
- RF High Power Model
- .s2p File

### Development Tools

- Printed Circuit Boards

### To Download Resources Specific to a Given Part Number:

1. Go to <http://www.nxp.com/RF>
2. Search by part number
3. Click part number link
4. Choose the desired resource from the drop down menu

## REVISION HISTORY

The following table summarizes revisions to this document.

| Revision | Date      | Description                     |
|----------|-----------|---------------------------------|
| 0        | Apr. 2018 | • Initial release of data sheet |

## ***How to Reach Us:***

**Home Page:**  
nxp.com

**Web Support:**  
nxp.com/support

Information in this document is provided solely to enable system and software implementers to use NXP products. There are no express or implied copyright licenses granted hereunder to design or fabricate any integrated circuits based on the information in this document. NXP reserves the right to make changes without further notice to any products herein.

NXP makes no warranty, representation, or guarantee regarding the suitability of its products for any particular purpose, nor does NXP assume any liability arising out of the application or use of any product or circuit, and specifically disclaims any and all liability, including without limitation consequential or incidental damages. "Typical" parameters that may be provided in NXP data sheets and/or specifications can and do vary in different applications, and actual performance may vary over time. All operating parameters, including "typicals," must be validated for each customer application by customer's technical experts. NXP does not convey any license under its patent rights nor the rights of others. NXP sells products pursuant to standard terms and conditions of sale, which can be found at the following address: [nxp.com/SalesTermsandConditions](http://nxp.com/SalesTermsandConditions).

NXP and the NXP logo are trademarks of NXP B.V. All other product or service names are the property of their respective owners.

© 2018 NXP B.V.



# Mouser Electronics

Authorized Distributor

Click to View Pricing, Inventory, Delivery & Lifecycle Information:

[NXP:](#)

[MRFX1K80NR5](#) [MRFX1K80GNR5](#) [MRFX1K80N-230MHZ](#) [MRFX1K80N-88MHZ](#)