

RF Power LDMOS Transistor

High Ruggedness N-Channel Enhancement-Mode Lateral MOSFET

This high ruggedness device is designed for use in high VSWR industrial, scientific and medical applications, as well as radio and VHF TV broadcast, sub-GHz aerospace and mobile radio applications. Its unmatched input and output design allows for wide frequency range use from 1.8 to 500 MHz.

Typical Performance: $V_{DD} = 50$ Vdc

Frequency (MHz)	Signal Type	P_{out} (W)	G_{ps} (dB)	η_D (%)
27	CW	1550 CW	25.9	78.3
81.36 (1)	CW	1400 CW	23.0	75.0
87.5–108 (2,3)	CW	1475 CW	23.3	83.4
230 (4)	Pulse (100 μ sec, 20% Duty Cycle)	1500 Peak	23.7	74.0

Load Mismatch/Ruggedness

Frequency (MHz)	Signal Type	VSWR	P_{in} (W)	Test Voltage	Result
230 (4)	Pulse (100 μ sec, 20% Duty Cycle)	> 65:1 at all Phase Angles	13 Peak (3 dB Overdrive)	50	No Device Degradation

1. Data from 81.36 MHz narrowband reference circuit (page 11).
2. Data from 87.5–108 MHz broadband reference circuit (page 5).
3. The values shown are the center band performance numbers across the indicated frequency range.
4. Data from 230 MHz narrowband production test fixture (page 16).

Features

- High drain-source avalanche energy absorption capability
- Unmatched input and output allowing wide frequency range utilization
- Device can be used single-ended or in a push-pull configuration
- Characterized from 30 to 50 V for ease of use
- Suitable for linear application
- Integrated ESD protection with greater negative gate-source voltage range for improved Class C operation
- Recommended driver: MRFE6VS25N (25 W)
- Lower thermal resistance part available: MRF1K50N
- Included in NXP product longevity program with assured supply for a minimum of 15 years after launch

Typical Applications

- Industrial, scientific, medical (ISM)
 - Laser generation
 - Plasma etching
 - Particle accelerators
 - MRI and other medical applications
 - Industrial heating, welding and drying systems
- Broadcast
 - Radio broadcast
 - VHF TV broadcast
- Aerospace
 - VHF omnidirectional range (VOR)
 - HF and VHF communications
 - Weather radar
- Mobile radio
 - VHF and UHF base stations

MRF1K50H

1.8–500 MHz, 1500 W CW, 50 V
WIDEBAND
RF POWER LDMOS TRANSISTOR



NI-1230H-4S

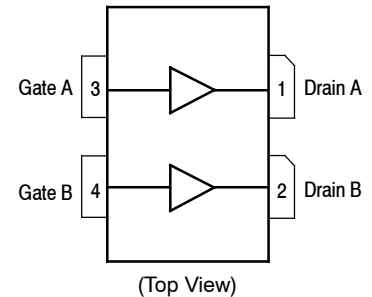

Note: The backside of the package is the source terminal for the transistor.

Figure 1. Pin Connections

Table 1. Maximum Ratings

Rating	Symbol	Value	Unit
Drain-Source Voltage	V_{DSS}	-0.5, +135	Vdc
Gate-Source Voltage	V_{GS}	-6.0, +10	Vdc
Operating Voltage	V_{DD}	50	Vdc
Storage Temperature Range	T_{stg}	-65 to +150	°C
Case Operating Temperature Range	T_C	-40 to +150	°C
Operating Junction Temperature Range (1,2)	T_J	-40 to +225	°C
Total Device Dissipation @ $T_C = 25^\circ\text{C}$ Derate above 25°C	P_D	1667 8.33	W W/°C

Table 2. Thermal Characteristics

Characteristic	Symbol	Value (2,3)	Unit
Thermal Resistance, Junction to Case CW: Case Temperature 78°C, 1500 W CW, 50 Vdc, $I_{DQ(A+B)} = 200$ mA, 88 MHz	$R_{\theta JC}$	0.10	°C/W
Thermal Impedance, Junction to Case Pulse: Case Temperature 73°C, 1500 W Peak, 100 μsec Pulse Width, 20% Duty Cycle, $I_{DQ(A+B)} = 100$ mA, 230 MHz	$Z_{\theta JC}$	0.028	°C/W

Table 3. ESD Protection Characteristics

Test Methodology	Class
Human Body Model (per JESD22-A114)	2, passes 2500 V
Machine Model (per EIA/JESD22-A115)	B, passes 250 V
Charge Device Model (per JESD22-C101)	IV, passes 2000 V

Table 4. Electrical Characteristics ($T_A = 25^\circ\text{C}$ unless otherwise noted)

Characteristic	Symbol	Min	Typ	Max	Unit
----------------	--------	-----	-----	-----	------

Off Characteristics (4)

Gate-Source Leakage Current ($V_{GS} = 5$ Vdc, $V_{DS} = 0$ Vdc)	I_{GSS}	—	—	1	μAdc
Drain-Source Breakdown Voltage ($V_{GS} = 0$ Vdc, $I_D = 30$ μAdc)	$V_{(BR)DSS}$	135	—	—	Vdc
Zero Gate Voltage Drain Leakage Current ($V_{DS} = 50$ Vdc, $V_{GS} = 0$ Vdc)	I_{DSS}	—	—	10	μAdc
Zero Gate Voltage Drain Leakage Current ($V_{DS} = 100$ Vdc, $V_{GS} = 0$ Vdc)	I_{DSS}	—	—	20	μAdc

On Characteristics

Gate Threshold Voltage (4) ($V_{DS} = 10$ Vdc, $I_D = 2130$ μAdc)	$V_{GS(th)}$	1.7	2.2	2.7	Vdc
Gate Quiescent Voltage ($V_{DD} = 50$ Vdc, $I_{D(A+B)} = 100$ mAdc, Measured in Functional Test)	$V_{GS(Q)}$	1.9	2.4	2.9	Vdc
Drain-Source On-Voltage (4) ($V_{GS} = 10$ Vdc, $I_D = 2.4$ Adc)	$V_{DS(on)}$	—	0.15	—	Vdc
Forward Transconductance (4) ($V_{DS} = 10$ Vdc, $I_D = 36$ Adc)	g_{fs}	—	33.5	—	S

1. Continuous use at maximum temperature will affect MTTF.
2. MTTF calculator available at <http://www.nxp.com/RF/calculators>.
3. Refer to AN1955, *Thermal Measurement Methodology of RF Power Amplifiers*. Go to <http://www.nxp.com/RF> and search for AN1955.
4. Each side of device measured separately.

(continued)

Table 4. Electrical Characteristics ($T_A = 25^\circ\text{C}$ unless otherwise noted) (continued)

Characteristic	Symbol	Min	Typ	Max	Unit
Dynamic Characteristics ⁽¹⁾					
Reverse Transfer Capacitance ($V_{DS} = 50\text{ Vdc} \pm 30\text{ mV(rms)ac}$ @ 1 MHz, $V_{GS} = 0\text{ Vdc}$)	C_{rss}	—	3.48	—	pF
Output Capacitance ($V_{DS} = 50\text{ Vdc} \pm 30\text{ mV(rms)ac}$ @ 1 MHz, $V_{GS} = 0\text{ Vdc}$)	C_{oss}	—	205	—	pF
Input Capacitance ($V_{DS} = 50\text{ Vdc}$, $V_{GS} = 0\text{ Vdc} \pm 30\text{ mV(rms)ac}$ @ 1 MHz)	C_{iss}	—	664	—	pF

Functional Tests (In NXP Production Test Fixture, 50 ohm system) $V_{DD} = 50\text{ Vdc}$, $I_{DQ(A+B)} = 100\text{ mA}$, $P_{out} = 1500\text{ W Peak}$ (300 W Avg.), $f = 230\text{ MHz}$, 100 μsec Pulse Width, 20% Duty Cycle

Power Gain	G_{ps}	22.5	23.7	25.5	dB
Drain Efficiency	η_D	70.0	74.0	—	%
Input Return Loss	IRL	—	-18.3	-9	dB

Table 5. Load Mismatch/Ruggedness (In NXP Production Test Fixture, 50 ohm system) $I_{DQ(A+B)} = 100\text{ mA}$

Frequency (MHz)	Signal Type	VSWR	P_{in} (W)	Test Voltage, V_{DD}	Result
230	Pulse (100 μsec , 20% Duty Cycle)	> 65:1 at all Phase Angles	13 Peak (3 dB Overdrive)	50	No Device Degradation

Table 6. Ordering Information

Device	Tape and Reel Information	Package
MRF1K50HR5	R5 Suffix = 50 Units, 56 mm Tape Width, 13-inch Reel	NI-1230H-4S

1. Each side of device measured separately.

TYPICAL CHARACTERISTICS

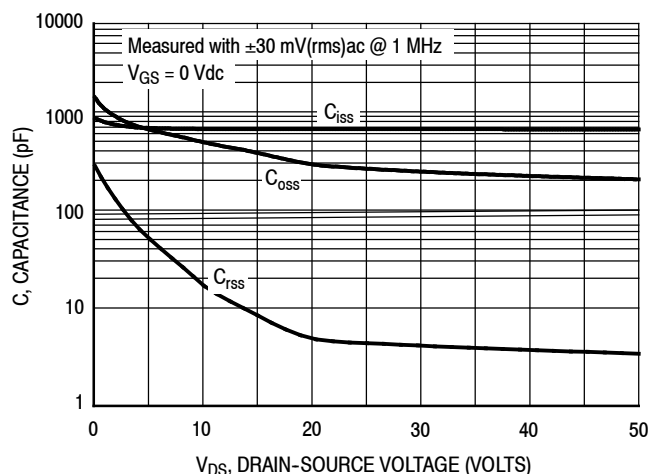

Note: Each side of device measured separately.

Figure 2. Capacitance versus Drain-Source Voltage

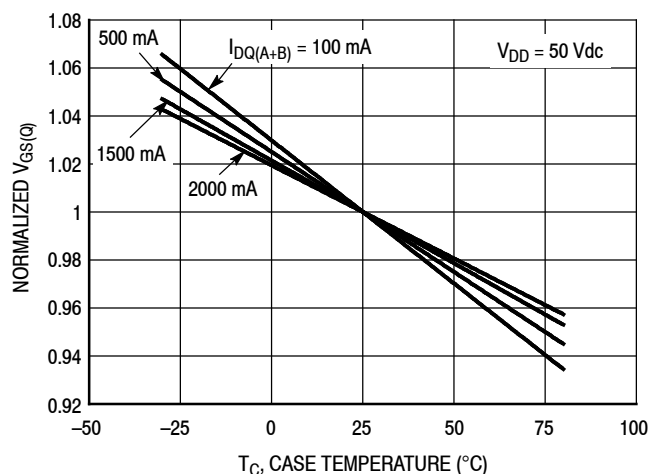

I_{DQ} (mA)	Slope (mV/°C)
100	-2.87
500	-2.56
1500	-2.29
2000	-2.11

Figure 3. Normalized V_{GS} versus Quiescent Current and Case Temperature

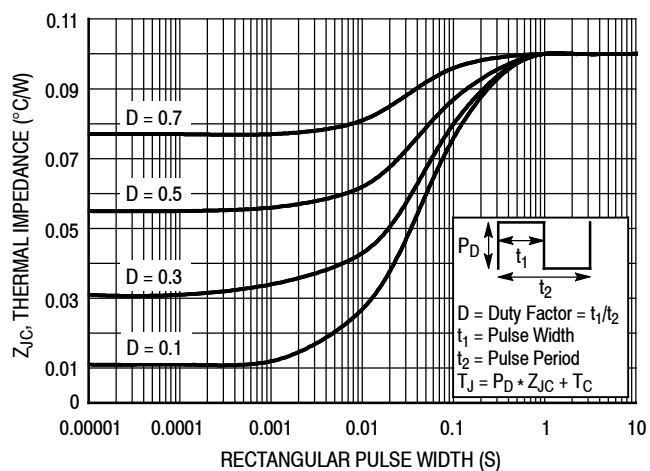
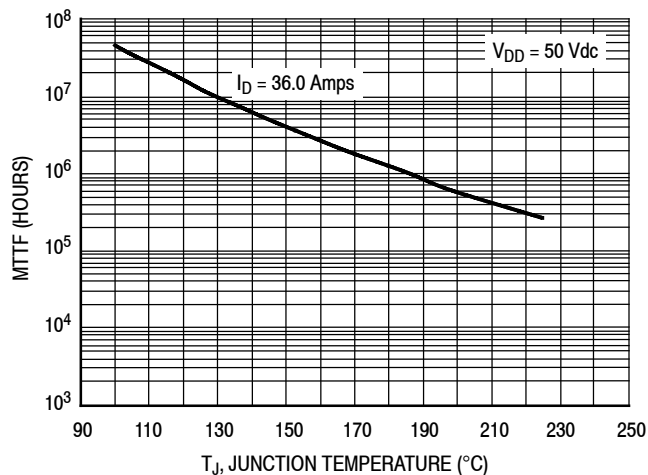

Figure 4. Maximum Transient Thermal Impedance



Note: MTTF value represents the total cumulative operating time under indicated test conditions.

MTTF calculator available at <http://www.nxp.com/RF/calculators>.

Figure 5. MTTF versus Junction Temperature — CW

87.5–108 MHz BROADBAND REFERENCE CIRCUIT

Table 7. 87.5–108 MHz Broadband Performance (In NXP Reference Circuit, 50 ohm system)

$V_{DD} = 50$ Vdc, $I_{DQ(A+B)} = 200$ mA, $P_{in} = 7$ W, CW

Frequency (MHz)	G_{ps} (dB)	η_D (%)	P_{out} (W)
87.5	22.8	81.8	1325
98	23.3	83.4	1475
108	23.0	81.2	1410

87.5–108 MHz BROADBAND REFERENCE CIRCUIT — 2.88" x 5.12" (73 mm x 130 mm)

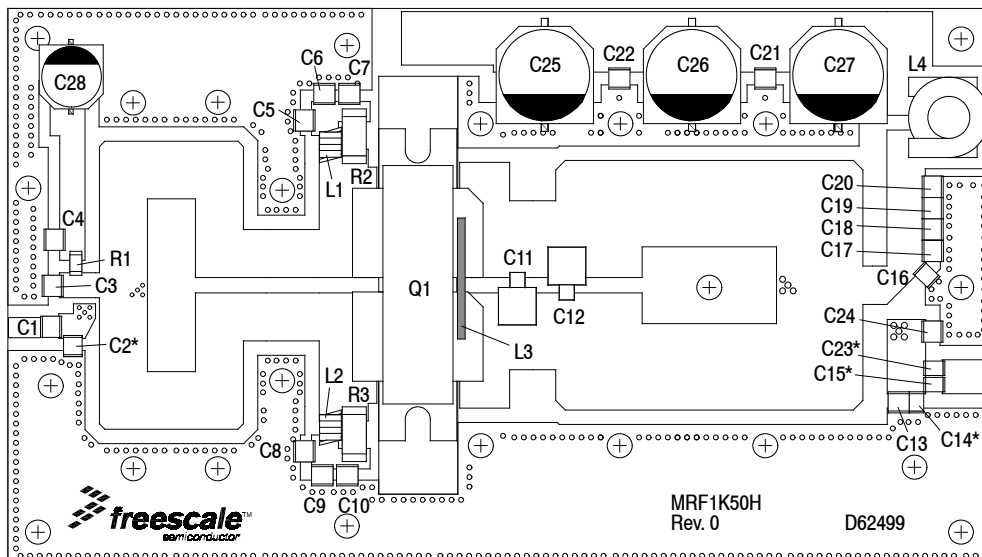

*C2, C14, C15 and C23 are mounted vertically.
 Note: Q1 leads are soldered to the PCB with L3 soldered directly on top of the drain leads.

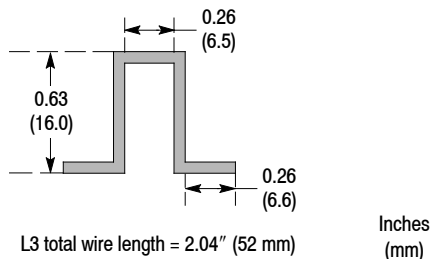

Figure 6. MRF1K50H 87.5–108 MHz Broadband Reference Circuit Component Layout

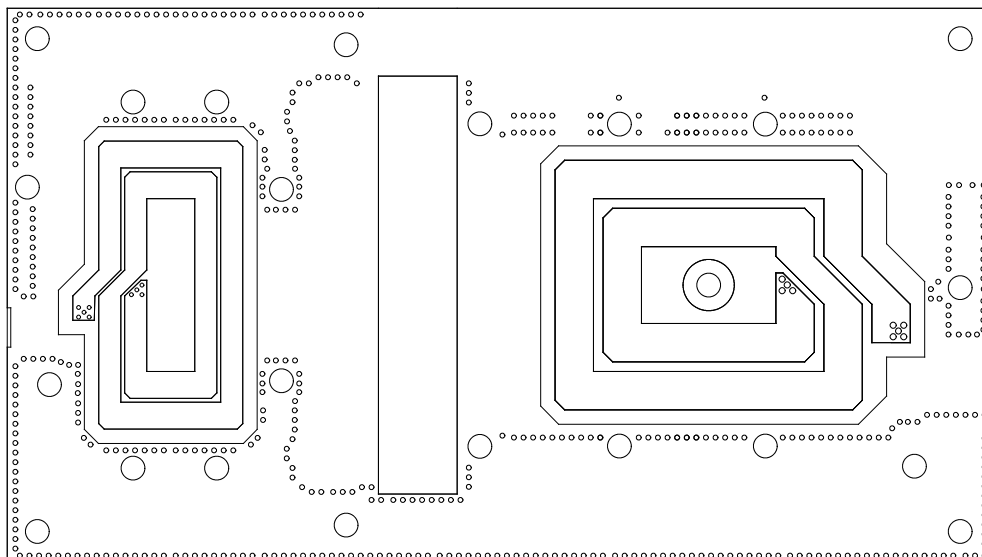

Figure 7. MRF1K50H 87.5–108 MHz Broadband Reference Circuit Component Layout — Bottom

87.5–108 MHz BROADBAND REFERENCE CIRCUIT

Table 8. MRF1K50H Broadband Reference Circuit Component Designations and Values — 87.5–108 MHz

Part	Description	Part Number	Manufacturer
C1, C3, C6, C9, C18, C19, C20, C21, C22	1000 pF Chip Capacitors	ATC100B102JT50XT	ATC
C2	33 pF Chip Capacitor	ATC100B330JT500XT	ATC
C4, C5, C8	10,000 pF Chip Capacitors	ATC200B103KT50XT	ATC
C7, C10, C15, C16, C17, C23	470 pF Chip Capacitors	ATC100B471JT200XT	ATC
C11	91 pF 300 V Mica Capacitor	MIN02-002EC910J-F	CDE
C12	56 pF 300 V Mica Capacitor	MIN02-002DC560J-F	CDE
C13	2.2 pF Chip Capacitor	ATC100B2R2JT500XT	ATC
C14, C24	12 pF Chip Capacitors	ATC100B120GT500XT	ATC
C25, C26, C27	220 μ F, 63 V Electrolytic Capacitors	EEV-FK2A221M	Panasonic
C28	22 μ F, 35 V Electrolytic Capacitor	UUD1V220MCL1GS	Nichicon
L1, L2	17.5 nH Inductors, 6 Turns	B06TJLC	Coilcraft
L3	1.5 mm Non-Tarnish Silver Plated Copper Wire	SP1500NT-001	Scientific Wire Company
L4	22 nH Inductor	1212VS-22NMEB	Coilcraft
Q1	RF Power LDMOS Transistor	MRF1K50H	NXP
R1	10 Ω , 1/4 W Chip Resistor	CRCW120610R0JNEA	Vishay
R2, R3	33 Ω , 2 W Chip Resistors	1-2176070-3	TE Connectivity
PCB	Arlon TC350 0.030", $\epsilon_r = 3.5$	D62499	MTL

Note: Refer to MRF1K50H's [printed circuit boards and schematics](#) to download the 87.5–108 MHz heatsink drawing.

**TYPICAL CHARACTERISTICS — 87.5–108 MHz
BROADBAND REFERENCE CIRCUIT**

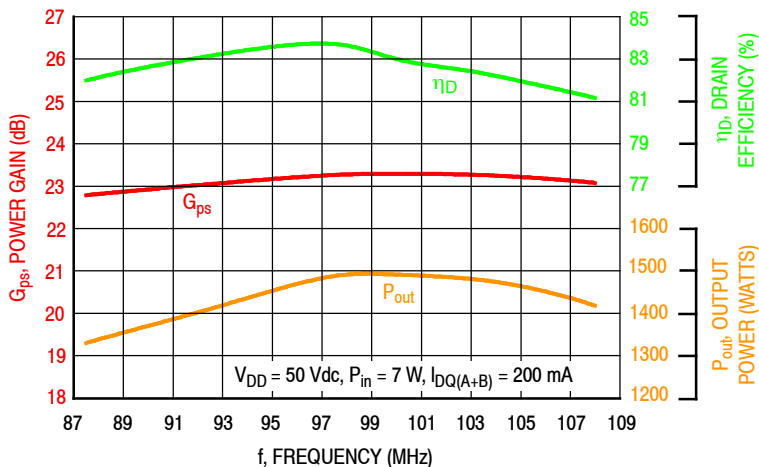

Figure 8. Power Gain, Drain Efficiency and CW Output Power versus Frequency at a Constant Input Power

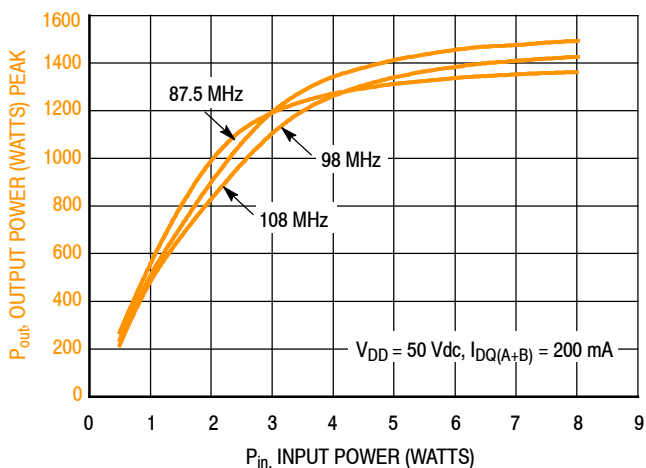

Figure 9. CW Output Power versus Input Power and Frequency

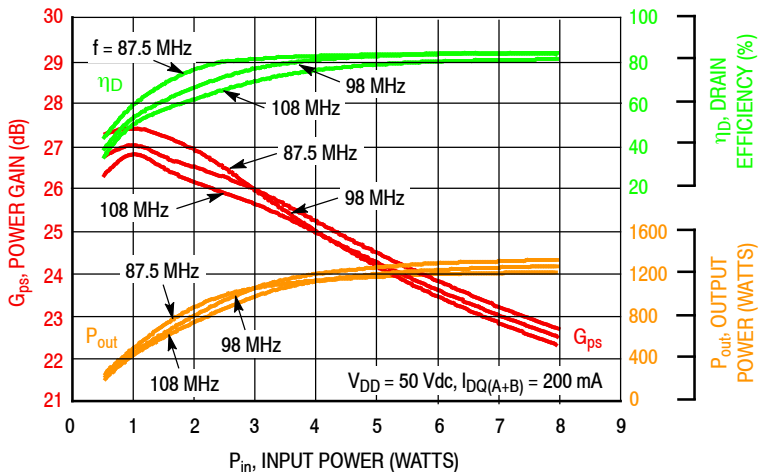
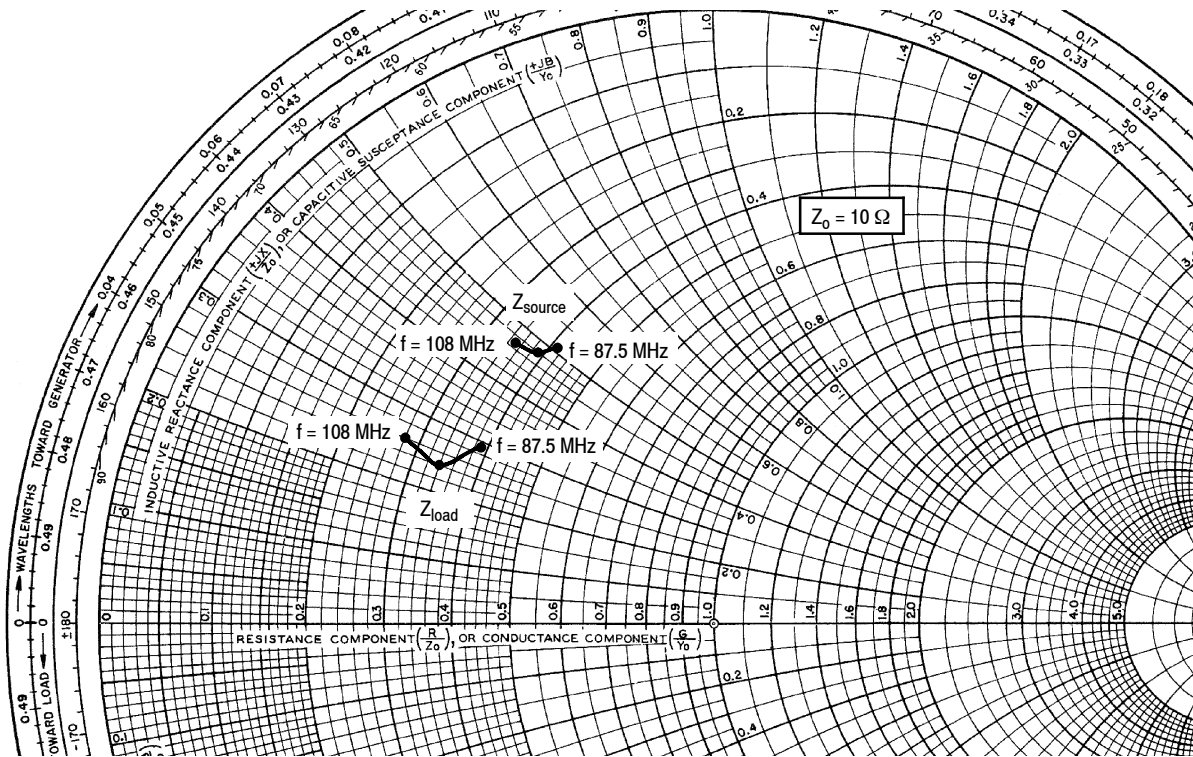

Figure 10. Power Gain, Drain Efficiency and CW Output Power versus Input Power and Frequency

87.5–108 MHz BROADBAND REFERENCE CIRCUIT



f MHz	Z _{source} Ω	Z _{load} Ω
87.5	4.07 + j5.13	3.92 + j2.89
98	3.93 + j4.84	3.39 + j2.35
108	3.50 + j4.72	2.83 + j2.56

Z_{source} = Test circuit impedance as measured from gate to gate, balanced configuration.

Z_{load} = Test circuit impedance as measured from drain to drain, balanced configuration.

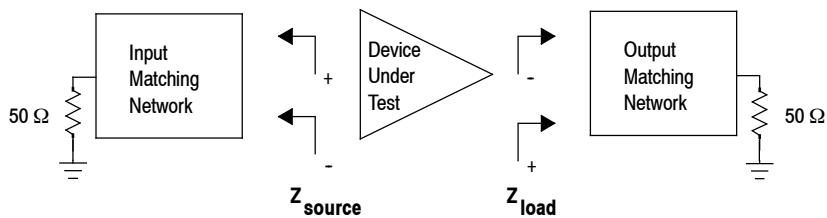
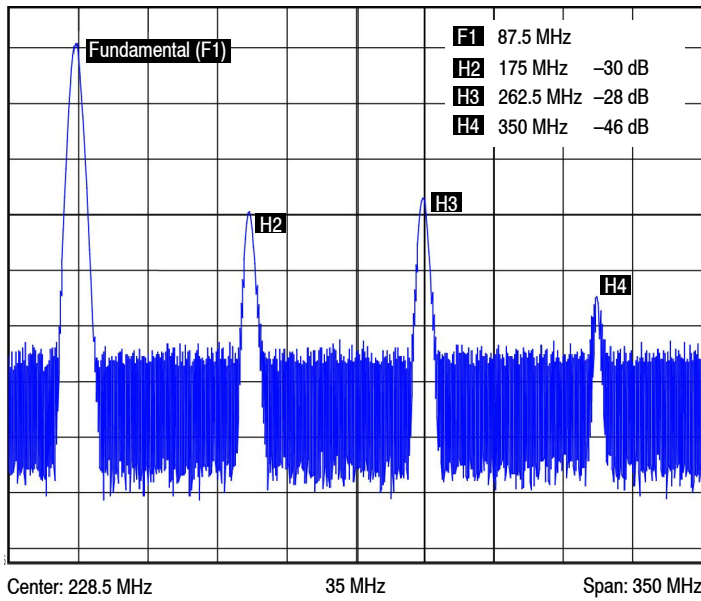

Figure 11. Broadband Series Equivalent Source and Load Impedance — 87.5–108 MHz

**HARMONIC MEASUREMENTS — 87.5–108 MHz
BROADBAND REFERENCE CIRCUIT**



H2 (175 MHz)	H3 (262.5 MHz)	H4 (350 MHz)
-30 dB	-28 dB	-46 dB

Figure 12. 87.5 MHz Harmonics @ 1200 W CW

81.36 MHz NARROWBAND REFERENCE CIRCUIT

Table 9. 81.36 MHz Narrowband Performance (In NXP Reference Circuit, 50 ohm system)

$V_{DD} = 50$ Vdc, $I_{DQ(A+B)} = 150$ mA, $P_{in} = 3$ W, CW

Frequency (MHz)	G_{ps} (dB)	η_D (%)	P_{out} (W)
81.36	23.0	75.0	1400

81.36 MHz NARROWBAND REFERENCE CIRCUIT — 2.88" × 6.38" (73.2 mm × 162 mm)

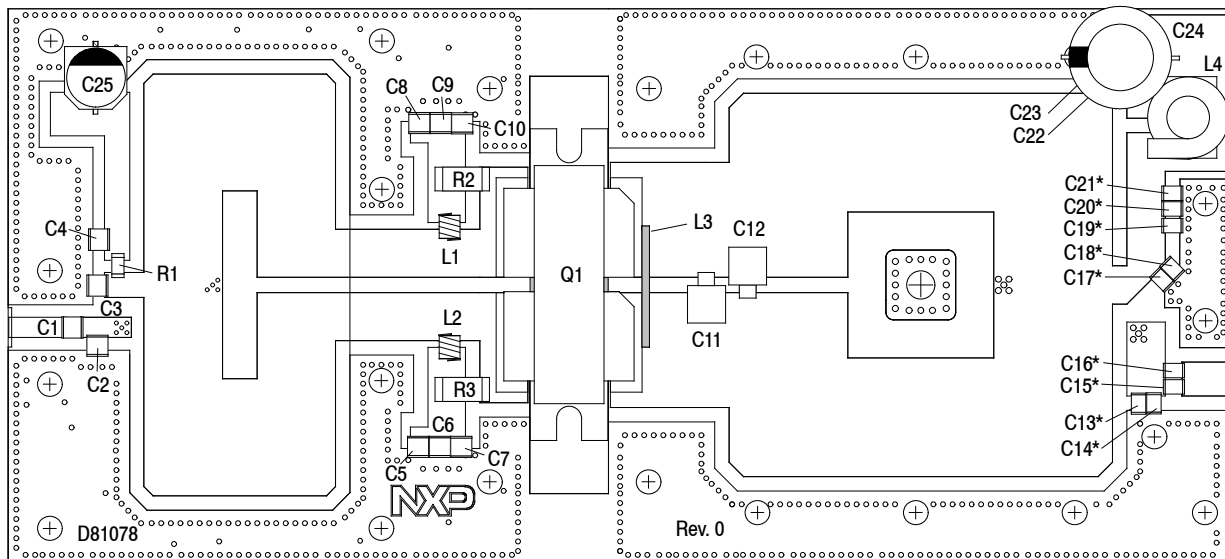

*C13, C14, C15, C16, C17, C18, C19, C20, and C21 are mounted vertically.

L3 total wire length = 1.50" (38 mm)

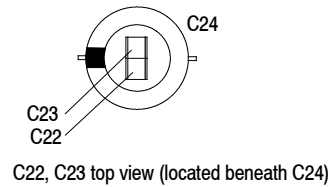
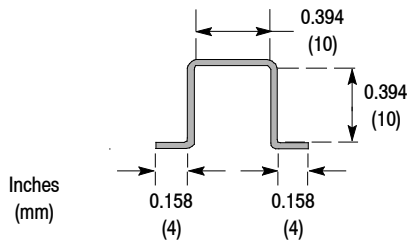

Figure 13. MRF1K50H 81.36 MHz Narrowband Reference Circuit Component Layout

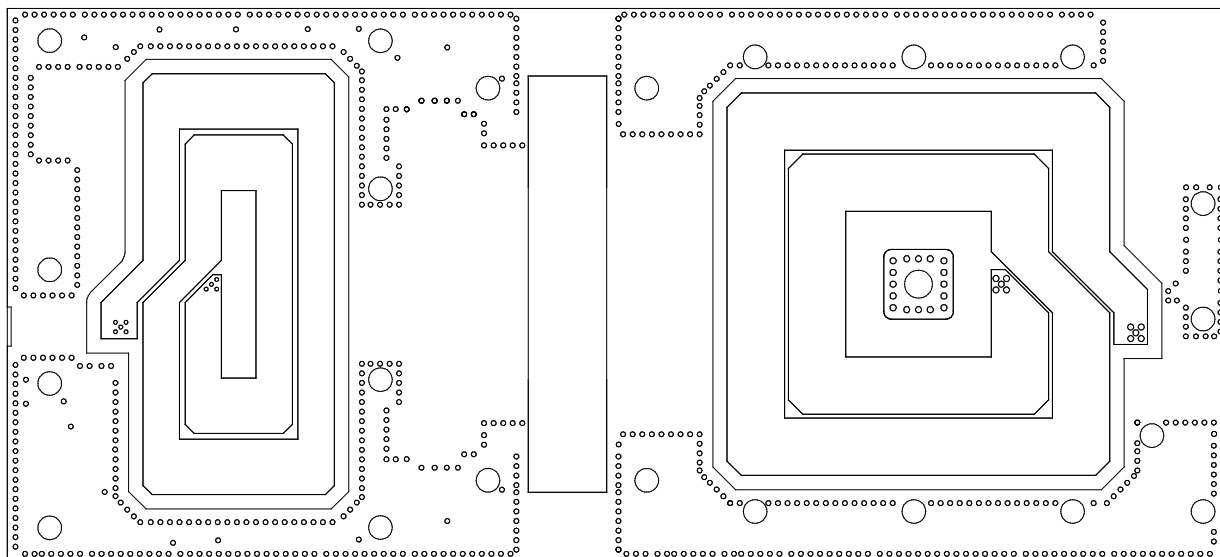

Figure 14. MRF1K50H 81.36 MHz Narrowband Reference Circuit Component Layout — Bottom

81.36 MHz NARROWBAND REFERENCE CIRCUIT

Table 10. MRF1K50H Narrowband Reference Circuit Component Designations and Values — 81.36 MHz

Part	Description	Part Number	Manufacturer
C1, C3, C6, C9, C19, C20, C21, C22	1000 pF Chip Capacitors	ATC100B102JT50XT	ATC
C2	22 pF Chip Capacitor	ATC100B220JT500XT	ATC
C4, C5, C8, C23	10,000 pF Chip Capacitors	ATC200B103KT50XT	ATC
C7, C10, C15, C16, C17, C18	470 pF Chip Capacitors	ATC100B471JT200XT	ATC
C11	62 pF 300 V Mica Capacitor	MIN02-002EC620J-F	CDE
C12	91 pF 300 V Mica Capacitor	MIN02-002EC910J-F	CDE
C13	6.8 pF Chip Capacitor	ATC100B6R8CT500XT	ATC
C14	1.5 pF Chip Capacitor	ATC100B1R5BT500XT	ATC
C24	220 μ F, 63 V Electrolytic Capacitor	EEU-FC1J221S	Panasonic
C25	22 μ F, 35 V Electrolytic Capacitor	UUD1V220MCL1GS	Nichicon
L1, L2	12.5 nH Inductors, 4 Turns	A04TJLC	Coilcraft
L3	1.5 mm Non-Tarnish Silver Plated Copper Wire	SP1500NT-001	Scientific Wire Company
L4	22 nH Inductor	1212VS-22NMEB	Coilcraft
Q1	RF Power LDMOS Transistor	MRF1K50H	NXP
R1	10 Ω , 1/4 W Chip Resistor	CRCW120610R0JNEA	Vishay
R2, R3	33 Ω , 2 W Chip Resistors	1-2176070-3	TE Connectivity
PCB	Arlon TC350 0.030", $\epsilon_r = 3.5$	D81078	MTL

Note: Refer to MRF1K50H's [printed circuit boards and schematics](#) to download the 81.36 MHz heatsink drawing.

TYPICAL CHARACTERISTICS — 81.36 MHz
NARROWBAND REFERENCE CIRCUIT

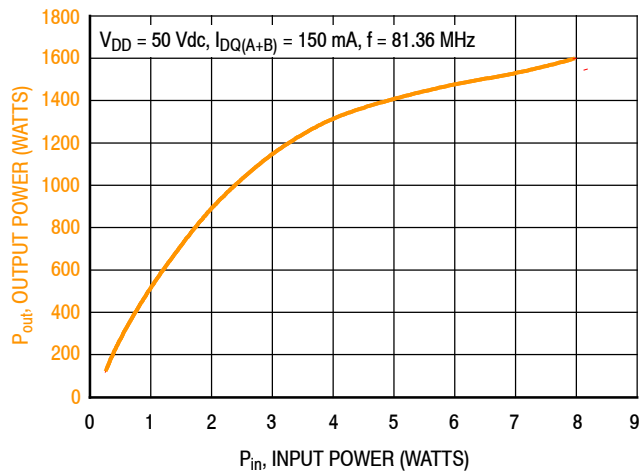

f (MHz)	P1dB (W)	P3dB (W)
81.36	890	1414

Figure 15. CW Output Power versus Input Power

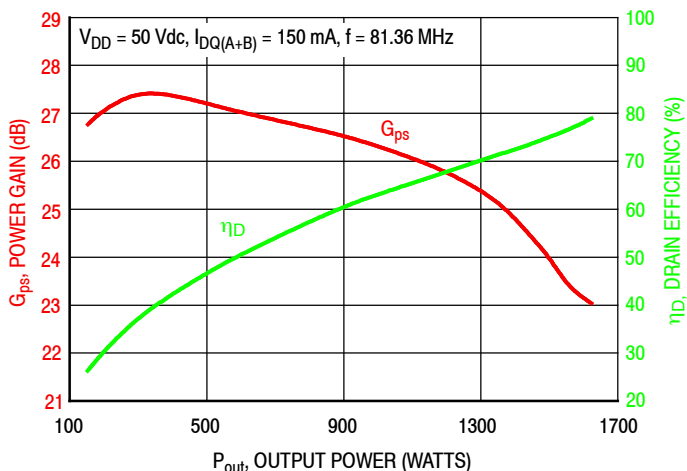

Figure 16. Power Gain and Drain Efficiency versus CW Output Power

81.36 MHz NARROWBAND REFERENCE CIRCUIT

f MHz	Z _{source} Ω	Z _{load} Ω
81.36	3.12 + j6.2	3.5 + j2.5

Z_{source} = Test circuit impedance as measured from gate to gate, balanced configuration.

Z_{load} = Test circuit impedance as measured from drain to drain, balanced configuration.

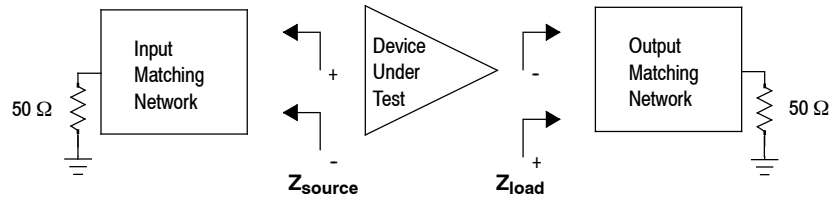
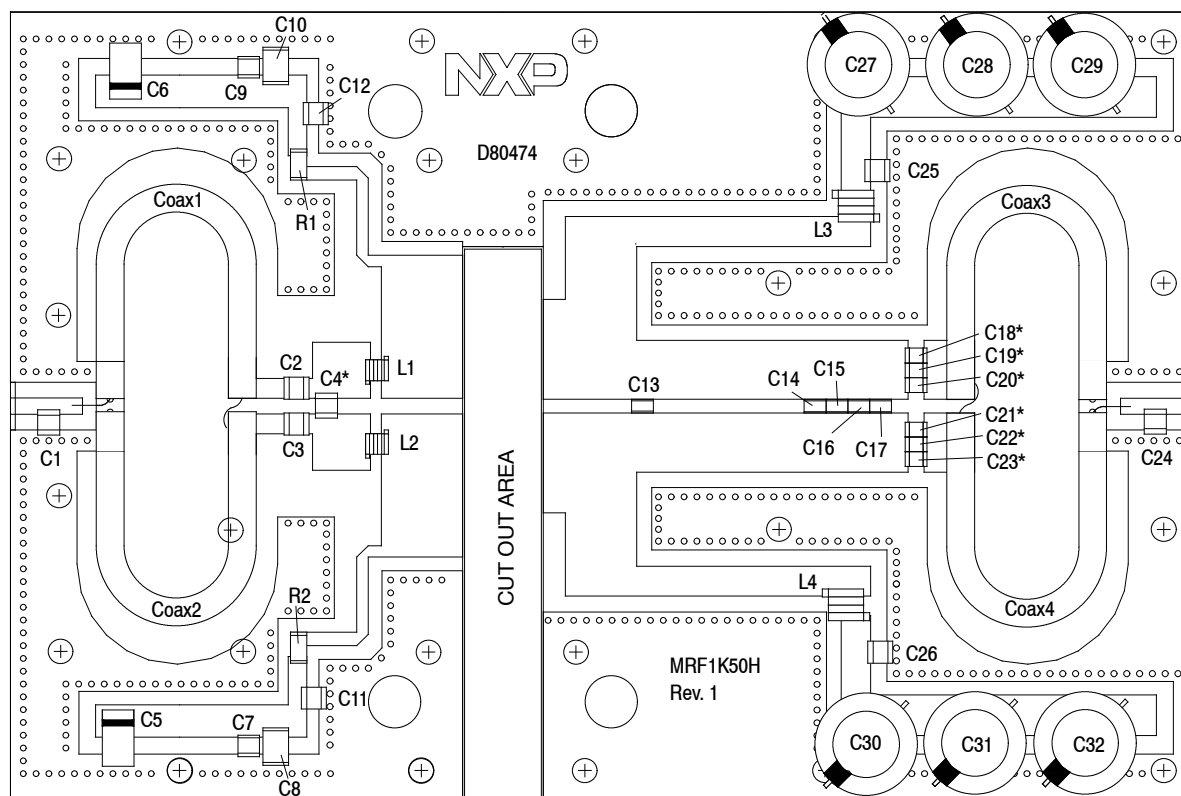

Figure 17. Narrowband Series Equivalent Source and Load Impedance — 81.36 MHz

230 MHz NARROWBAND PRODUCTION TEST FIXTURE — 6" x 4" (152 mm x 102 mm)



*C4, C18, C19, C20, C21, C22, and C23 are mounted vertically.

Figure 18. MRF1K50H Narrowband Test Circuit Component Layout — 230 MHz

Table 11. MRF1K50H Narrowband Test Circuit Component Designations and Values — 230 MHz

Part	Description	Part Number	Manufacturer
C1, C2, C3	22 pF Chip Capacitors	ATC100B220JT500XT	ATC
C4	27 pF Chip Capacitor	ATC100B270JT500XT	ATC
C5, C6	22 μ F, 35 V Tantalum Capacitors	T491X226K035AT	Kemet
C7, C9	0.1 μ F Chip Capacitors	C1210C104K5RACTU	Kemet
C8, C10	220 nF Chip Capacitors	C1812C224K5RACTU	Kemet
C11, C12, C25, C26	1000 pF Chip Capacitors	ATC100B102JT50XT	ATC
C13	51 pF Chip Capacitor	ATC800R510JT500XT	ATC
C14	24 pF Chip Capacitor	ATC800R240JT500XT	ATC
C15, C16, C17	20 pF Chip Capacitors	ATC800R200JT500XT	ATC
C18, C19, C20, C21, C22, C23	240 pF Chip Capacitors	ATC100B241JT200XT	ATC
C24	8.2 pF Chip Capacitor	ATC100B8R2CT500XT	ATC
C27, C28, C29, C30, C31, C32	470 μ F, 63 V Electrolytic Capacitors	MCGPR63V477M13X26-RH	Multicomp
Coax1, 2, 3, 4	25 Ω Semi Rigid Coax, 2.2" Shield Length	UT-141C-25	Micro-Coax
L1, L2	5 nH Inductors	A02TKLC	Coilcraft
L3, L4	6.6 nH Inductors	GA3093-ALC	Coilcraft
R1, R2	10 Ω , 1/4 W Chip Resistors	CRCW120610R0JNEA	Vishay
PCB	Arlon AD255A 0.030", $\epsilon_r = 2.55$	D80474	MTL

TYPICAL CHARACTERISTICS — 230 MHz PRODUCTION TEST FIXTURE

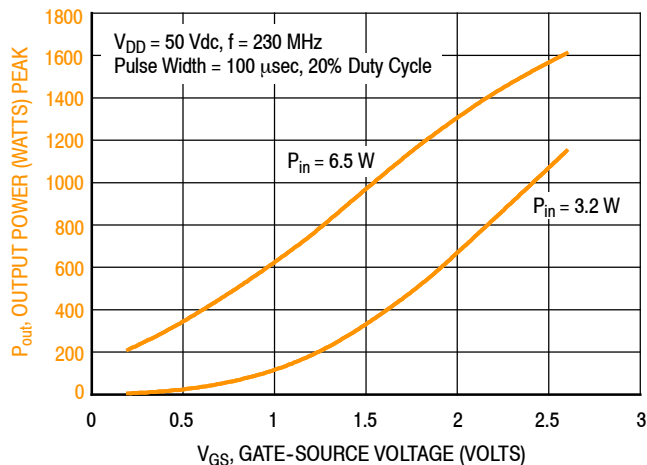
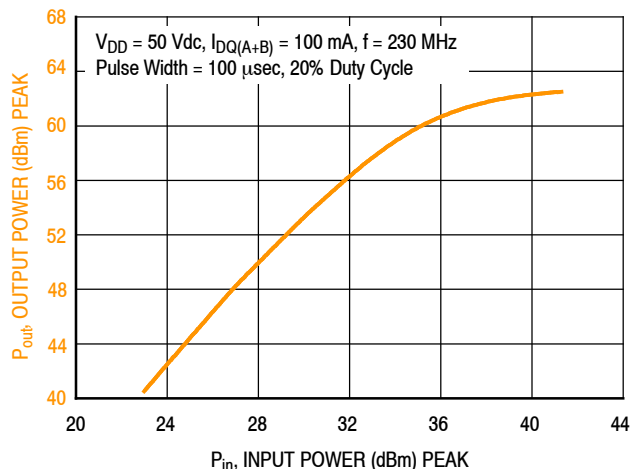

Figure 19. Output Power versus Gate-Source Voltage at a Constant Input Power



f (MHz)	P1dB (W)	P3dB (W)
230	1460	1740

Figure 20. Output Power versus Input Power

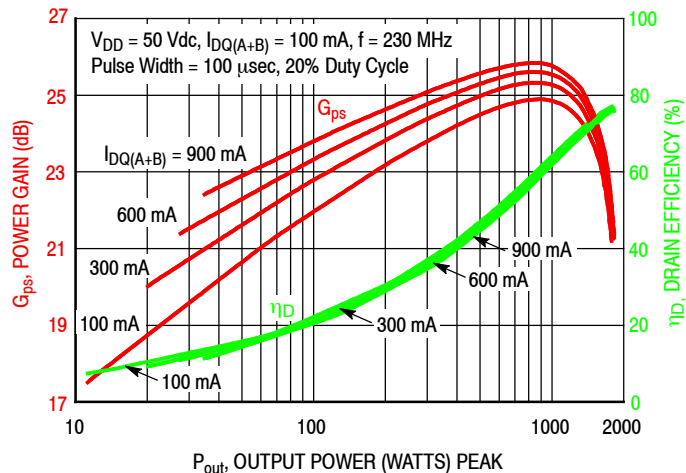

Figure 21. Power Gain and Drain Efficiency versus Output Power and Quiescent Current

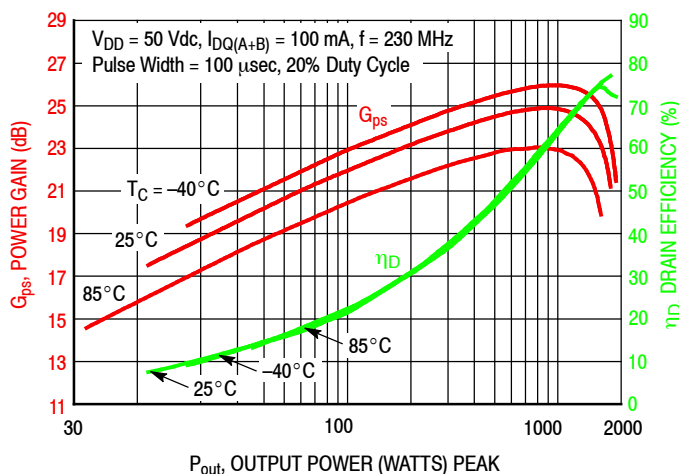

Figure 22. Power Gain and Drain Efficiency versus Output Power

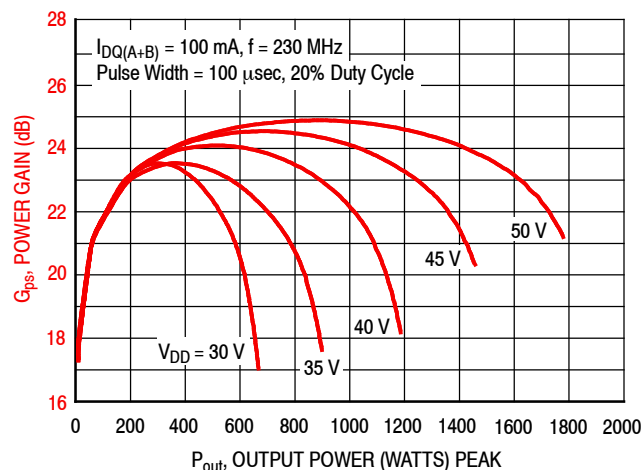

Figure 23. Power Gain versus Output Power and Drain-Source Voltage

MRF1K50H

230 MHz NARROWBAND PRODUCTION TEST FIXTURE

f MHz	Z _{source} Ω	Z _{load} Ω
230	1.4 + j2.8	2.2 + j1.7

Z_{source} = Test circuit impedance as measured from gate to gate, balanced configuration.

Z_{load} = Test circuit impedance as measured from drain to drain, balanced configuration.

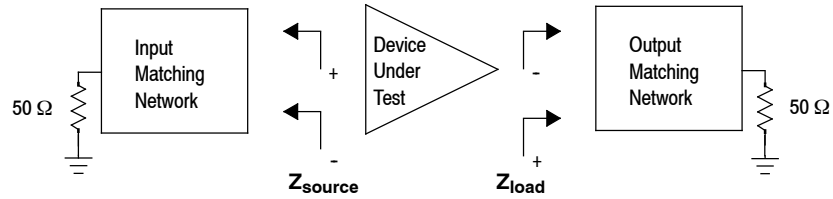
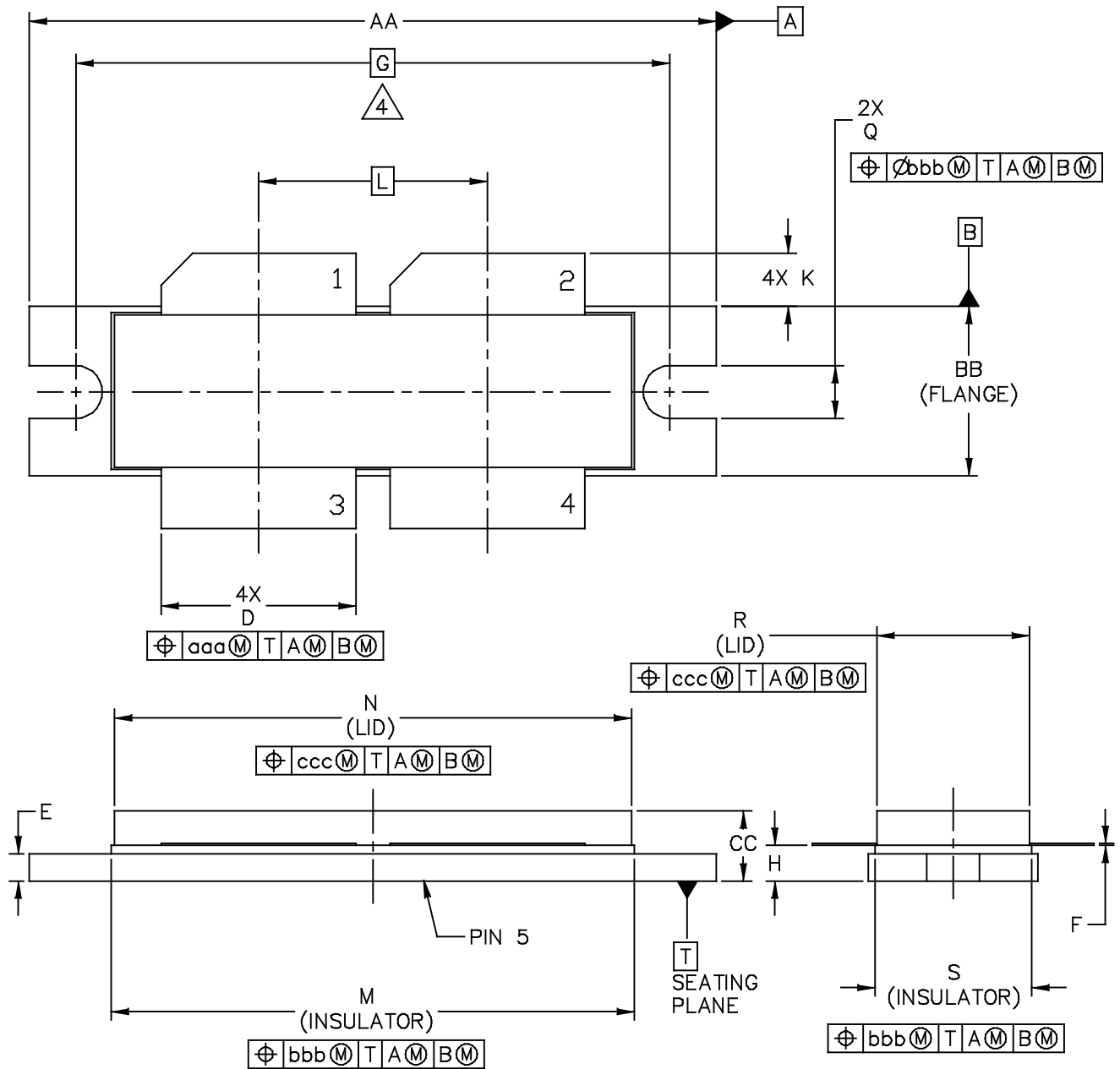

Figure 24. Narrowband Series Equivalent Source and Load Impedance — 230 MHz

PACKAGE DIMENSIONS



© NXP SEMICONDUCTORS N.V. ALL RIGHTS RESERVED	MECHANICAL OUTLINE	PRINT VERSION NOT TO SCALE
TITLE: <div style="text-align: center; font-size: 1.2em;">NI-1230-4H</div>	DOCUMENT NO: 98ASB16977C STANDARD: NON-JEDEC SOT1787-1	REV: G 03 MAR 2016

MRF1K50H

NOTES:

1. INTERPRET DIMENSIONS AND TOLERANCES PER ASME Y14.5M-1994.
2. CONTROLLING DIMENSION: INCH
3. DIMENSION H IS MEASURED .030 INCH (0.762 MM) AWAY FROM PACKAGE BODY.

4.  RECOMMENDED BOLT CENTER DIMENSION OF 1.52 INCH (38.61 MM) BASED ON M3 SCREW.

DIM	INCH		MILLIMETER		DIM	INCH		MILLIMETER	
	MIN	MAX	MIN	MAX		MIN	MAX	MIN	MAX
AA	1.615	1.625	41.02	41.28	N	1.218	1.242	30.94	31.55
BB	.395	.405	10.03	10.29	Q	.120	.130	3.05	3.30
CC	.170	.190	4.32	4.83	R	.355	.365	9.02	9.27
D	.455	.465	11.56	11.81	S	.365	.375	9.27	9.53
E	.062	.066	1.57	1.68					
F	.004	.007	0.10	0.18					
G	1.400 BSC		35.56 BSC		aaa	.013		0.33	
H	.082	.090	2.08	2.29	bbb	.010		0.25	
K	.117	.137	2.97	3.48	ccc	.020		0.51	
L	.540 BSC		13.72 BSC						
M	1.219	1.241	30.96	31.52					
© NXP SEMICONDUCTORS N.V. ALL RIGHTS RESERVED			MECHANICAL OUTLINE			PRINT VERSION NOT TO SCALE			
TITLE: NI-1230-4H					DOCUMENT NO: 98ASB16977C REV: G				
					STANDARD: NON-JEDEC				
					SOT1787-1			03 MAR 2016	

PRODUCT DOCUMENTATION, SOFTWARE AND TOOLS

Refer to the following resources to aid your design process.

Application Notes

- AN1908: Solder Reflow Attach Method for High Power RF Devices in Air Cavity Packages
- AN1955: Thermal Measurement Methodology of RF Power Amplifiers

Engineering Bulletins

- EB212: Using Data Sheet Impedances for RF LDMOS Devices

Software

- Electromigration MTTF Calculator
- RF High Power Model
- .s2p File

Development Tools

- Printed Circuit Boards

To Download Resources Specific to a Given Part Number:

1. Go to <http://www.nxp.com/RF>
2. Search by part number
3. Click part number link
4. Choose the desired resource from the drop down menu

REVISION HISTORY

The following table summarizes revisions to this document.

Revision	Date	Description
0	June 2016	<ul style="list-style-type: none">• Initial Release of Data Sheet
1	Jan. 2017	<ul style="list-style-type: none">• Table 2, Thermal Characteristics: updated thermal resistance to show data at 88 MHz, p. 2• Table 6, Ordering Information: corrected number of units in reel to 50, p. 3• Figure 4, Maximum Transient Thermal Impedance: added performance graph to data sheet, p. 4
1.1	Mar. 2017	<ul style="list-style-type: none">• Feature bullets: added product longevity program bullet, p. 1• Figure 12, 87.5 MHz Harmonics @ 1200 W CW: corrected H2, H3 and H4 frequency values, p. 10

How to Reach Us:

Home Page:
nxp.com

Web Support:
nxp.com/support

Information in this document is provided solely to enable system and software implementers to use NXP products. There are no express or implied copyright licenses granted hereunder to design or fabricate any integrated circuits based on the information in this document. NXP reserves the right to make changes without further notice to any products herein.

NXP makes no warranty, representation, or guarantee regarding the suitability of its products for any particular purpose, nor does NXP assume any liability arising out of the application or use of any product or circuit, and specifically disclaims any and all liability, including without limitation consequential or incidental damages. "Typical" parameters that may be provided in NXP data sheets and/or specifications can and do vary in different applications, and actual performance may vary over time. All operating parameters, including "typicals," must be validated for each customer application by customer's technical experts. NXP does not convey any license under its patent rights nor the rights of others. NXP sells products pursuant to standard terms and conditions of sale, which can be found at the following address: nxp.com/SalesTermsandConditions.

NXP, the NXP logo, Freescale, and the Freescale logo are trademarks of NXP B.V. All other product or service names are the property of their respective owners.
© 2016–2017 NXP B.V.



Mouser Electronics

Authorized Distributor

Click to View Pricing, Inventory, Delivery & Lifecycle Information:

[NXP:](#)

[MRF1K50HR5](#) [MRF1K50H-TF3](#) [MRF1K50H-TF4](#) [MRF1K50H-TF2](#) [MRF1K50H-TF1](#) [MRF1K50H-TF5](#)