

IMPORTANT NOTICE

Dear customer,

As of December 7th, 2015 BL RF Power of NXP Semiconductors will operate as an independent company under the new trade name Ampleon, which will be used in future data sheets together with new contact details.

In data sheets, where the previous Philips references is mentioned, please use the new links as shown below.

<http://www.philips.semiconductors.com> use <http://www.ampleon.com>

<http://www.semiconductors.philips.com> use <http://www.ampleon.com> (Internet)

sales.addresses@www.semiconductors.philips.com use
<http://www.ampleon.com/sales>

The copyright notice at the bottom of each page (or elsewhere in the document, depending on the version)

- © Koninklijke Philips Electronics N.V. (year). All rights reserved -
is replaced with:

- © Ampleon B.V. (year). All rights reserved. -

If you have any questions related to the data sheet, please contact our nearest sales office (details via <http://www.ampleon.com/sales>).

Thank you for your cooperation and understanding,

Ampleon

UHF power MOS transistor

BLF542

FEATURES

- High power gain
- Easy power control
- Good thermal stability
- Gold metallization ensures excellent reliability
- Withstands full load mismatch
- Designed for broadband operation.

APPLICATIONS

- Large signal amplifier applications in the UHF frequency range.

DESCRIPTION

N-channel enhancement mode vertical D-MOS power transistor encapsulated in a 6-lead, SOT171A flange package with a ceramic cap. All leads are isolated from the flange.

PINNING - SOT171A

PIN	DESCRIPTION
1	source
2	source
3	gate
4	drain
5	source
6	source

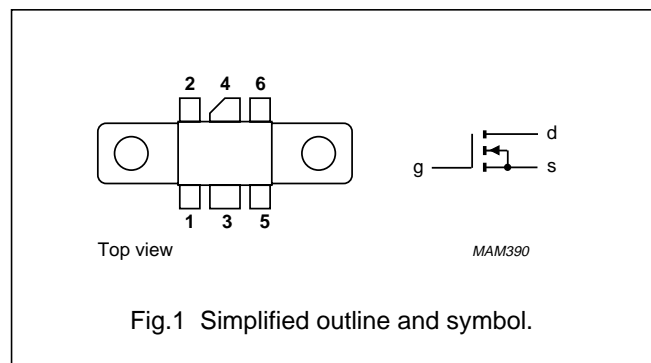

QUICK REFERENCE DATA

RF performance at $T_h = 25\text{ }^\circ\text{C}$ in a common source class-B circuit.

MODE OF OPERATION	f (MHz)	V_{DS} (V)	P_L (W)	G_p (dB)	η_D (%)
CW, class-B	500	28	5	>13	>50

CAUTION

This product is supplied in anti-static packing to prevent damage caused by electrostatic discharge during transport and handling. For further information, refer to Philips specs.: SNW-EQ-608, SNW-FQ-302A and SNW-FQ-302B.

WARNING

Product and environmental safety - toxic materials

This product contains beryllium oxide. The product is entirely safe provided that the BeO disc is not damaged. All persons who handle, use or dispose of this product should be aware of its nature and of the necessary safety precautions. After use, dispose of as chemical or special waste according to the regulations applying at the location of the user. It must never be thrown out with the general or domestic waste.

UHF power MOS transistor

BLF542

LIMITING VALUES

In accordance with the Absolute Maximum Rating System (IEC 60134).

SYMBOL	PARAMETER	CONDITIONS	MIN.	MAX.	UNIT
V_{DS}	drain-source voltage		–	65	V
V_{GS}	gate-source voltage		–	± 20	V
I_D	drain current (DC)		–	1.5	A
P_{tot}	total power dissipation	$T_{mb} = 25\text{ }^\circ\text{C}$	–	20	W
T_{stg}	storage temperature		–65	+150	$^\circ\text{C}$
T_j	junction temperature		–	200	$^\circ\text{C}$

THERMAL CHARACTERISTICS

SYMBOL	PARAMETER	VALUE	UNIT
$R_{th\ j-mb}$	thermal resistance from junction to mounting base	8.8	K/W
$R_{th\ mb-h}$	thermal resistance from mounting base to heatsink	0.4	K/W

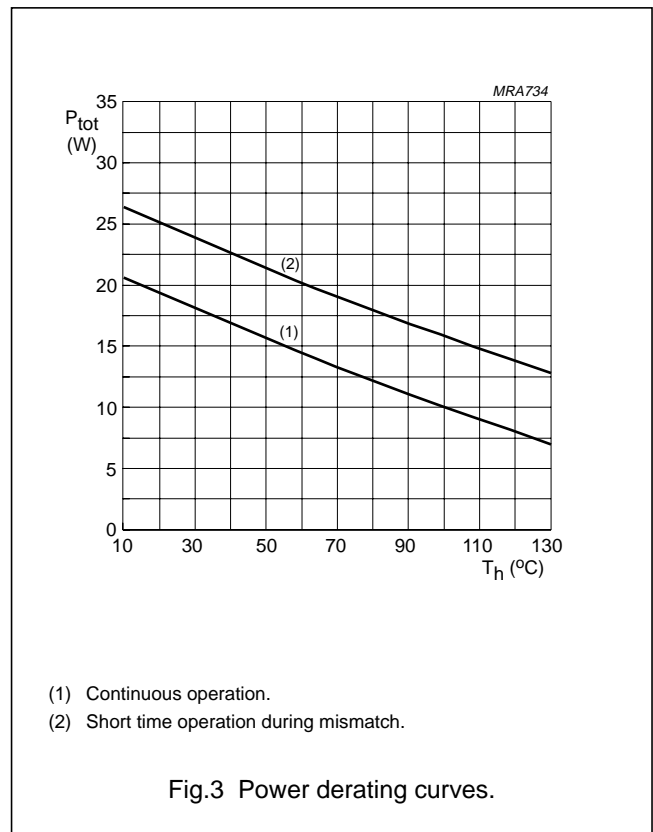
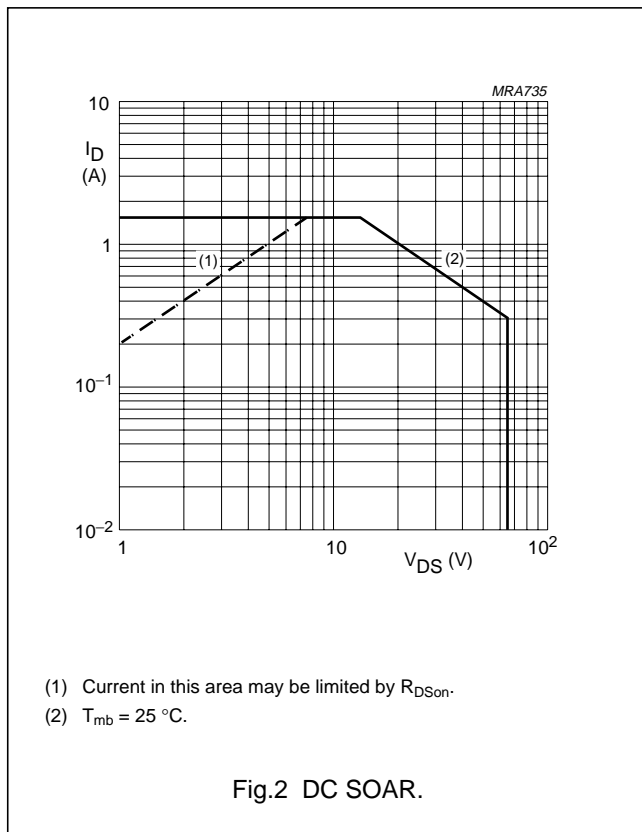

UHF power MOS transistor

BLF542

CHARACTERISTICS $T_j = 25\text{ °C}$ unless otherwise specified.

SYMBOL	PARAMETER	CONDITIONS	MIN.	TYP.	MAX.	UNIT
$V_{(BR)DSS}$	drain-source breakdown voltage	$I_D = 0.1\text{ mA}; V_{GS} = 0$	65	–	–	V
I_{DSS}	drain-source leakage current	$V_{GS} = 0; V_{DS} = 28\text{ V}$	–	–	10	μA
I_{GSS}	gate-source leakage current	$V_{GS} = \pm 20\text{ V}; V_{DS} = 0$	–	–	1	μA
V_{GSth}	gate-source threshold voltage	$I_D = 10\text{ mA}; V_{DS} = 10\text{ V}$	2	–	4.5	V
g_{fs}	forward transconductance	$I_D = 0.3\text{ A}; V_{DS} = 10\text{ V}$	160	240	–	mS
R_{DSon}	drain-source on-resistance	$I_D = 0.3\text{ A}; V_{GS} = 15\text{ V}$	–	3.3	5	Ω
I_{DSX}	on-state drain current	$V_{GS} = 15\text{ V}; V_{DS} = 10\text{ V}$	–	1.4	–	A
C_{is}	input capacitance	$V_{GS} = 0; V_{DS} = 28\text{ V}; f = 1\text{ MHz}$	–	14	–	pF
C_{os}	output capacitance	$V_{GS} = 0; V_{DS} = 28\text{ V}; f = 1\text{ MHz}$	–	9.4	–	pF
C_{rs}	feedback capacitance	$V_{GS} = 0; V_{DS} = 28\text{ V}; f = 1\text{ MHz}$	–	1.7	–	pF

 V_{GS} group indicator

GROUP	LIMITS (V)		GROUP	LIMITS (V)	
	MIN.	MAX.		MIN.	MAX.
A	2.0	2.1	O	3.3	3.4
B	2.1	2.2	P	3.4	3.5
C	2.2	2.3	Q	3.5	3.6
D	2.3	2.4	R	3.6	3.7
E	2.4	2.5	S	3.7	3.8
F	2.5	2.6	T	3.8	3.9
G	2.6	2.7	U	3.9	4.0
H	2.7	2.8	V	4.0	4.1
J	2.8	2.9	W	4.1	4.2
K	2.9	3.0	X	4.2	4.3
L	3.0	3.1	Y	4.3	4.4
M	3.1	3.2	Z	4.4	4.5
N	3.2	3.3			

UHF power MOS transistor

BLF542

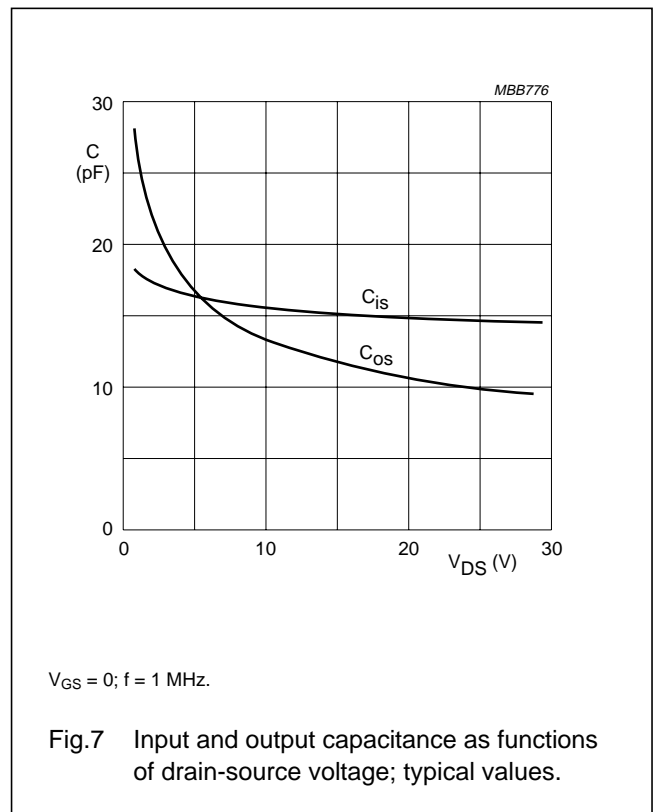
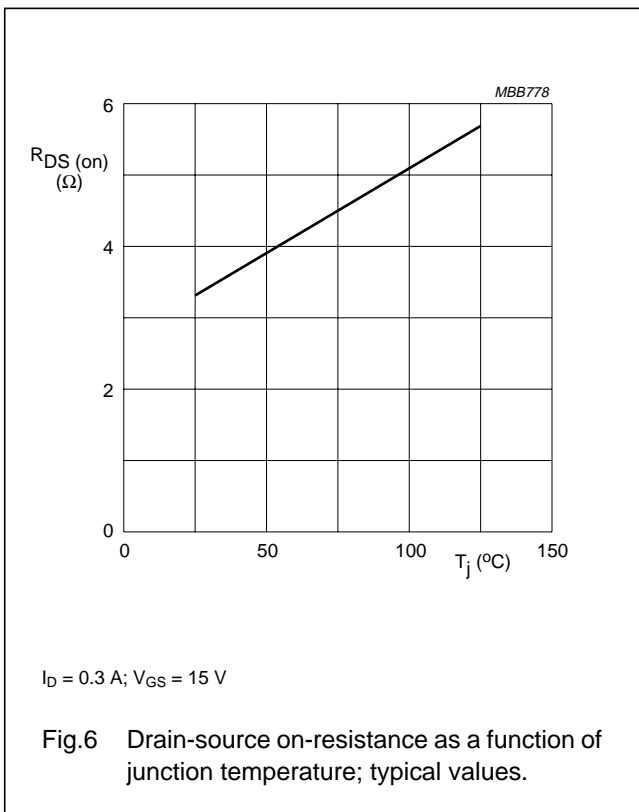
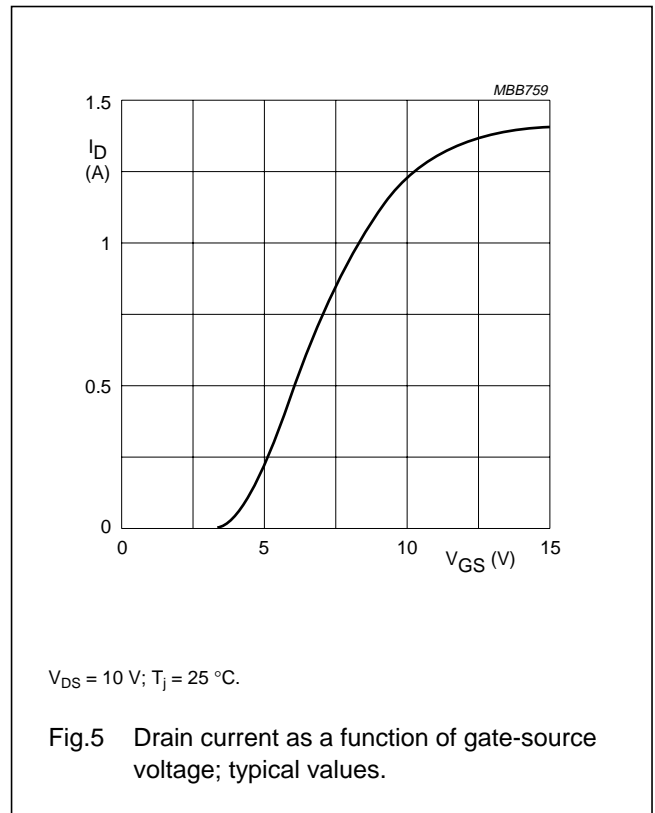
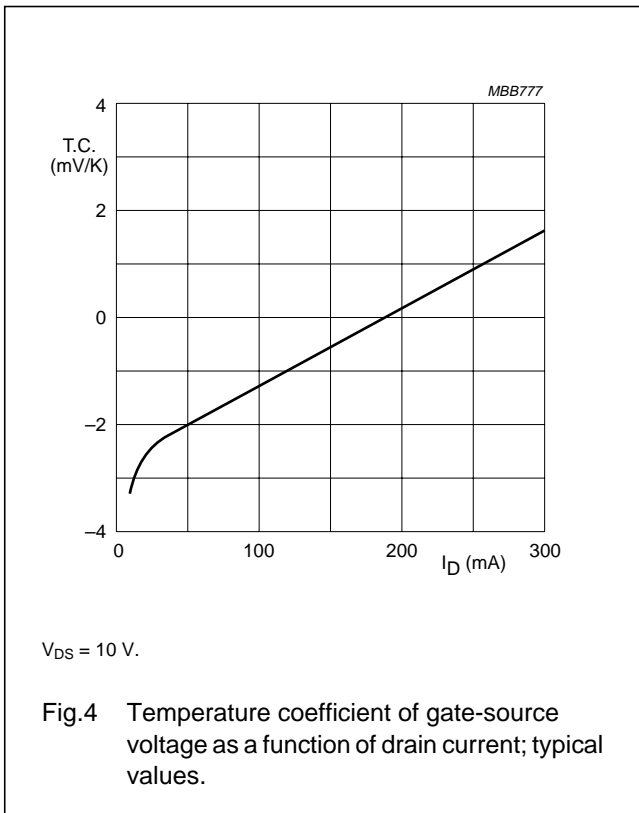

UHF power MOS transistor

BLF542

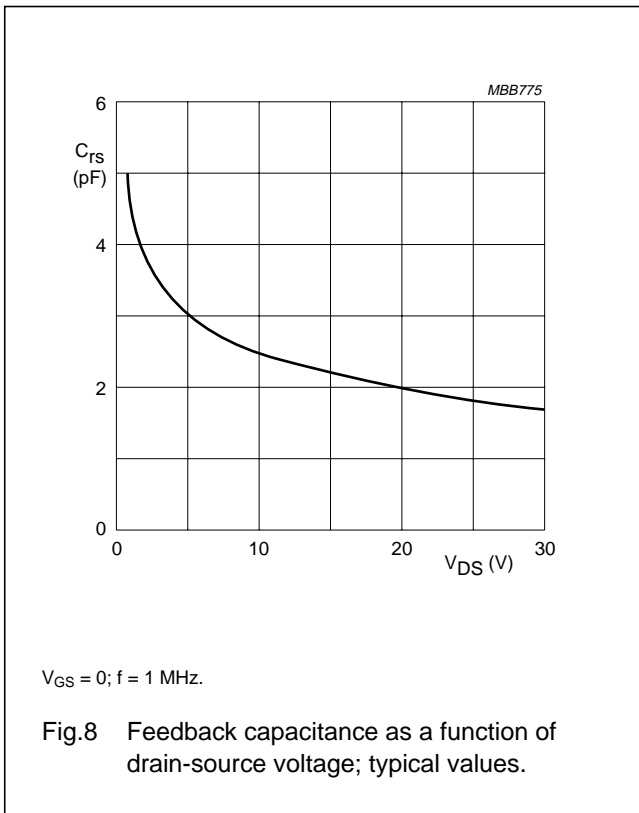

APPLICATION INFORMATION FOR CLASS-B OPERATION

$T_{mb} = 25 \text{ }^\circ\text{C}$ unless otherwise specified.

RF performance in CW operation in a common source class-B test circuit.

MODE OF OPERATION	f (MHz)	V_{DS} (V)	I_{DQ} (mA)	P_L (W)	G_p (dB)	η_D (%)
CW, class-B	500	28	50	5	>13 typ. 16.5	>50 typ. 59

Ruggedness in class-B operation

The BLF542 is capable of withstanding a full load mismatch corresponding to $V_{SWR} = 50:1$ through all phases under the following conditions: $V_{DS} = 28 \text{ V}$; $f = 500 \text{ MHz}$ at rated output power.

UHF power MOS transistor

BLF542

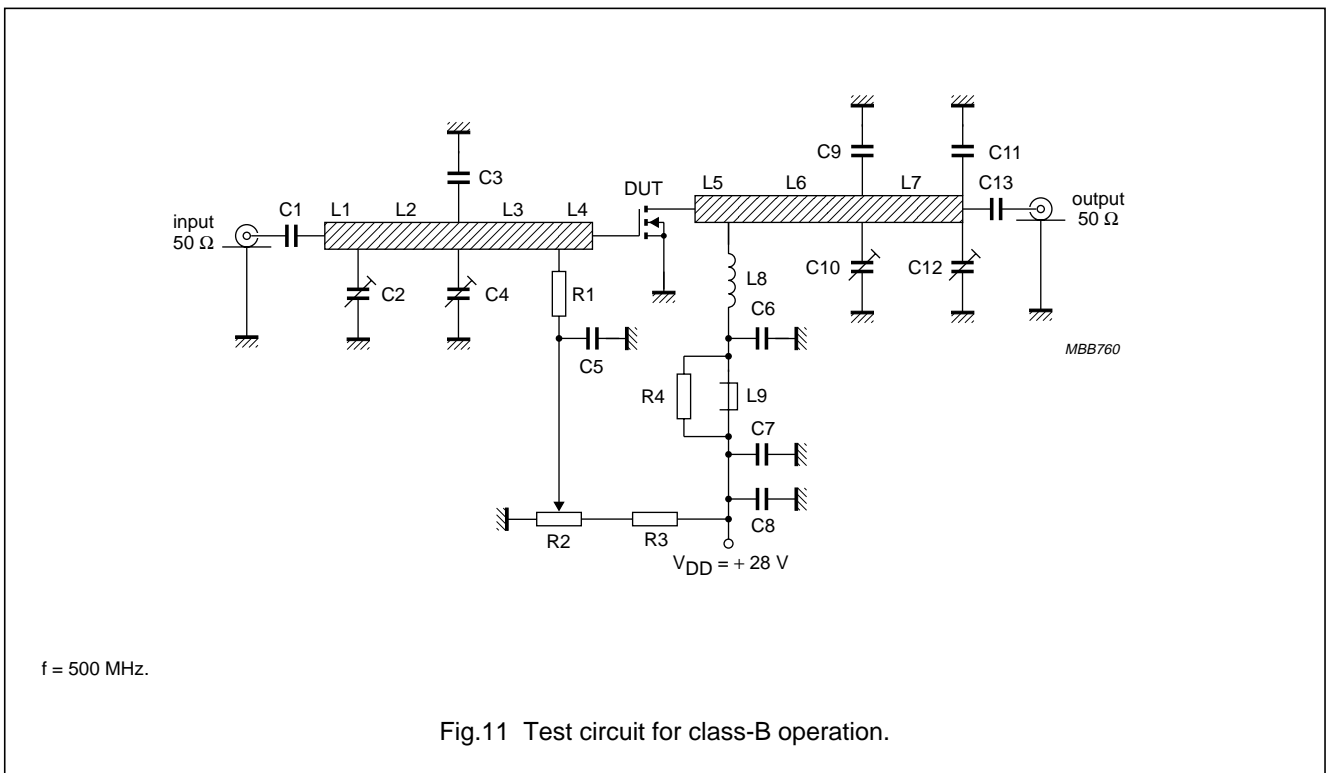
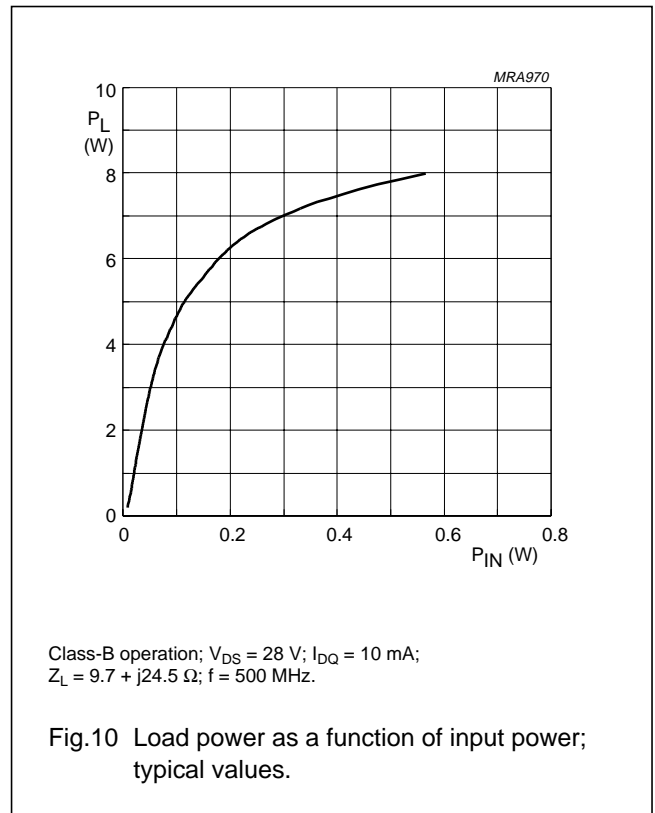
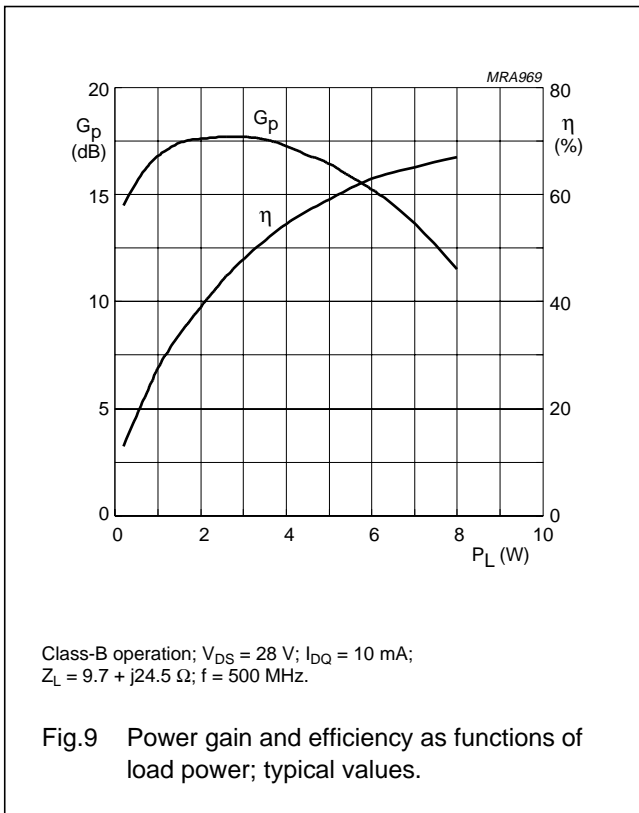

UHF power MOS transistor

BLF542

List of components (see Fig.11)

COMPONENT	DESCRIPTION	VALUE	DIMENSIONS	CATALOGUE NO.
C1, C5, C13	multilayer ceramic chip capacitor; note 1	390 pF		
C2, C4, C10, C12	film dielectric trimmer	2 to 18 pF		222 809 05217
C3, C9	multilayer ceramic chip capacitor; note 1	39 pF		
C6	multilayer ceramic chip capacitor; note 2	220 pF		
C7	multilayer ceramic chip capacitor	100 nF		2222 852 47104
C8	electrolytic capacitor	63 V, 10 μ F		2222 030 28109
C11	multilayer ceramic chip capacitor; note 1	10 pF		
L1	stripline; note 3	50 Ω	11 mm \times 2.5 mm	
L2	stripline; note 3	50 Ω	37 mm \times 2.5 mm	
L3	stripline; note 3	50 Ω	13 mm \times 2.5 mm	
L4, L5	stripline; note 3	42 Ω	3 mm \times 3 mm	
L6	stripline; note 3	50 Ω	39 mm \times 2.5 mm	
L7	stripline; note 3	50 Ω	22 mm \times 2.5 mm	
L8	8 turns 0.8 mm enamelled copper wire	250 nH	length 9 mm int. dia. 6 mm leads 2 \times 5 mm	
L9	grade 3B Ferroxcube wideband RF choke			4312 020 36640
R1	metal film resistor	10 k Ω , 0.4 W		2322 151 71003
R2	10 turn potentiometer	50 k Ω		
R3	metal film resistor	205 k Ω , 0.4 W		2322 151 72054
R4	metal film resistor	10 Ω , 0.4 W		2322 151 71009

Notes

1. American Technical Ceramics (ATC) capacitor, type 100A or other capacitor of the same quality.
2. American Technical Ceramics (ATC) capacitor, type 100B or other capacitor of the same quality.
3. The striplines are on a double copper-clad printed circuit board with PTFE fibre-glass dielectric ($\epsilon_r = 2.2$); thickness $\frac{1}{32}$ inch.

UHF power MOS transistor

BLF542

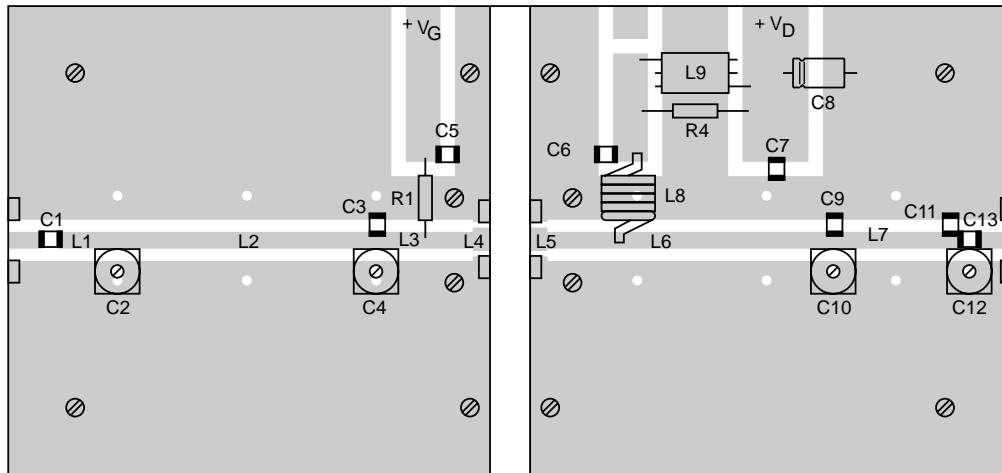

MBB762

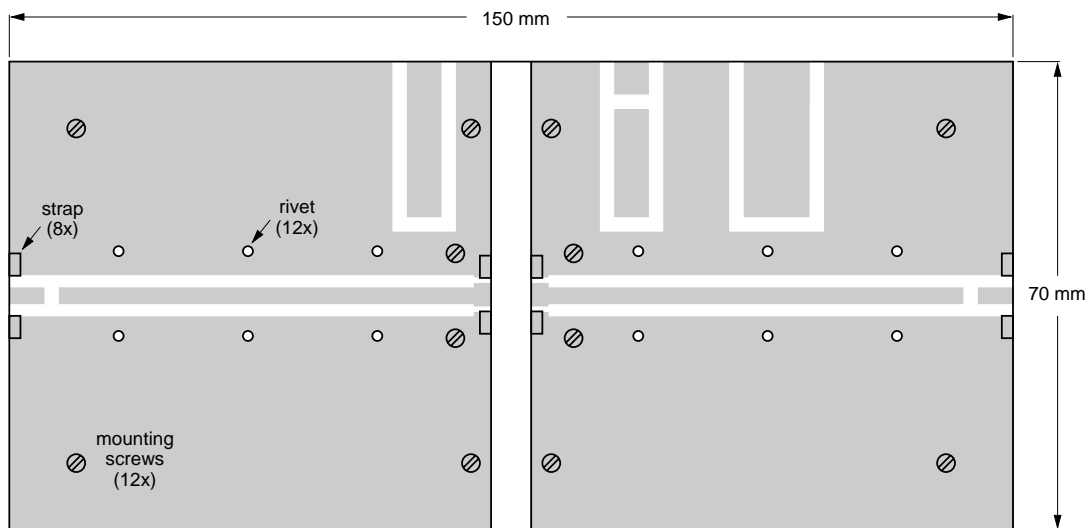

MBB761

The components are mounted on one side of a copper-clad printed circuit board; the other side is unetched and serves as a ground plane. Earth connections from the component side to the ground plane are made by means of fixing screws, hollow rivets and copper foil straps, as shown.

Fig.12 Component layout for 500 MHz test circuit.

UHF power MOS transistor

BLF542

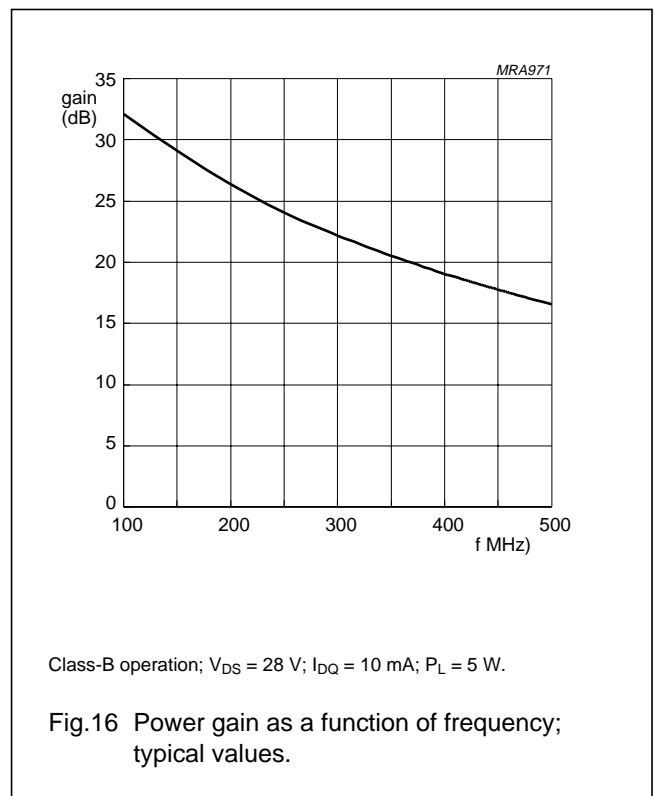
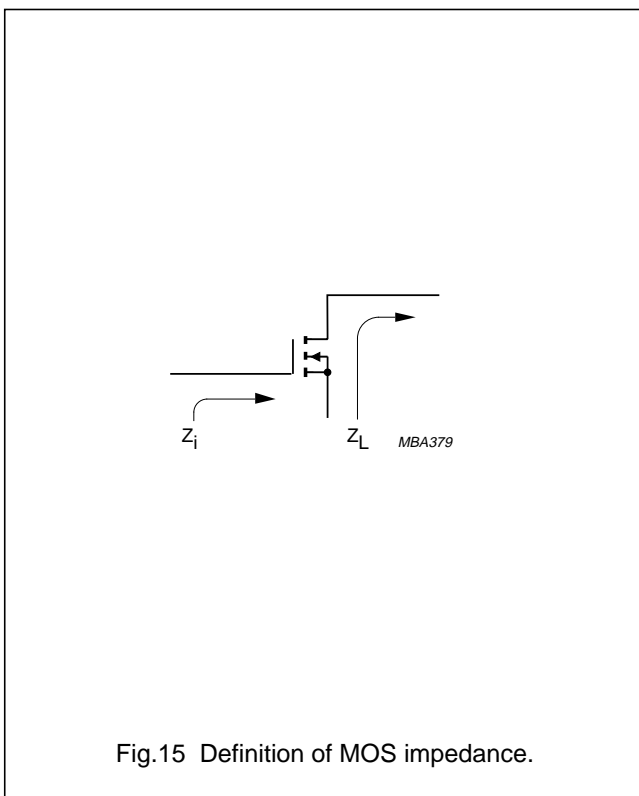
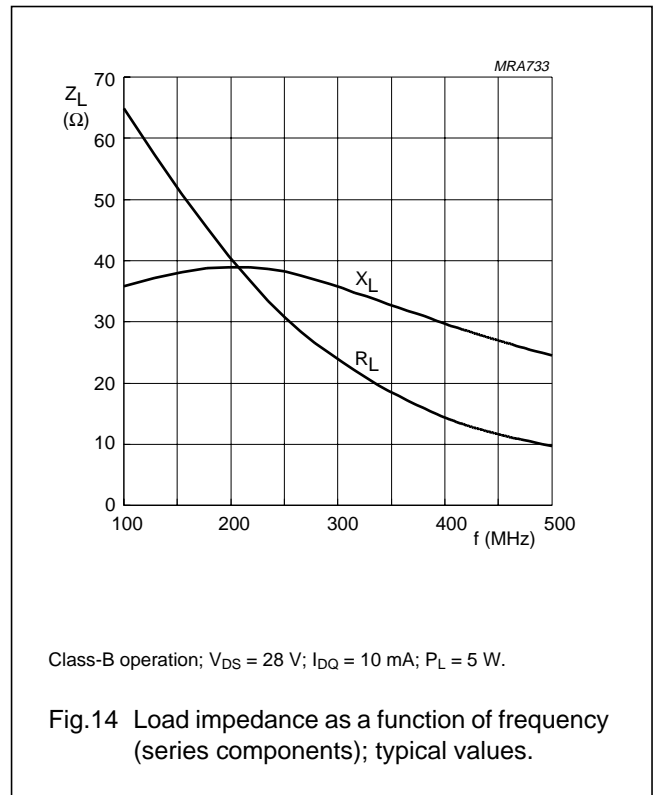
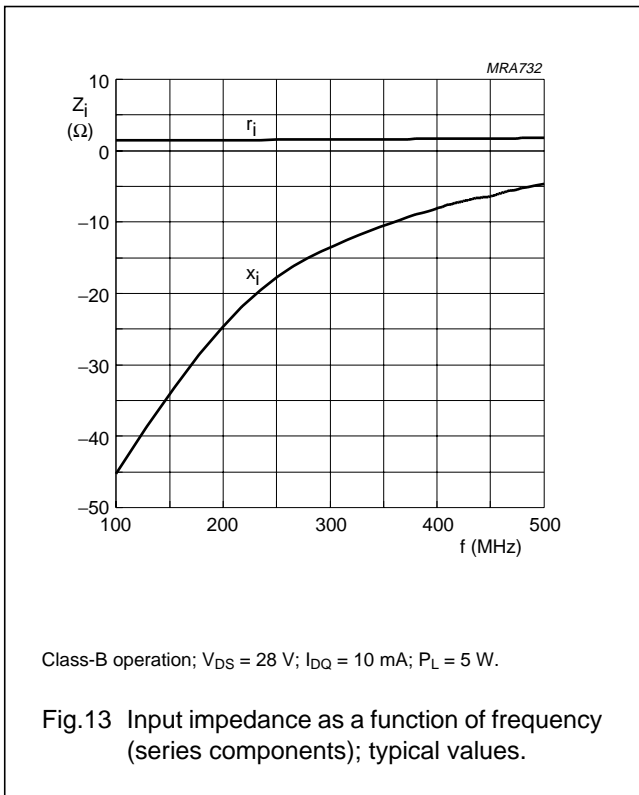

UHF power MOS transistor

BLF542

BLF542 scattering parameters $V_{DS} = 28\text{ V}$; $I_D = 10\text{ mA}$; note 1

f (MHz)	S ₁₁		S ₂₁		S ₁₂		S ₂₂	
	S ₁₁	∠ Φ	S ₂₁	∠ Φ	S ₁₂	∠ Φ	S ₂₂	∠ Φ
5	1.00	-3.0	5.88	178.0	0.00	0.0	1.00	-2.3
10	1.00	-6.0	5.88	175.0	0.01	84.7	1.01	-6.0
20	1.00	-12.0	5.86	169.0	0.02	80.4	1.00	-11.0
30	0.99	-17.9	5.74	164.0	0.03	74.8	1.00	-17.2
40	0.98	-23.6	5.65	159.0	0.04	70.2	0.99	-22.4
50	0.98	-29.3	5.55	154.0	0.04	65.6	0.98	-27.3
60	0.97	-34.8	5.43	150.0	0.05	61.2	0.97	-32.1
70	0.96	-40.1	5.31	145.0	0.06	56.9	0.96	-36.8
80	0.94	-45.3	5.19	140.0	0.07	52.4	0.96	-41.8
90	0.93	-50.3	5.03	135.0	0.07	47.9	0.94	-46.9
100	0.92	-54.9	4.86	131.0	0.08	43.6	0.93	-51.6
125	0.89	-65.5	4.42	122.0	0.09	34.7	0.89	-61.6
150	0.87	-75.5	4.06	113.0	0.10	26.8	0.88	-70.0
175	0.85	-84.2	3.71	105.0	0.10	19.0	0.86	-78.2
200	0.83	-91.7	3.35	97.3	0.10	12.4	0.83	-85.3
250	0.82	-105.0	2.81	84.6	0.11	1.2	0.82	-96.8
300	0.81	-116.0	2.34	73.6	0.11	-8.6	0.81	-107.0
350	0.81	-125.0	2.00	64.0	0.10	-16.7	0.82	-115.0
400	0.81	-133.0	1.70	55.5	0.10	-23.8	0.82	-121.0
450	0.82	-140.0	1.48	47.7	0.09	-30.2	0.83	-128.0
500	0.83	-146.0	1.28	40.9	0.09	-35.6	0.84	-133.0
600	0.86	-157.0	1.00	29.0	0.08	-44.9	0.87	-142.0
700	0.87	-166.0	0.79	18.6	0.07	-52.3	0.89	-149.0
800	0.89	-175.0	0.64	9.8	0.06	-58.1	0.90	-155.0
900	0.90	178.0	0.53	2.0	0.05	-62.4	0.92	-160.0
1000	0.91	171.0	0.45	-4.8	0.04	-64.9	0.93	-165.0

Note

- For more extensive s-parameters see internet:
<http://www.semiconductors.philips.com/markets/communications/wirelesscommunication/broadcast>.

UHF power MOS transistor

BLF542

BLF542 scattering parameters $V_{DS} = 28\text{ V}$; $I_D = 50\text{ mA}$.; note 1

f (MHz)	S ₁₁		S ₂₁		S ₁₂		S ₂₂	
	S ₁₁	∠ Φ	S ₂₁	∠ Φ	S ₁₂	∠ Φ	S ₂₂	∠ Φ
5	1.00	-4.1	12.20	177.0	0.00	0.0	0.99	-3.2
10	1.00	-8.2	12.20	173.0	0.01	83.5	1.00	-7.8
20	0.99	-16.3	12.10	167.0	0.02	78.1	0.99	-14.5
30	0.98	-24.1	11.70	161.0	0.03	71.7	0.98	-22.3
40	0.97	-31.7	11.40	155.0	0.03	66.2	0.96	-28.8
50	0.95	-39.1	11.10	150.0	0.04	60.9	0.94	-35.1
60	0.93	-46.1	10.70	144.0	0.05	55.8	0.93	-41.1
70	0.92	-52.7	10.30	139.0	0.06	51.1	0.91	-46.8
80	0.90	-59.1	9.92	134.0	0.06	46.2	0.89	-52.7
90	0.88	-65.1	9.47	129.0	0.07	41.6	0.87	-58.4
100	0.86	-70.3	9.00	125.0	0.07	37.3	0.85	-63.6
125	0.82	-81.9	7.95	116.0	0.08	28.7	0.80	-74.1
150	0.80	-92.5	7.12	107.0	0.08	21.2	0.78	-82.8
175	0.77	-101.0	6.37	99.9	0.08	14.2	0.75	-90.7
200	0.75	-109.0	5.68	93.5	0.08	8.5	0.73	-97.4
250	0.74	-121.0	4.67	82.4	0.09	-1.3	0.72	-108.0
300	0.73	-130.0	3.87	72.9	0.08	-9.4	0.71	-116.0
350	0.74	-138.0	3.29	64.5	0.08	-16.3	0.72	-123.0
400	0.75	-145.0	2.81	57.2	0.08	-22.2	0.73	-129.0
450	0.76	-151.0	2.44	50.3	0.07	-27.7	0.74	-134.0
500	0.77	-156.0	2.13	44.2	0.07	-32.2	0.75	-138.0
600	0.79	-165.0	1.67	33.3	0.06	-40.0	0.79	-145.0
700	0.82	-173.0	1.34	23.6	0.05	-46.1	0.82	-152.0
800	0.84	180.0	1.10	15.2	0.04	-50.4	0.85	-157.0
900	0.86	173.0	0.92	7.5	0.04	-52.9	0.87	-162.0
1000	0.87	167.0	0.78	0.7	0.03	-52.8	0.88	-166.0

Note

- For more extensive s-parameters see internet:
<http://www.semiconductors.philips.com/markets/communications/wirelesscommunication/broadcast>.

UHF power MOS transistor

BLF542

PACKAGE OUTLINE

Flanged ceramic package; 2 mounting holes; 6 leads

SOT171A

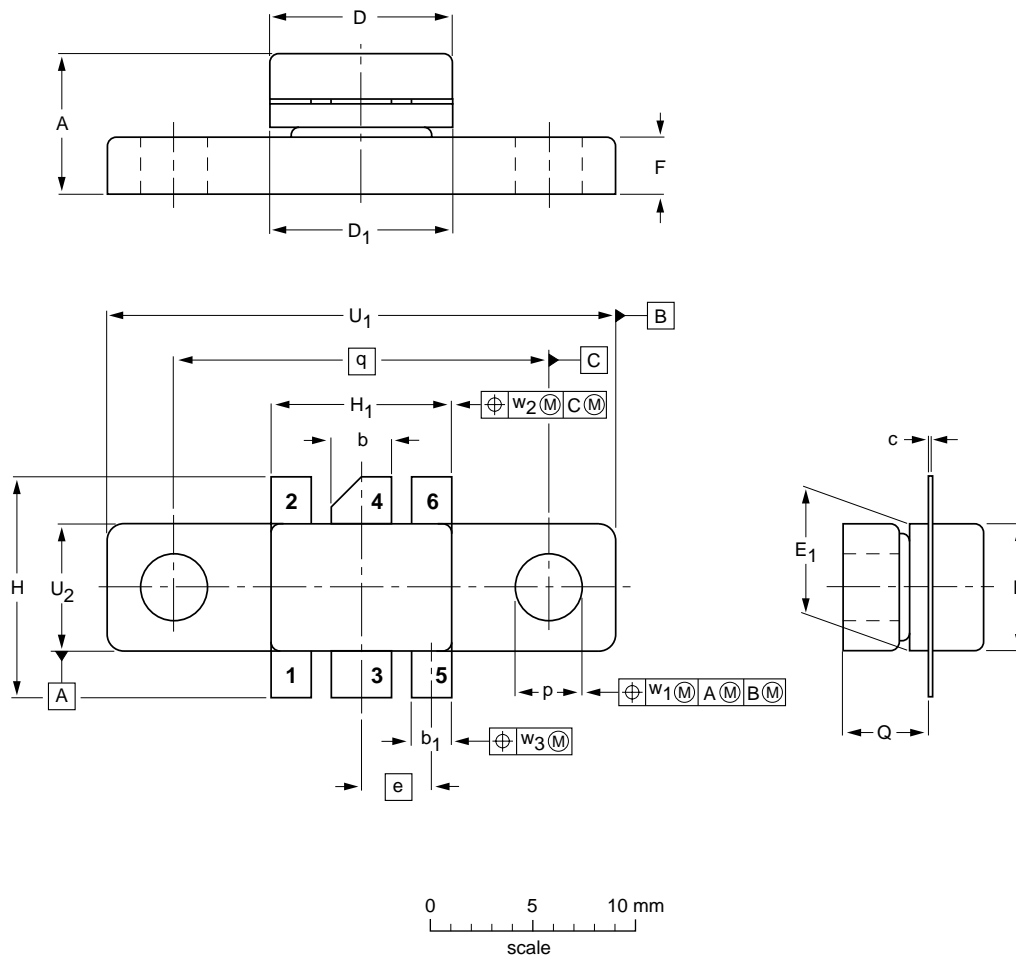

DIMENSIONS (millimetre dimensions are derived from the original inch dimensions)

UNIT	A	b	b ₁	c	D	D ₁	E	E ₁	e	F	H	H ₁	p	Q	q	U ₁	U ₂	w ₁	w ₂	w ₃
mm	6.81 6.07	3.18 2.92	2.13 1.88	0.16 0.07	9.25 9.04	9.27 9.02	5.95 5.74	5.97 5.72	3.58	3.05 2.54	11.31 10.54	9.27 9.01	3.43 3.17	4.32 4.11	18.42	24.90 24.63	5.97 5.72	0.25	0.51	0.25
inches	0.268 0.239	0.125 0.115	0.084 0.074	0.006 0.003	0.364 0.356	0.365 0.355	0.234 0.226	0.235 0.225	0.140	0.120 0.100	0.445 0.415	0.365 0.355	0.135 0.125	0.170 0.162	0.725	0.980 0.970	0.235 0.225	0.010	0.020	0.010

OUTLINE VERSION	REFERENCES				EUROPEAN PROJECTION	ISSUE DATE
	IEC	JEDEC	EIAJ			
SOT171A						99-03-29

UHF power MOS transistor

BLF542

DATA SHEET STATUS

LEVEL	DATA SHEET STATUS ⁽¹⁾	PRODUCT STATUS ⁽²⁾⁽³⁾	DEFINITION
I	Objective data	Development	This data sheet contains data from the objective specification for product development. Philips Semiconductors reserves the right to change the specification in any manner without notice.
II	Preliminary data	Qualification	This data sheet contains data from the preliminary specification. Supplementary data will be published at a later date. Philips Semiconductors reserves the right to change the specification without notice, in order to improve the design and supply the best possible product.
III	Product data	Production	This data sheet contains data from the product specification. Philips Semiconductors reserves the right to make changes at any time in order to improve the design, manufacturing and supply. Relevant changes will be communicated via a Customer Product/Process Change Notification (CPCN).

Notes

1. Please consult the most recently issued data sheet before initiating or completing a design.
2. The product status of the device(s) described in this data sheet may have changed since this data sheet was published. The latest information is available on the Internet at URL <http://www.semiconductors.philips.com>.
3. For data sheets describing multiple type numbers, the highest-level product status determines the data sheet status.

DEFINITIONS

Short-form specification — The data in a short-form specification is extracted from a full data sheet with the same type number and title. For detailed information see the relevant data sheet or data handbook.

Limiting values definition — Limiting values given are in accordance with the Absolute Maximum Rating System (IEC 60134). Stress above one or more of the limiting values may cause permanent damage to the device. These are stress ratings only and operation of the device at these or at any other conditions above those given in the Characteristics sections of the specification is not implied. Exposure to limiting values for extended periods may affect device reliability.

Application information — Applications that are described herein for any of these products are for illustrative purposes only. Philips Semiconductors make no representation or warranty that such applications will be suitable for the specified use without further testing or modification.

DISCLAIMERS

Life support applications — These products are not designed for use in life support appliances, devices, or systems where malfunction of these products can reasonably be expected to result in personal injury. Philips Semiconductors customers using or selling these products for use in such applications do so at their own risk and agree to fully indemnify Philips Semiconductors for any damages resulting from such application.

Right to make changes — Philips Semiconductors reserves the right to make changes in the products - including circuits, standard cells, and/or software - described or contained herein in order to improve design and/or performance. When the product is in full production (status 'Production'), relevant changes will be communicated via a Customer Product/Process Change Notification (CPCN). Philips Semiconductors assumes no responsibility or liability for the use of any of these products, conveys no licence or title under any patent, copyright, or mask work right to these products, and makes no representations or warranties that these products are free from patent, copyright, or mask work right infringement, unless otherwise specified.

Philips Semiconductors – a worldwide company

Contact information

For additional information please visit <http://www.semiconductors.philips.com>. Fax: +31 40 27 24825

For sales offices addresses send e-mail to: sales.addresses@www.semiconductors.philips.com.

© Koninklijke Philips Electronics N.V. 2003

SCA75

All rights are reserved. Reproduction in whole or in part is prohibited without the prior written consent of the copyright owner.

The information presented in this document does not form part of any quotation or contract, is believed to be accurate and reliable and may be changed without notice. No liability will be accepted by the publisher for any consequence of its use. Publication thereof does not convey nor imply any license under patent- or other industrial or intellectual property rights.

Printed in The Netherlands

613524/03/pp15

Date of release: 2003 Sep 18

Document order number: 9397 750 11588

Let's make things better.

**Philips
Semiconductors**



PHILIPS

Mouser Electronics

Authorized Distributor

Click to View Pricing, Inventory, Delivery & Lifecycle Information:

[NXP:](#)

[BLF542,112](#)