

# CLEARCLOCK™ | POWER OPTIMIZED 0.12ps 5x7mm XO

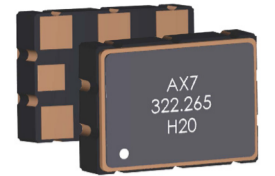

AX7

7.0 x 5.0 x 1.8 mm

RoHS/RoHS II Compliant

MSL = 1



ESD SENSITIVE

## FEATURES

- 0.125ps typ jitter (150fs MAX  $f > 200\text{MHz}$ , 25°C)
- Highest in-class frequency range from 50 to 2100MHz
- Excellent spurious suppression
- 70mA MAX  $I_{DD}$  (LVDS, any  $V_{DD}$ )
- Lowest in-class power consumption
- Supports LVPECL, HCSL, LVDS, CML
- Supports  $\pm 50\text{ppm}$  or  $\pm 100\text{ppm}$  all inclusive stability
- -40°C to 85°C or -20°C to 70°C operation
- Industry standard 5x7mm footprint

## APPLICATIONS

- Networking and communications
- RF systems, base stations (BTS)
- Test and measurement
- Cloud, server and storage, Fibre Channel
- 100/400GbEthernet
- PCI Express

## OPTIONS AND PART IDENTIFICATION [Note 1]

Note 1: Contact Abracon for part number requests with carrier frequency callouts up to 5 & 6 digit accuracy after the decimal.

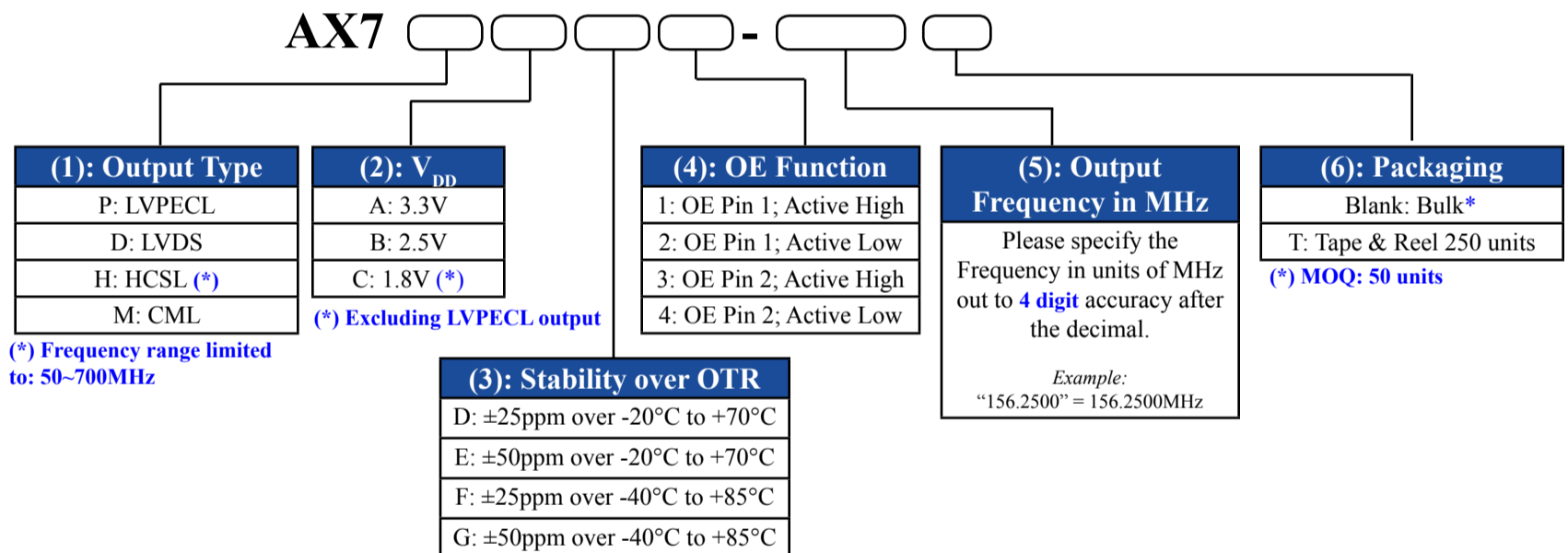

**Part Number Example:**  
**AX7PAF1-644.53125**

# CLEARCLOCK™ | POWER OPTIMIZED 0.12ps 5x7mm XO

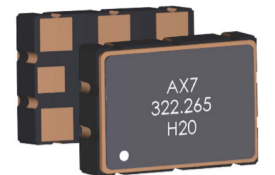

AX7

7.0 x 5.0 x 1.8 mm

RoHS/RoHS II Compliant

MSL = 1



ESD SENSITIVE

## COMMON KEY ELECTRICAL SPECIFICATIONS

| Parameters   |                 | Min.     | Typ.             | Max.             | Unit | Notes  |
|--|-----------------|----------|------------------|------------------|------|--|
| Frequency Range  | LVPECL          | 50       |                  | 2100             | MHz  | Option "P"   |
|  | LVDS            | 50       |                  | 2100             |      | Option "D"   |
|  | HCSL            | 50       |                  | 700              |      | Option "H"   |
|  | CML             | 50       |                  | 2100             |      | Option "M"   |
| Power Supply Voltage ( $V_{DD}$ ) <sup>[Note 1]</sup>                          |                 | 2.97     | 3.3              | 3.63             | V    | Option "A"   |
|  |                 | 2.25     | 2.5              | 2.75             |      | Option "B"   |
|  |                 | 1.71     | 1.8              | 1.89             |      | Option "C"   |
| Current Consumption ( $I_{DD}$ )   | LVPECL          |          | 87               | 94               | mA   | @ $V_{DD}=3.3V$  |
|  | LVDS            |          | 64               | 70               |      |  |
|  | HCSL            |          | 75               | 80               |      | @ $V_{DD}=1.8V$  |
|  | CML             |          | 63               | 68               |      |  |
| Set Tolerance (as received) @ 25°C ±3°C  |                 | -5.00    | <±3.00           | +5.00            | ppm  | Relative to carrier                                    |
| Operating Temperature Range (OTR)  |                 | -40      |                  | +85              | °C   | See Options  |
| Storage Temperature  |                 | -55      |                  | +155             | °C   |  |
| Frequency Stability over OTR   |                 | -25      |                  | +25              | ppm  | Option "D or F"  |
|  |                 | -50      |                  | +50              |      | Option "E or G"  |
| Aging over 10-Year Product Life <sup>[Note 2]</sup>                            |                 | -15      |                  | +15              | ppm  |  |
| All Inclusive Frequency Accuracy over 10-Year Product Life <sup>[Note 2]</sup> |                 | -50      |                  | +50              | ppm  | Specific to freq. stability option "D" or "F" (±25ppm) |
|  |                 | -100     |                  | +100             |      | Specific to freq. stability option "E" or "G" (±50ppm) |
| Rise (Tr) / Fall Time (Tf)   | LVPECL/LVDS/CML |          |                  | 0.35             | nS   | 20% ↔ 80% waveform                                     |
|  | HCSL            |          |                  | 0.40             |      |  |
| Duty Cycle   |                 | 45       |                  | 55               | %    | @ 50% $V_{DD}$   |
| Start-up Time <sup>[Note 2]</sup>  |                 |          | < 5.0            | 10               | ms   |  |
| Output High Voltage ( $V_{OH}$ )<br>Output Low Voltage ( $V_{OL}$ )            | LVPECL          | $V_{OH}$ | $V_{DD}-1.165$   | $V_{DD}-0.8$     | V    | 50Ω into $V_{DD}-2.0V$ or thevenin equivalent          |
|  |                 | $V_{OL}$ | $V_{DD}-2.0$     | $V_{DD}-1.55$    |      |  |
|  | LVDS            | $V_{OH}$ |                  | 1.4              |      | 100Ω between OUT and OUTN                              |
|  |                 | $V_{OL}$ | 0.9              | 1.1              |      |  |
|  | HCSL            | $V_{OH}$ | 0.66             | 1.15             |      | 50Ω to $V_{DD}$  |
|  |                 | $V_{OL}$ | 0.0              | 0.15             |      |  |
|  | CML             | $V_{OH}$ | $V_{DD}-0.085$   | $V_{DD}=Max$     |      | 50Ω into GND   |
|  |                 | $V_{OL}$ | $V_{DD}-0.6$     | $V_{DD}-0.32$    |      |  |
| Output Enable (OE) Control   |                 |          | 0.8*( $V_{DD}$ ) |                  | V    |  |
|  |                 |          |                  | 0.2*( $V_{DD}$ ) |      |  |

# CLEARCLOCK™ | POWER OPTIMIZED 0.12ps 5x7mm XO

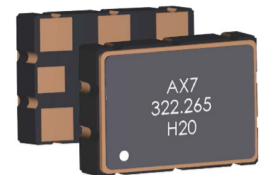

AX7

7.0 x 5.0 x 1.8 mm

RoHS/RoHS II Compliant

MSL = 1



ESD SENSITIVE

## COMMON KEY ELECTRICAL SPECIFICATIONS

| PARAMETERS                                | MIN.                     | TYP. | MAX. | UNIT | NOTES                   |
|---|--------------------------|------|------|------|-------------------------|
| Output Enable Time                        |                          |      | 2.5  | ms   |                         |
| Output Disable Time                       |                          |      | 10   | µs   |                         |
| Output Disable Current Consumption        | LVPECL                   | 85   | 86   | mA   | @ V <sub>dd</sub> =3.3V |
|   | LVDS                     | 63   | 65   |      |                         |
|   | HCSL                     | 77   | 78   |      | @ V <sub>dd</sub> =1.8V |
|   | CML                      | 62   | 67   |      |                         |
| <b>RMS Phase Jitter (12kHz -20MHz BW)</b> |                          |      |      |      |                         |
|   | 201.000MHz – 2100.000MHz | 125  | 150  | fsec | @ V <sub>dd</sub> =3.3V |
|   | 50.000MHz – 200.000MHz   | 200  | 300  |      |                         |
|   | 156.2500MHz              | ≤130 | 200  |      |                         |

Note 1: Supply Voltage (Vdd) = 1.8V option not available with LVPECL output

Note 2: Relative to initial measured frequency @ 25°C ±3°C

## TYPICAL PHASE NOISE AND JITTER CHARACTERISTICS (@25°C ± 3°C) [Note 2]

| Frequency (MHz)                                   | 148.35        | 150           | 155.52        | 156.25        | 156.25      | 200           | 212.5       | 312.5       |      |
|---|---------------|---------------|---------------|---------------|-------------|---------------|-------------|-------------|------|
| <b>RF Output</b>                                  | <b>LVDS</b>   | <b>LVPECL</b> | <b>LVPECL</b> | <b>LVPECL</b> | <b>HCSL</b> | <b>LVPECL</b> | <b>LVDS</b> | <b>LVDS</b> |      |
| <b>RMS Phase Jitter (fsec)<br/>12kHz-20MHz BW</b> | 125           | 137           | 124           | 123           | 129         | 122           | 127         | 114         |      |
| <b>Phase Noise (dBc/Hz)</b>                       | <b>100Hz</b>  | -96           | -98           | -98           | -98         | -99           | -90         | -83         | -94  |
|   | <b>1kHz</b>   | -120          | -120          | -120          | -121        | -121          | -114        | -114        | -115 |
|   | <b>10kHz</b>  | -132          | -132          | -132          | -132        | -132          | -129        | -129        | -126 |
|   | <b>100kHz</b> | -140          | -139          | -141          | -141        | -140          | -138        | -137        | -134 |
|   | <b>1MHz</b>   | -149          | -150          | -151          | -150        | -151          | -148        | -147        | -144 |
|   | <b>10MHz</b>  | -157          | -159          | -159          | -159        | -160          | -159        | -157        | -156 |
|   | <b>20MHz</b>  | -157          | -159          | -159          | -159        | -160          | -159        | -157        | -157 |

| Frequency (MHz)                                   | 322.265625    | 491.52      | 644.53125     | 1000          | 1244.16     | 1500        | 2100          |      |
|---|---------------|-------------|---------------|---------------|-------------|-------------|---------------|------|
| <b>RF Output</b>                                  | <b>LVPECL</b> | <b>HCSL</b> | <b>LVPECL</b> | <b>LVPECL</b> | <b>LVDS</b> | <b>LVDS</b> | <b>LVPECL</b> |      |
| <b>RMS Phase Jitter (fsec)<br/>12kHz-20MHz BW</b> | 121           | 121         | 123           | 127           | 114         | 127         | 138           |      |
| <b>Phase Noise (dBc/Hz)</b>                       | <b>100Hz</b>  | -91         | -92           | -91           | -77         | -76         | -78           | -77  |
|   | <b>1kHz</b>   | -113        | -114          | -111          | -107        | -102        | -102          | -98  |
|   | <b>10kHz</b>  | -125        | -125          | -122          | -119        | -115        | -113          | -108 |
|   | <b>100kHz</b> | -133        | -133          | -131          | -127        | -124        | -122          | -117 |
|   | <b>1MHz</b>   | -144        | -144          | -138          | -138        | -134        | -131          | -124 |
|   | <b>10MHz</b>  | -157        | -157          | -154          | -154        | -150        | -149          | -145 |
|   | <b>20MHz</b>  | -159        | -159          | -154          | -155        | -152        | -150          | -148 |

Note 2: Refer to following Section for selected Phase Noise Plots

# CLEARCLOCK™ | POWER OPTIMIZED 0.12ps 5x7mm XO

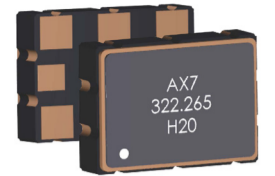

AX7

7.0 x 5.0 x 1.8 mm

RoHS/RoHS II Compliant

MSL = 1



ESD SENSITIVE

## SELECTED PHASE NOISE PLOTS (@25°C ± 3°C)

156.25MHz | LVPECL | V<sub>DD</sub>=3.3V

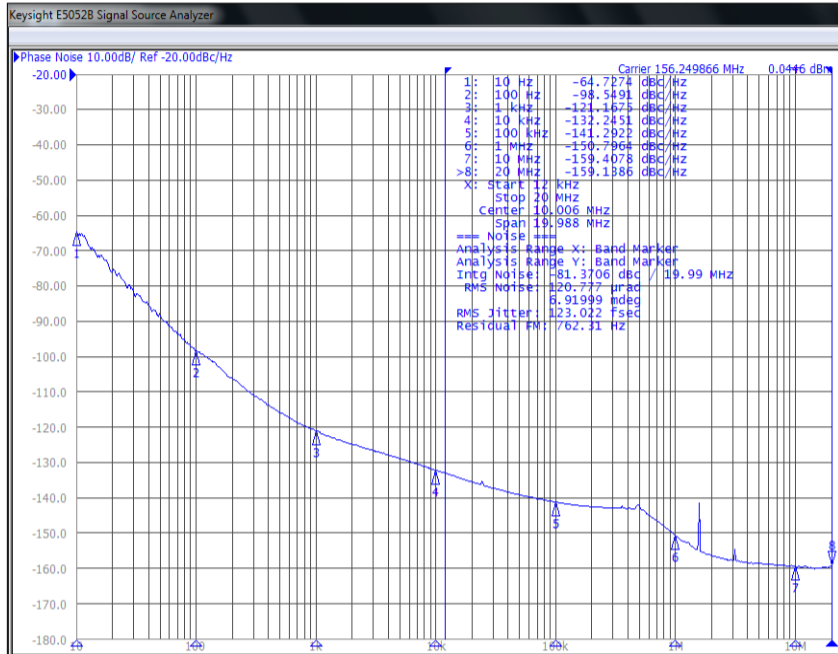

156.25MHz | HCSL | V<sub>DD</sub>=1.8V

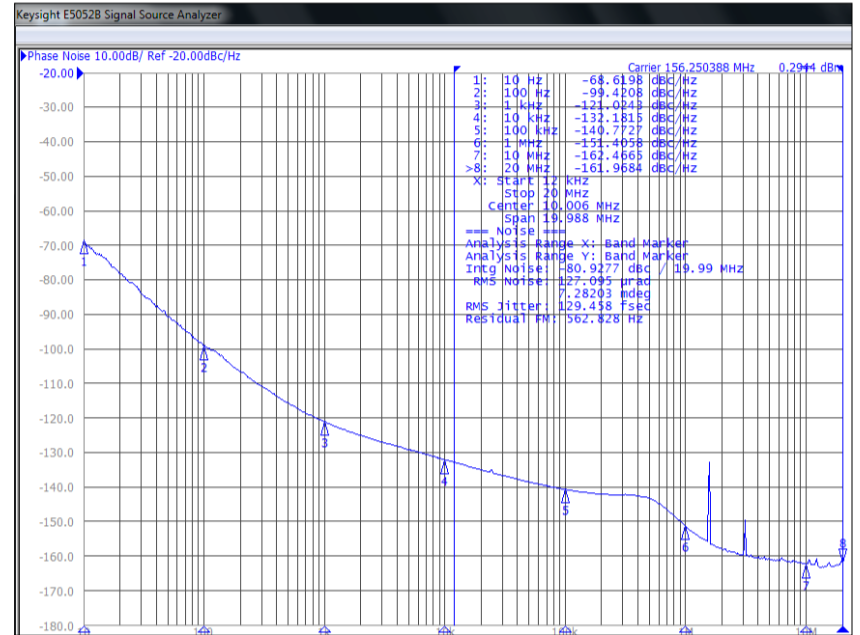

200MHz | LVPECL | V<sub>DD</sub>=3.3V

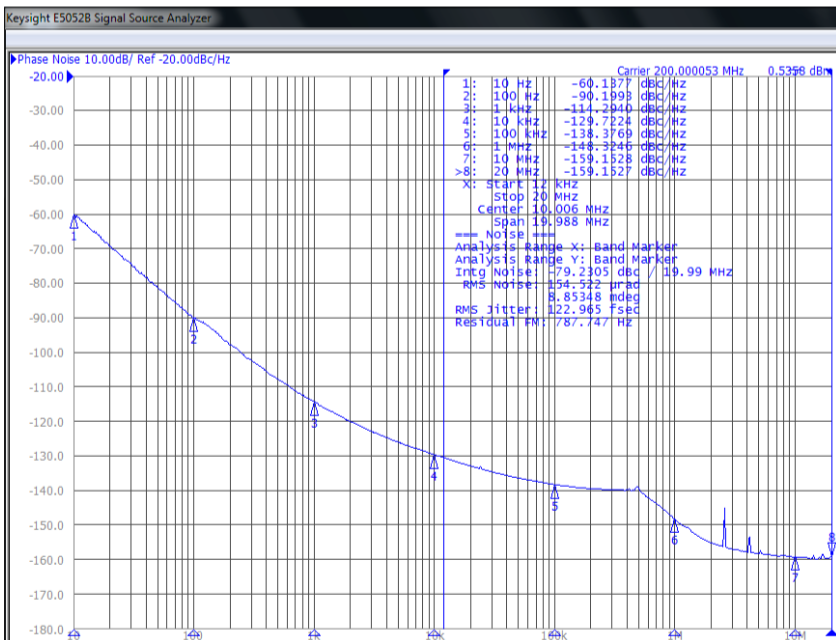

312.5MHz | LVDS | V<sub>DD</sub>=3.3V

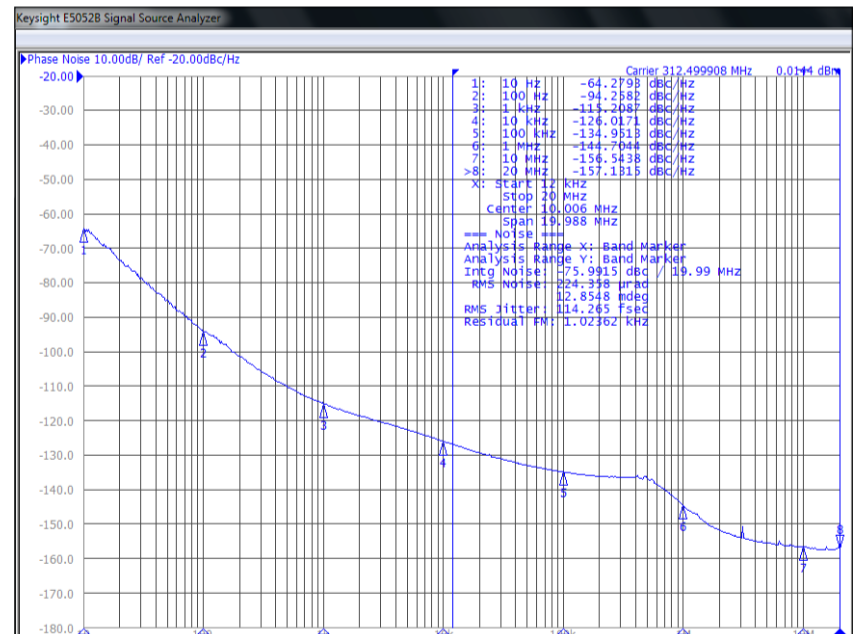

# CLEARCLOCK™ | POWER OPTIMIZED 0.12ps 5x7mm XO

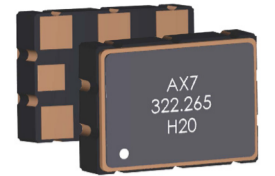

AX7

7.0 x 5.0 x 1.8 mm

RoHS/RoHS II Compliant

MSL = 1



ESD SENSITIVE

## SELECTED PHASE NOISE PLOTS (@25°C ± 3°C)

322.265625MHz | LVPECL |  $V_{DD}=3.3V$

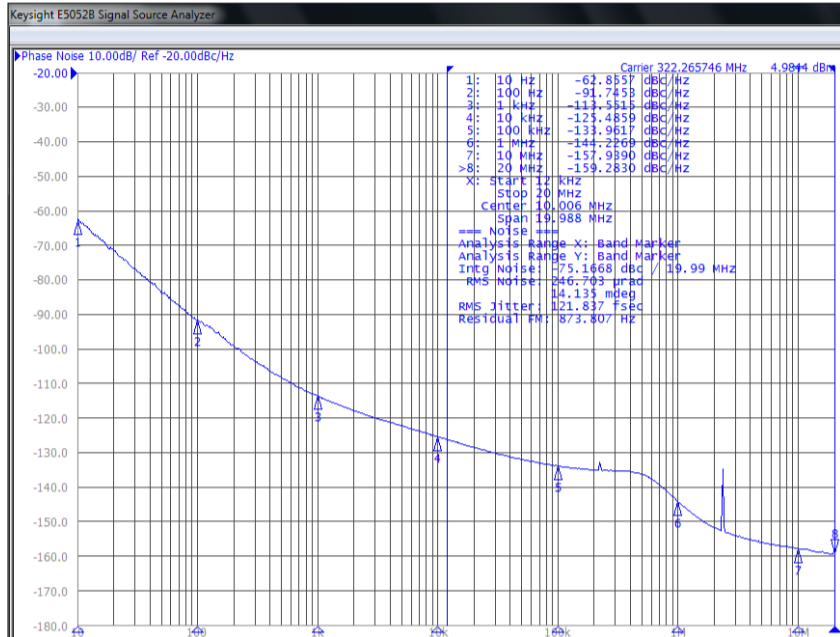

322.265625MHz | HCSL |  $V_{DD}=3.3V$

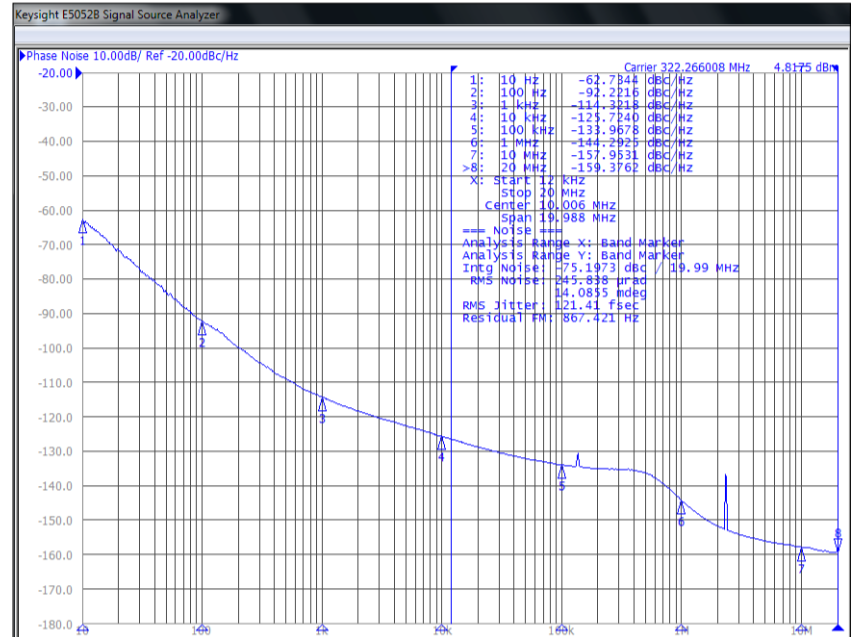

644.53125MHz | LVPECL |  $V_{DD}=3.3V$

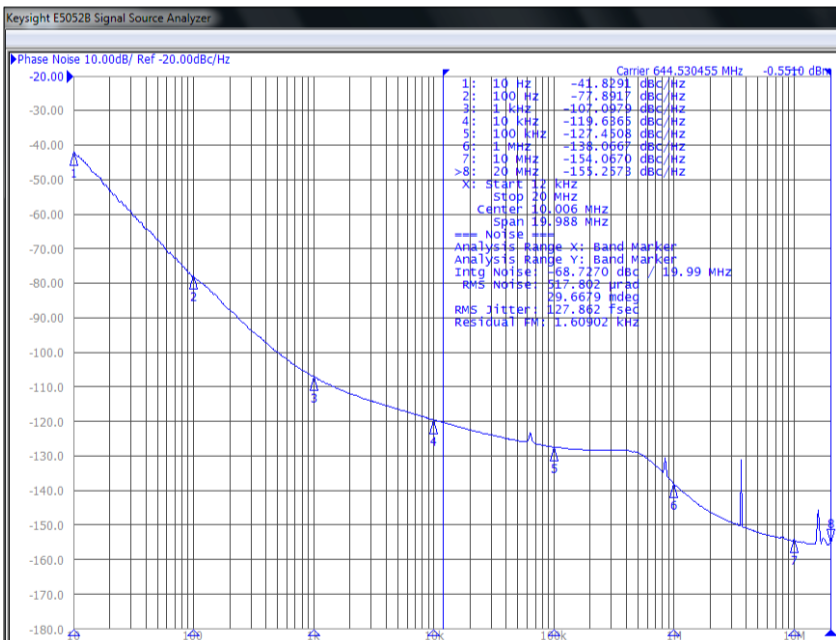

2100MHz | LVPECL |  $V_{DD}=3.3V$

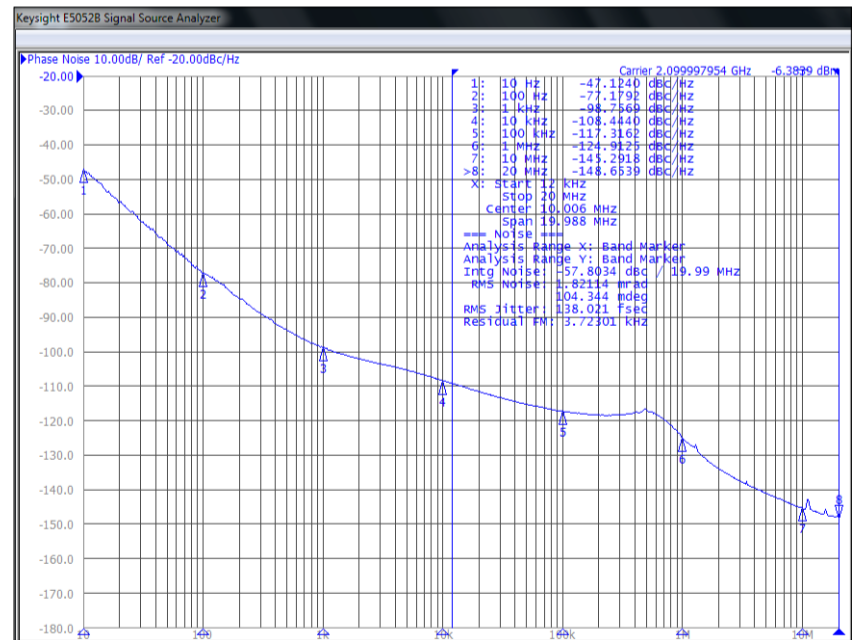

# CLEARCLOCK™ | POWER OPTIMIZED 0.12ps 5x7mm XO

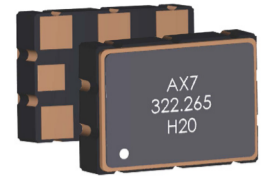

AX7

7.0 x 5.0 x 1.8 mm

RoHS/RoHS II Compliant

MSL = 1



ESD SENSITIVE

## TYPICAL FREQUENCY Vs. TEMPERATURE CHARACTERISTICS

## TYPICAL CURRENT CONSUMPTION ( $I_{DD}$ ) Vs. FREQUENCY CHARACTERISTICS (@ 25°C ± 3°C)

Frequency Stability vs. Temperature  
AX7PAF1-122.8800 (50 units)

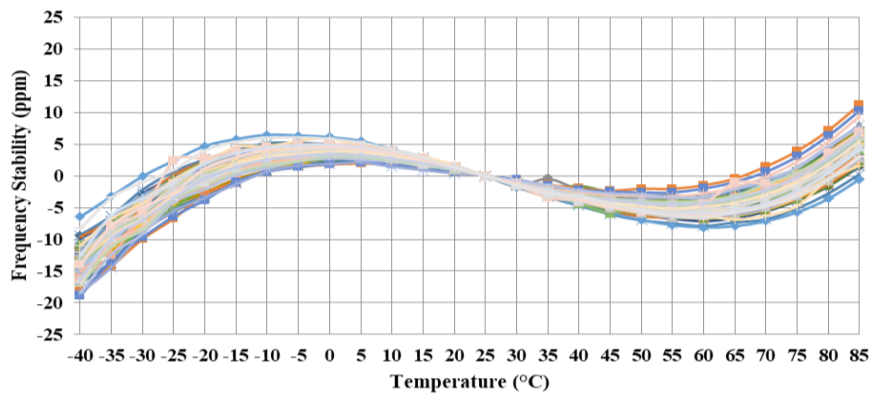

Current Consumption ( $I_{DD}$ ) vs. Frequency  
AX7

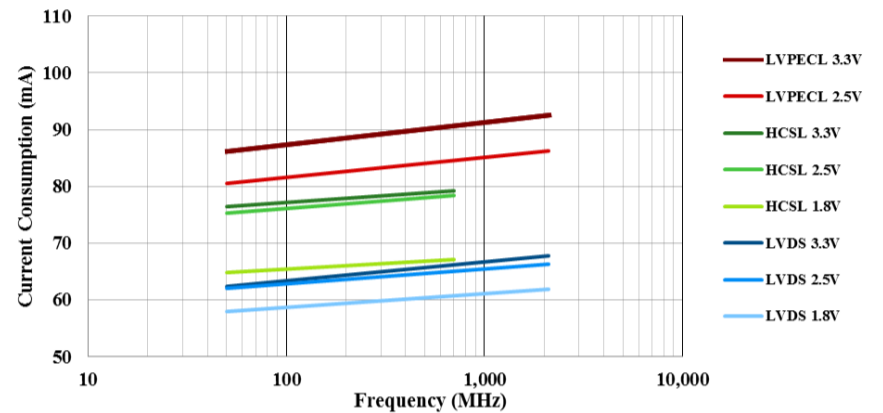

## MECHANICAL DIMENSIONS

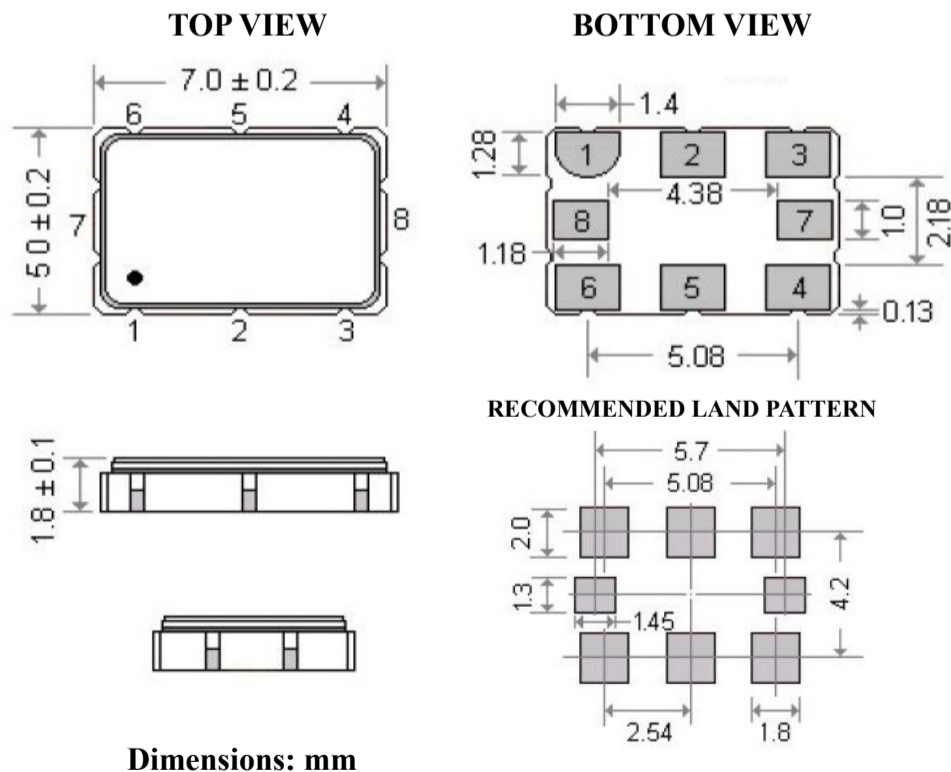

Dimensions: mm

| PIN # | FUNCTION   |
|-------|--|
| # 1   | <b>Option 1 &amp; 2:</b><br>Output Enable/ Disable<br><b>Option 3 &amp; 4:</b><br>No Connect |
| # 2   | <b>Option 1 &amp; 2:</b><br>No Connect<br><b>Option 3 &amp; 4:</b><br>Output Enable/ Disable |
| # 3   | GND  |
| # 4   | Output   |
| # 5   | Complementary output   |
| # 6   | Supply Voltage ( $V_{DD}$ )  |
| # 7   | No connect   |
| # 8   | No connect   |

\*Compatible with industry standard 5x7mm footprint. Pin 7 and 8 are no connect solder pads, not required.

# CLEARCLOCK™ | POWER OPTIMIZED 0.12ps 5x7mm XO

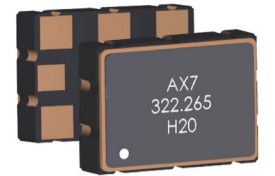

AX7

7.0 x 5.0 x 1.8 mm

RoHS/RoHS II Compliant

MSL = 1



ESD SENSITIVE

## RECOMMENDED TEST CIRCUIT

### LVDS

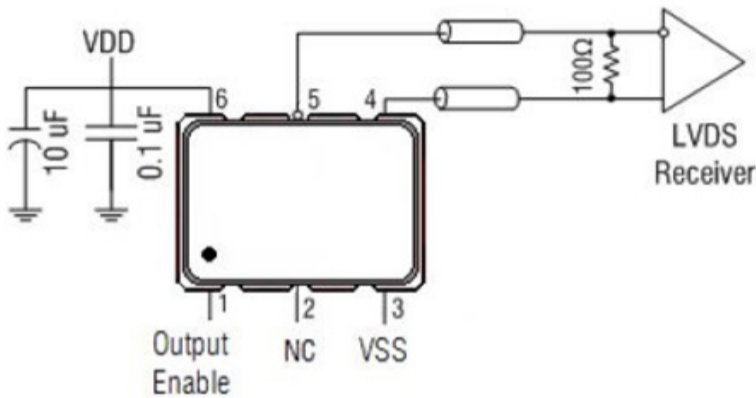

### HCSL

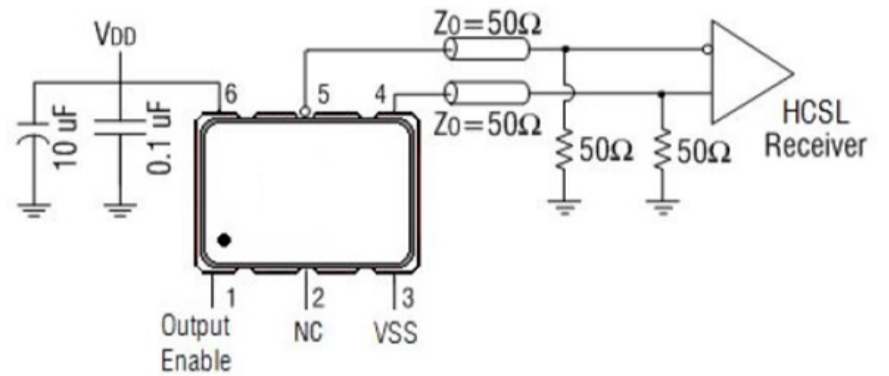

### LVPECL

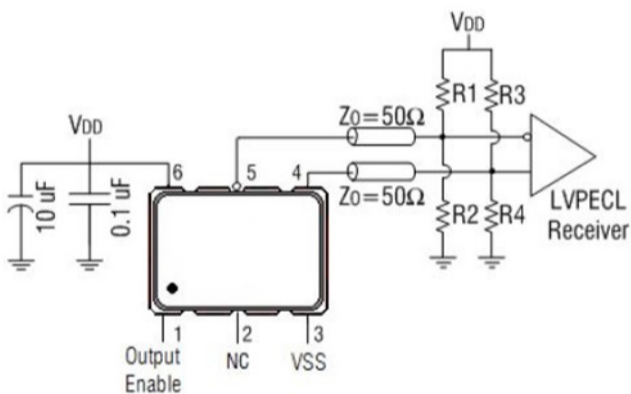

$V_{DD}=3.3V$ :  $R1=R3=127\Omega$ ;  $R2=R4=82.5\Omega$   
 $V_{DD}=2.5V$ :  $R1=R3=250\Omega$ ;  $R2=R4=62.5\Omega$

### CML

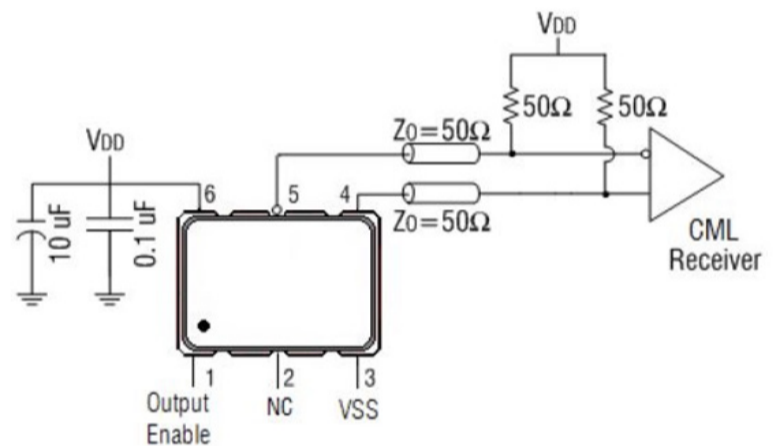

## DIFFERENTIAL OUTPUT WAVEFORM

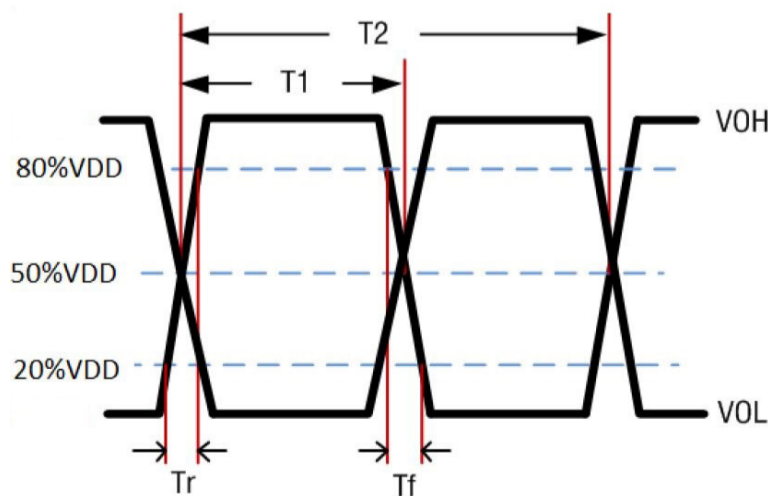

# CLEARCLOCK™ | POWER OPTIMIZED 0.12ps 5x7mm XO

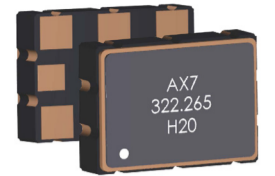

AX7

7.0 x 5.0 x 1.8 mm

RoHS/RoHS II Compliant

MSL = 1



ESD SENSITIVE

## REFLOW PROFILE

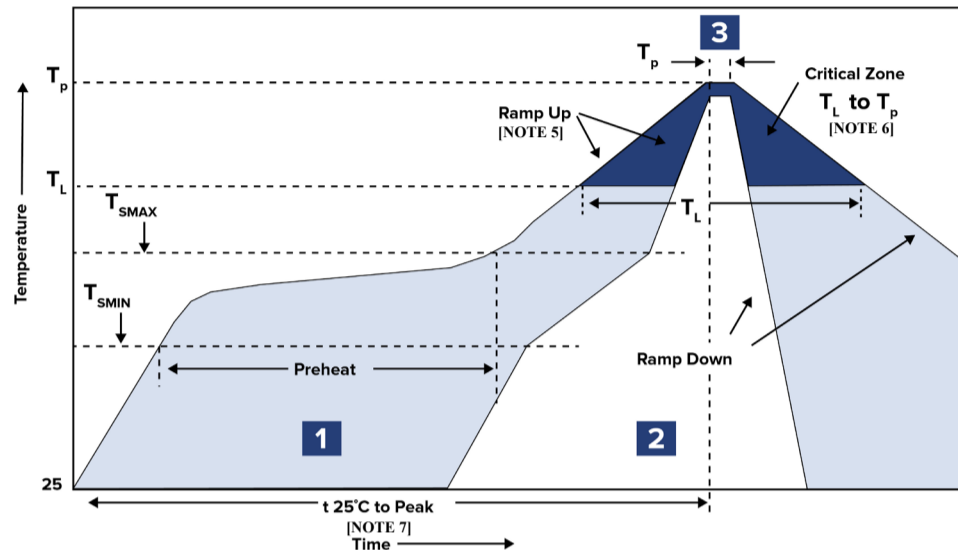

| ZONE | DESCRIPTION    | TEMPERATURE                               | TIME          |
|------|----------------|---|---------------|
| 1    | Preheat / Soak | $T_{SMIN} \sim T_{SMAX}$<br>150°C ~ 200°C | 60 ~ 180 sec. |
| 2    | Reflow         | $T_L$<br>217°C                            | 60 ~ 150 sec. |
| 3    | Peak heat      | $T_P$<br>260°C±5°C                        | 20 ~ 40 sec.  |

Note 5: Ramp Up Rate ( $T_L \rightarrow T_P$ ) = 3°C / sec. MAX

Note 6: Ramp Down Rate ( $T_P \rightarrow T_L$ ) = 6°C / sec. MAX

Note 7: Time 25°C to Peak Temperature (25°C →  $T_P$ ) = 8 minutes MAX

\*Can withstand 2 times reflow

\*All temperatures refer to topside of the package, measured on the package body surface

## PACKAGING

Blank = Bulk\*

T = Tape & Reel 250 units/reel

(\*) MOQ: 50 units

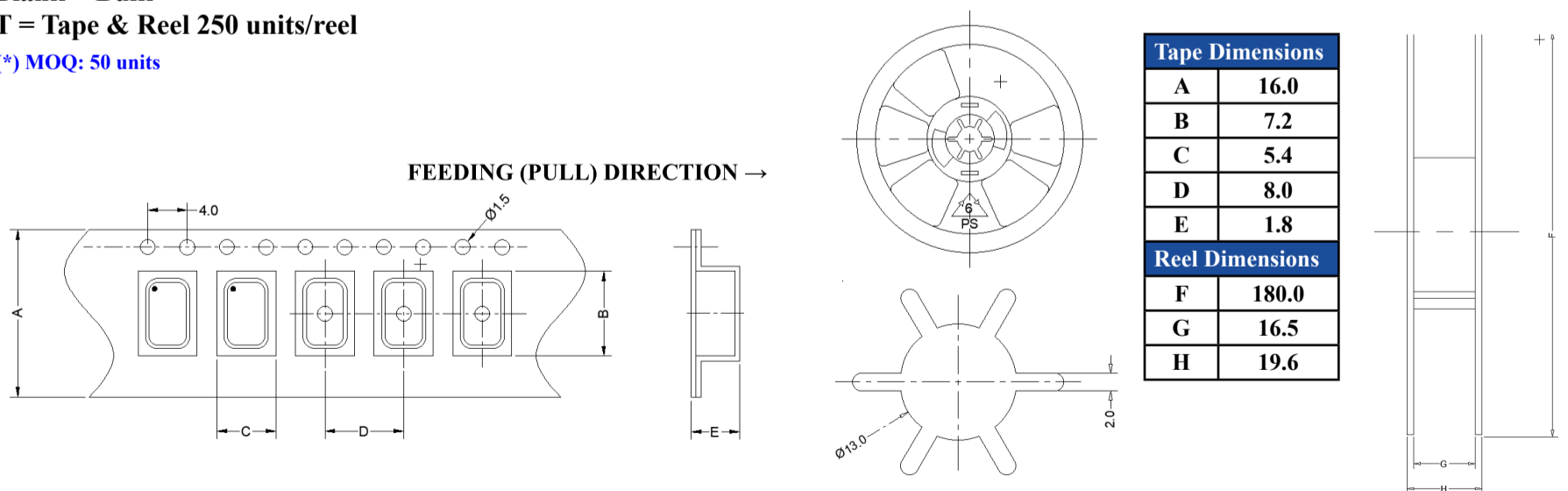

| Tape Dimensions |       |
|-----------------|-------|
| A               | 16.0  |
| B               | 7.2   |
| C               | 5.4   |
| D               | 8.0   |
| E               | 1.8   |
| Reel Dimensions |       |
| F               | 180.0 |
| G               | 16.5  |
| H               | 19.6  |

Dimensions: mm



5101 Hidden Creek Ln Spicewood TX 78669  
 Phone: 512-371-6159 | Fax: 512-351-8858  
 For terms and conditions of sale, please visit:  
[www.abracon.com](http://www.abracon.com)

REVISED: 04.17.2019

ABRACON IS  
 ISO9001-2015  
 CERTIFIED



# Mouser Electronics

Authorized Distributor

Click to View Pricing, Inventory, Delivery & Lifecycle Information:

## ABRACON:

[AX7MCF3-644.53125T](#) [AX7MBF1-644.5205C](#) [AX7PAF2-780.0000T](#) [AX7MAF1-2100.0000T](#) [AX7MBF1-312.5000C](#)  
[AX7PAF3-475.0000T](#) [AX7PAF2-983.0400C](#) [AX7DCF3-480.0000C](#) [AX7MCF1-349.3000T](#) [AX7DCF1-790.0000C](#)  
[AX7DCF3-187.5000T](#) [AX7MCF1-164.3555C](#) [AX7PBF2-491.5200T](#) [AX7PBF1-698.8123T](#) [AX7HBF1-175.0000C](#)  
[AX7PBF3-311.0400C](#) [AX7DAF1-1966.0800C](#) [AX7DBF1-66.6667C](#) [AX7MBF2-625.0000C](#) [AX7DAF1-614.0000C](#)  
[AX7MCF1-425.0000T](#) [AX7MCF1-61.4400T](#) [AX7DBF1-644.4563C](#) [AX7DBF2-1244.1600C](#) [AX7DBF3-1050.0000T](#)  
[AX7DCF1-622.0800T](#) [AX7DCF1-560.4000C](#) [AX7MBF4-368.6400C](#) [AX7DCF1-647.2394T](#) [AX7DCF4-250.0000T](#)  
[AX7PBF4-1100.0000T](#) [AX7DCF1-670.8386C](#) [AX7DAF2-720.0000T](#) [AX7MBF4-625.0000T](#) [AX7MBF1-614.4000T](#)  
[AX7DAF3-580.0000C](#) [AX7DBF1-753.0000C](#) [AX7PAF1-819.2000T](#) [AX7DBF2-466.5600T](#) [AX7PAF2-368.6400T](#)  
[AX7MAF1-700.0000T](#) [AX7PAF1-74.2500C](#) [AX7HBF1-350.0000C](#) [AX7MBF1-451.5840C](#) [AX7DBF3-800.0000T](#)  
[AX7MBF2-75.0000C](#) [AX7DCF1-320.0000T](#) [AX7PAF1-75.0000T](#) [AX7MAF1-657.4219C](#) [AX7PAF2-1050.0000C](#)  
[AX7DAF1-660.1842T](#) [AX7MCF4-1250.0000T](#) [AX7DAF1-460.8000C](#) [AX7HBF1-480.0000T](#) [AX7DCF1-1252.5000C](#)  
[AX7DCF1-869.2150C](#) [AX7PAF3-500.0000C](#) [AX7DAF1-1250.0000T](#) [AX7PAF1-156.2539T](#) [AX7DBF1-500.0000T](#)  
[AX7DAF2-475.0000C](#) [AX7MAF1-210.0000T](#) [AX7MAF1-172.6423C](#) [AX7MBF4-700.0000C](#) [AX7MCF3-640.0000T](#)  
[AX7DCF2-466.5600T](#) [AX7PBF1-914.0000T](#) [AX7MCF1-187.5000C](#) [AX7MCF1-266.6667T](#) [AX7MCF1-451.5840C](#)  
[AX7DAF4-1030.0000C](#) [AX7MCF3-960.0000C](#) [AX7MBF1-669.3266T](#) [AX7DAF1-368.6400T](#) [AX7DCF1-921.6000T](#)  
[AX7PAF2-450.0000C](#) [AX7DAF4-537.6000C](#) [AX7DBF1-1250.0000C](#) [AX7PBF1-771.8127C](#) [AX7PAF1-655.3600T](#)  
[AX7MAF1-629.8320C](#) [AX7PAF1-625.0000C](#) [AX7PAF3-1244.1600C](#) [AX7PAF1-212.5000C](#) [AX7DCF2-781.2500C](#)  
[AX7DBF1-725.0000C](#) [AX7MCF2-1100.0000T](#) [AX7DBF4-768.0000C](#) [AX7PAF3-77.7600T](#) [AX7DBF1-160.0000T](#)  
[AX7MAF1-575.0000T](#) [AX7MAF1-739.3153T](#) [AX7MBF2-622.0800C](#) [AX7DCF1-74.2500T](#) [AX7PBF1-1219.5000C](#)  
[AX7HBF1-620.0000T](#) [AX7MCF3-500.0000C](#) [AX7MBF1-2000.0000T](#) [AX7DCF4-725.0000T](#) [AX7PAF4-880.0000T](#)