

WIRE WOUND INDUCTOR - CERAMIC or FERRITE

AISC-0805(F)

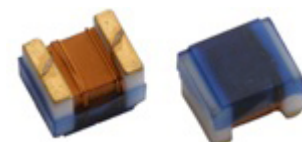

RoHS/RoHS II compliant



2.29 x 1.73 x 1.55mm

➤ **FEATURES:**

- Ceramic or Ferrite Construction assures the utmost in the thermal stability and high SRF
- Exceptionally high Q compared to non-wirewound inductor, especially at high frequencies
- Inductance values available from 2.2 nH to 68uH; tight tolerance

➤ **APPLICATIONS:**

- Widely applied in the VCO, SAW circuit for GSM, CDMA communications
- Used in hard disk, notebook computer and other electronic equipment

➤ **STANDARD SPECIFICATIONS:**

Part Number	L(nH) @Test Freq.	Tolerance (±%)	Q, Min @Test Freq.	SRF Min (MHz)	R _{dc} Max (Ω)	I _{dc} Max (mA)
AISC-0805-R0022	2.2 @ 250 MHz	10,20	40 @ 1500 MHz	>6000	0.10	600
AISC-0805-R0033	3.3 @ 250 MHz	5,10,20	30 @ 1500 MHz	>6000	0.08	600
AISC-0805-R0068	6.8 @ 250 MHz	5,10,20	40 @ 1000 MHz	5000	0.11	600
AISC-0805-R0082	8.2 @ 250 MHz	5,10,20	40 @ 1000 MHz	4600	0.19	600
AISC-0805-R012	12 @ 250 MHz	2,5,10,20	40 @ 500 MHz	4000	0.15	600
AISC-0805-R015	15 @ 250 MHz	5,10,20	40 @ 500 MHz	2900	0.17	600
AISC-0805-R018	18 @ 250 MHz	2,5,10,20	50 @ 500 MHz	3300	0.20	600
AISC-0805-R022	22 @ 250 MHz	2,5,10,20	55 @ 500 MHz	2000	0.22	500
AISC-0805-R027	27 @ 250 MHz	2,5,10,20	55 @ 500 MHz	2500	0.25	500
AISC-0805-R033	33 @ 250 MHz	2,5,10,20	60 @ 500MHz	2000	0.27	500
AISC-0805-R039	39 @ 250 MHz	2,5,10,20	60 @ 500MHz	2000	0.29	500
AISC-0805-R047	47 @ 200 MHz	2,5,10,20	50 @ 500MHz	1600	0.31	500
AISC-0805-R056	56 @ 200 MHz	2,5,10,20	55 @ 500MHz	1550	0.32	500
AISC-0805-R068	68 @ 200 MHz	2,5,10,20	55 @ 500MHz	1450	0.38	500
AISC-0805-R082	82 @ 150 MHz	2,5,10,20	50 @ 500MHz	1300	0.42	400
AISC-0805-R10	100 @ 150 MHz	2,5,10,20	50 @ 500MHz	1200	0.46	400
AISC-0805-R12	120 @ 150 MHz	2,5,10,20	50 @ 250 MHz	1100	0.51	400
AISC-0805-R15	150 @ 100 MHz	2,5,10,20	50 @ 250 MHz	920	0.56	400
AISC-0805-R18	180 @ 100 MHz	2,5,10,20	50 @ 250 MHz	870	0.64	400
AISC-0805-R22	220 @ 100 MHz	2,5,10,20	45 @ 250 MHz	850	1.10	400
AISC-0805-R27	270 @ 100 MHz	2,5,10,20	38 @ 250 MHz	650	1.00	350
AISC-0805-R33	330 @ 100 MHz	2,5,10,20	40 @ 250 MHz	600	1.4	310
AISC-0805-R39	390 @ 100 MHz	2,5,10,20	35 @ 250 MHz	560	1.5	290
AISC-0805-R47	470 @ 50 MHz	5,10,20	33 @ 100 MHz	375	1.72	250
AISC-0805-R56	560 @ 25 MHz	5,10,20	23 @ 50 MHz	320	1.9	230
AISC-0805-R62	620 @ 25 MHz	5,10,20	23 @ 50 MHz	280	1.95	200
AISC-0805-R68	680 @ 25 MHz	5,10,20	23 @ 50 MHz	270	2.05	190
AISC-0805-R75	750 @ 25 MHz	5,10,20	23 @ 50 MHz	240	2.1	180
AISC-0805-R82	820 @ 25 MHz	5,10,20	23 @ 50 MHz	250	2.3	180
AISC-0805-R91	910 @ 25 MHz	5,10,20	22 @ 50 MHz	230	2.4	160
AISC-0805-1R0	1000 @ 25 MHz	5,10,20	20 @ 50 MHz	200	2.5	150
AISC-0805F-R27	270@25MHz	5,10,20	15@25MHz	550	0.91	350
AISC-0805F-R47	470@100MHz	5,10,20	8@100MHz	500	0.72	300
AISC-0805F-R56	560@25MHz	5,10,20	15@25MHz	360	0.6	145
AISC-0805F-1R0	1000@7.9MHz	2,5,10,20	15@7.9MHz	63	1.20	245
AISC-0805F-1R5	1500@7.9MHz	2,5,10,20	15@7.9MHz	60	1.45	225
AISC-0805F-1R8	1800@7.9MHz	5,10,20	15@7.9MHz	60	1.45	200
AISC-0805F-2R2	2200@7.9MHz	2,5,10,20	10@50MHz	200	2.50	100
AISC-0805F-3R3	3300@7.9MHz	2,5,10,20	15@7.9MHz	50	2.30	175
AISC-0805F-3R9	3900@7.9MHz	5,10,20	10@7.9MHz	50	2.50	80
AISC-0805F-4R7	4700@7.9MHz	2,5,10,20	15@7.9MHz	43	2.80	140
AISC-0805F-6R8	6800@7.9MHz	2,5,10,20	15@7.9MHz	36	3.40	115
AISC-0805F-8R2	8200@7.9MHz	5,10,20	10@2.5MHz	35	4.50	100

PARAMETERS

ABRACON P/N:
AISC-0805(F)-xxx

Operating temperature:
-40°C to +125°C

Storage temperature:
-10°C to +40°C
70% RH max.

WIRE WOUND INDUCTOR - CERAMIC or FERRITE

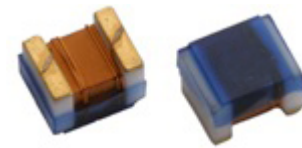

2.29 x 1.73 x 1.55mm

AISC-0805(F)



RoHS/RoHS II compliant

Part Number	L(nH) @Test Freq.	Tolerance (±%)	Q, Min @Test Freq.	SRF Min (MHz)	R _{DC} Max (Ω)	I _{DC} Max (mA)
AISC-0805F-100	10000@2.5MHz	2,5,10,20	10@2.5MHz	30	4.70	98
AISC-0805F-150	15000@2.5MHz	2,5,10,20	10@2.5MHz	23	6.50	80
AISC-0805F-220	22000@2.5MHz	2,5,10,20	10@2.5MHz	20	8.00	68
AISC-0805F-330	33000@2.5MHz	2,5,10,20	10@2.5MHz	17	10.7	60
AISC-0805F-470	47000@2.5MHz	2,5,10,20	10@2.5MHz	14	13.8	55
AISC-0805F-680	68000@2.5MHz	2,5,10,20	8@2.5MHz	11	17.5	40

Test Conditions

Inductance (L): Agilent4287A+Agilent16197A or equivalent, 50mV

Direct Current Resistance (DCR): HIOKI 3540 or equivalent

Temperature rise current (I_r): Electric Power, Electric current meter, Thermometer

I_{DC}: Based on temperature rise (ΔT: 20°C)

PART IDENTIFICATION:

AISC-0805 - - -

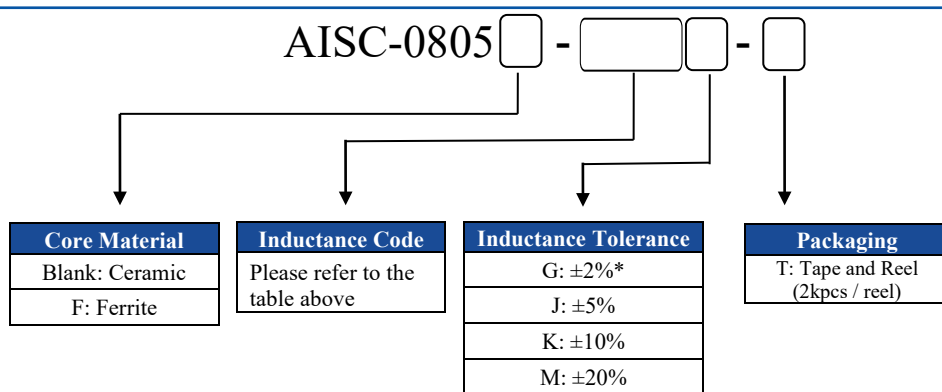

*Please review electrical specification table

OUTLINE DRAWING:

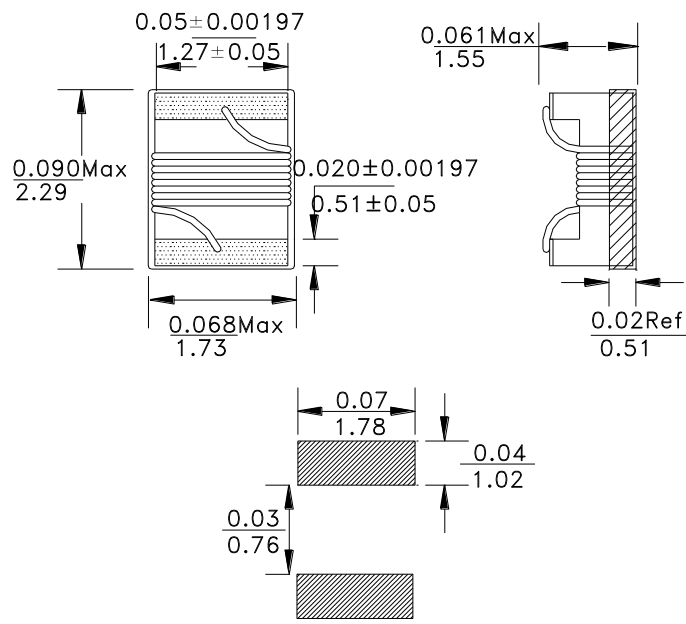

Recommended Land Pattern

Dimension: inches / mm

WIRE WOUND INDUCTOR - CERAMIC or FERRITE

AISC-0805(F)



RoHS/RoHS II compliant

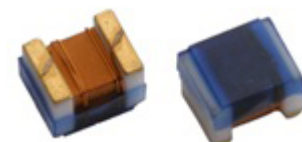

2.29 x 1.73 x 1.55mm

REFLOW PROFILE:

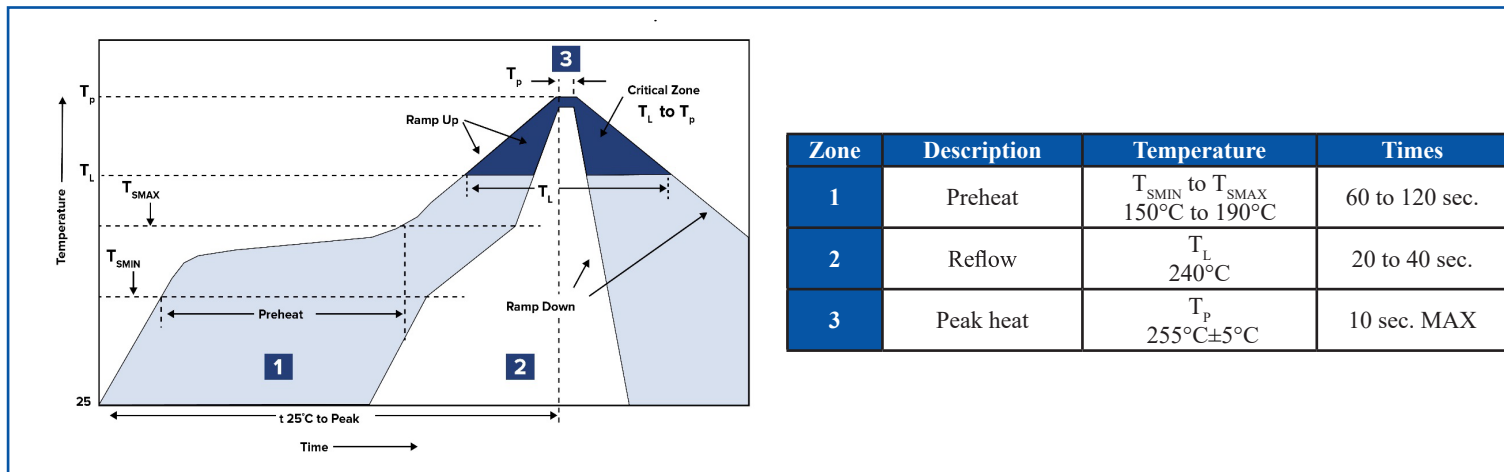

TAPE & REEL:

T= tape and reel (2,000pcs/reel)

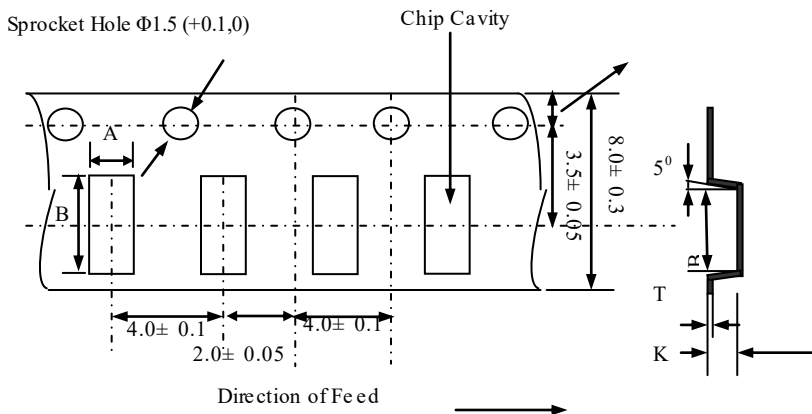

Type	A	B	K	T
2012	1.88±0.2	2.4±0.2	1.35±0.2	0.22±0.1

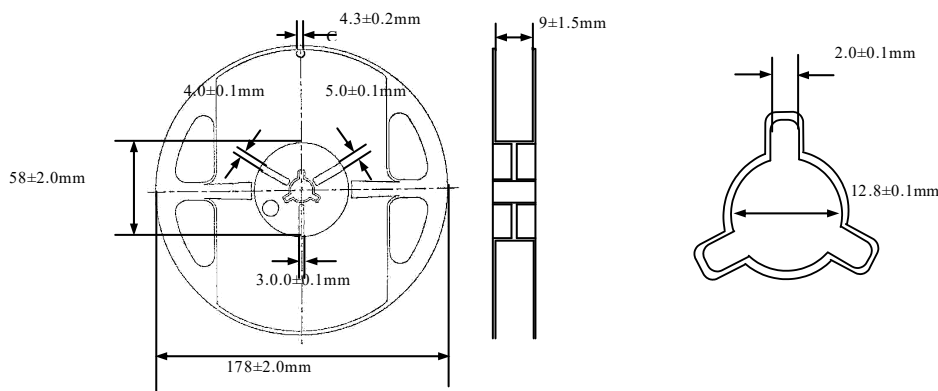

Dimension: mm

ATTENTION: Abracon LLC's products are COTS – Commercial-Off-The-Shelf products; suitable for Commercial, Industrial and, where designated, Automotive Applications. Abracon's products are not specifically designed for Military, Aviation, Aerospace, Life-dependant Medical applications or any application requiring high reliability where component failure could result in loss of life and/or property. For applications requiring high reliability and/or presenting an extreme operating environment, written consent and authorization from Abracon LLC is required. Please contact Abracon LLC for more information.

Mouser Electronics

Authorized Distributor

Click to View Pricing, Inventory, Delivery & Lifecycle Information:

ABRACON:

[AISC-0805-R0022K](#) [AISC-0805-R022K](#) [AISC-0805-1R0G-T](#) [AISC-0805F-100G-T](#) [AISC-0805F-150G-T](#) [AISC-0805F-1R0G-T](#) [AISC-0805F-1R5G-T](#) [AISC-0805F-220G-T](#) [AISC-0805F-2R2G-T](#) [AISC-0805F-330G-T](#) [AISC-0805F-3R3G-T](#) [AISC-0805F-470G-T](#) [AISC-0805F-4R7G-T](#) [AISC-0805F-680G-T](#) [AISC-0805F-6R8G-T](#) [AISC-0805-R012G-T](#) [AISC-0805-R015G-T](#) [AISC-0805-R018G-T](#) [AISC-0805-R022G-T](#) [AISC-0805-R027G-T](#) [AISC-0805-R033G-T](#) [AISC-0805-R039G-T](#) [AISC-0805-R047G-T](#) [AISC-0805-R056G-T](#) [AISC-0805-R068G-T](#) [AISC-0805-R082G-T](#) [AISC-0805-R10G-T](#) [AISC-0805-R12G-T](#) [AISC-0805-R15G-T](#) [AISC-0805-R18G-T](#) [AISC-0805-R22G-T](#) [AISC-0805-R27G-T](#) [AISC-0805-R33G-T](#) [AISC-0805-R39G-T](#) [AISC-0805-R47G-T](#) [AISC-0805-R56G-T](#) [AISC-0805-R68G-T](#) [AISC-0805-R82G-T](#) [AISC-0805-R068J-T](#) [AISC-0805F-6R8J-T](#) [AISC-0805-R0022J-T](#) [AISC-0805-R47J-T](#) [AISC-0805-R027J-T](#) [AISC-0805-R082J-T](#) [AISC-0805-R82J-T](#) [AISC-0805F-1R5J-T](#) [AISC-0805F-150J-T](#) [AISC-0805-R56J-T](#) [AISC-0805F-330J-T](#) [AISC-0805-R22J-T](#) [AISC-0805F-2R2J-T](#) [AISC-0805F-470J-T](#) [AISC-0805-R047J-T](#) [AISC-0805-R15J-T](#) [AISC-0805F-220J-T](#) [AISC-0805-R39J-T](#) [AISC-0805-1R0J-T](#) [AISC-0805-R18J-T](#) [AISC-0805-R12J-T](#) [AISC-0805-R0033J-T](#) [AISC-0805-R33J-T](#) [AISC-0805-R015J-T](#) [AISC-0805F-680J-T](#) [AISC-0805F-4R7J-T](#) [AISC-0805F-3R3J-T](#) [AISC-0805-R033J-T](#) [AISC-0805-R68J-T](#) [AISC-0805-R056J-T](#) [AISC-0805-R018J-T](#) [AISC-0805-R27J-T](#) [AISC-0805-R012J-T](#) [AISC-0805F-1R0J-T](#) [AISC-0805-R10J-T](#) [AISC-0805-R0082J-T](#) [AISC-0805F-100J-T](#) [AISC-0805-R039J-T](#) [AISC-0805-R022J-T](#) [AISC-0805-R0068J-T](#) [AISC-0805-R0022K-T](#)