

Real Time Clock Module with I²C Bus

AB-RTCMC-32.768kHz-B5GA-S3

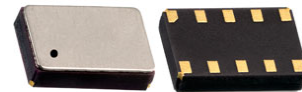

RoHS/RoHS II compliant



3.7 x 2.5 x 0.9 mm

Moisture Sensitivity Level: MSL=1

FEATURES:

- With state-of-the-art RTC Technology by Micro Crystal AG
- RTC module with built-in crystal oscillating at 32.768 kHz
- 400kHz two-wire I2C interface
- Wide Interface operating voltage: 1.8 – 5.5 V
- Wide clock operating voltage: 1.2 – 5.5 V
- Low power consumption: 250 nA typ @ 3.0V / 25°C
- Provides year, month, day, weekday, hours, minutes, seconds
- Alarm and Timer functions
- Century flag
- Low voltage detector, internal power on reset
- Programmable clock output for peripheral devices (32.768 kHz, 1024 Hz, 32 Hz, 1 Hz)
- I2C slave address: read A3h, write A2h
- Small and compact package size: 3.7 x 2.5 x 0.9 mm. RoHS-compliant and 100% leadfree

APPLICATIONS:

- Wide range in communication & measuring equipment
- Commercial & Industrial applications
- Automotive electronics applications
- Wireless communications
- PDA and Palm Pilots
- Credit Cards with Security Technology

STANDARD SPECIFICATIONS:

Absolute Maximum Ratings

Parameters	Min.	Typ.	Max.	Units	Notes
Supply Voltage (V_{DD})	-0.5		+6.5	V	>GND / < V_{DD}
Supply Current (I_{DD} ; I_{SS})	-50		+50	mA	V_{DD} Pin
Input Voltage (V_I)	$V_{SS}-0.5$		$V_{DD}+0.5$	V	Input Pin
Output Voltage (V_O)	$V_{SS}-0.5$		$V_{DD}+0.5$	V	\overline{INT} Pin
DC Input Current (I_I)	-10		+10	mA	
DC Output Current (I_O)	-10		+10	mA	
Operating Temperature Range (T_{OPR})	-40		+85	°C	
Storage Temperature (T_{STO})	-55		+125	°C	Stored as bare product

Frequency Characteristics

Parameters	Min.	Typ.	Max.	Units	Notes
Frequency Accuracy ($\Delta F/F$)		±10	±20	ppm	$T_{AMB}=+25^{\circ}C$; $V_{DD}=3.0V$
Frequency vs Voltage ($\Delta F/V$)		±0.8	±1.5	ppm/V	$T_{AMB}=+25^{\circ}C$; $V_{DD}=1.8\sim 5.5V$
Frequency vs Temperature ($\Delta F/T_{OPR}$)	-0.035ppm/°C ² ($T_{OPR}-T_O$) ² ±10%			ppm	$T_{REF}=+25^{\circ}C$; $V_{DD}=3.0V$
Turnover Temperature (T_O)	+20	+25	+30	°C	
Aging (first year)	-3		+3	ppm	$T_{AMB}=+25^{\circ}C$
Start-up Time (T_{START})		350	500	ms	$T_{AMB}=+25^{\circ}C$
CLKOUT duty cycle	40	50	60	%	$T_{AMB}=+25^{\circ}C$

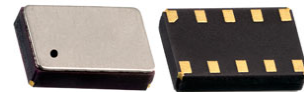

Static Characteristics

Parameters		Min.	Typ.	Max.	Units	Notes
Supplies						
Supply Voltage (V _{DD})		1.2		5.5	V	I ² C bus inactive T _{AMB} =+25°C
		1.8		5.5		I ² C bus active f _{SCL} = 400kHz
		V _{LOW}		5.5		For clock data integrity T _{AMB} =+25°C
Current Consumption (I _{DD0})	f _{SCL} = 400kHz			800	μA	I ² C bus active
	f _{SCL} = 100kHz			200		
Current Consumption (I _{DD}) ^{1) 2) 3)}	V _{DD} = 5.0V		275	550	nA	I ² C bus inactive(f _{SCL} =0Hz) CLKOUT disabled T _{AMB} =+25°C
	V _{DD} = 3.0V		250	500		
	V _{DD} = 2.0V		225	450		
Current Consumption (I _{DD}) ^{1) 2) 3)}	V _{DD} = 5.0V		500	750	nA	I ² C bus inactive(f _{SCL} =0Hz) CLKOUT disabled T _{AMB} =-40 ~ +85°C
	V _{DD} = 3.0V		400	650		
	V _{DD} = 2.0V		400	600		
Current Consumption (I _{DD32k}) ³⁾	V _{DD} = 5.0V		2.5	3.4	μA	I ² C bus inactive(f _{SCL} =0Hz) CLKOUT enabled (32.768kHz) Load=7.5pF / T _{AMB} = +25°C
	V _{DD} = 3.0V		1.5	2.2		
	V _{DD} = 2.0V		1.1	1.6		
Input						
LOW Level Input Voltage (V _{IL})		V _{SS} -0.5		30%* V _{DD}	V	
HIGH Level Input Voltage (V _{IH})		70%* V _{DD}		V _{DD} +0.5	V	
Input Leakage Current (I _L)		-1		+1	μA	V _I =V _{DD} or V _{SS}
Input Capacitance (C _I) ⁴⁾				7	pF	
Output						
HIGH Level Output Current (I _{OH})	Pin: CLKOUT			1	mA	V _{OH} = 4.6V; V _{DD} = 5.0V
LOW Level Output Current (I _{OL})	Pin: SDA			-3	mA	V _{OL} = 0.4V; V _{DD} = 5.0V
	Pin: $\overline{\text{INT}}$			-1		
	Pin: CLKOUT			-1		
Output Leakage Current (I _{LO})		-1	0	+1	μA	V _O = V _{DD} or V _{SS}
Voltage Detector						
Low Voltage (V _{LOW})			0.9	1.0	V	T _{AMB} =+25°C

1) Timer source clock = 1/60 Hz.

2) CLKOUT disabled (FE = 0 or CLKOE = 0).

3) V_{IL} and V_{IH} with an input voltage swing of V_{SS} to V_{DD}.

4) Tested on sample basis.

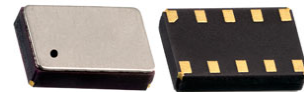

I²C Interface Dynamic Characteristics

All timing values are valid within the operating supply voltage range and references to V_{IL} and V_{IH} with an input voltage swing from V_{SS} and V_{DD} .

Parameters	Min.	Typ.	Max.	Units
SCL clock frequency (f_{SCL})			400	kHz
Hold time (repeated) START condition ($t_{HD,STA}$)	0.6			μ s
Startup time for repeated START condition ($t_{SU,STA}$)	0.6			μ s
LOW period of SCL clock (t_{LOW})	1.3			μ s
HIGH period of SCL clock (t_{HIGH})	0.6			μ s
Bus free time between STOP and START condition (t_{BUF})	1.3			μ s
Rise time of both SDA and SCL signals (t_r)			0.3	μ s
Fall time of both SDA and SCL signals (t_f)			0.3	μ s
Capacitive load for each bus line (C_b)			400	pF
Data setup time ($t_{SU,DAT}$)	100			ns
Data hold time ($t_{HD,DAT}$)	0			ns
Setup time for STOP condition ($t_{SU,STO}$)	0.6			μ s
Spike pulse width ($t_{w(spike)}$)			50	ns

I²C Interface Timing Characteristics

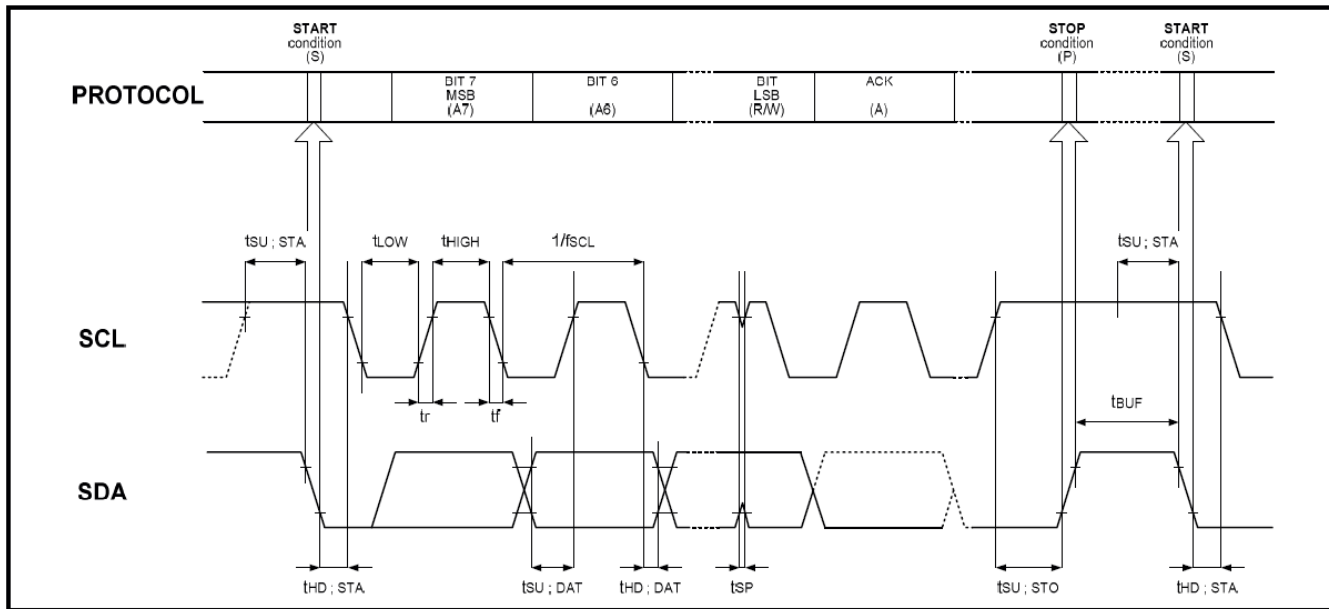

Note:

The I²C BUS access time between a START and a START condition or between a START and a STOP condition to this device must be less than one second.

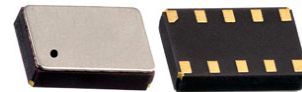

3.7 x 2.5 x 0.9 mm

AB-RTCMC-32.768kHz-B5GA-S3



RoHS/RoHS II compliant

PART IDENTIFICATIONS:

AB-RTCMC-32.768 kHz-B5GA-S3-

Packaging

Blank: Bulk

T: 1000pcs/reel

OUTLINE DIMENSIONS:

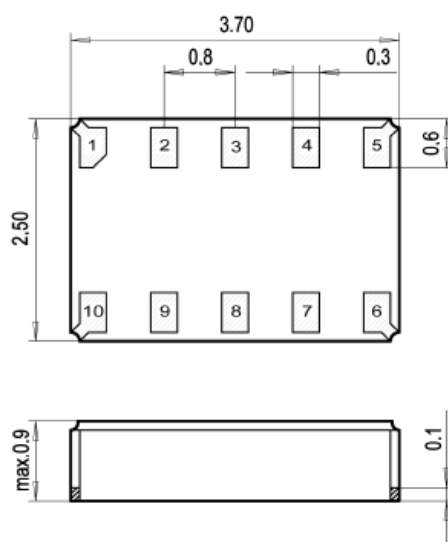

Recommended Land Pattern

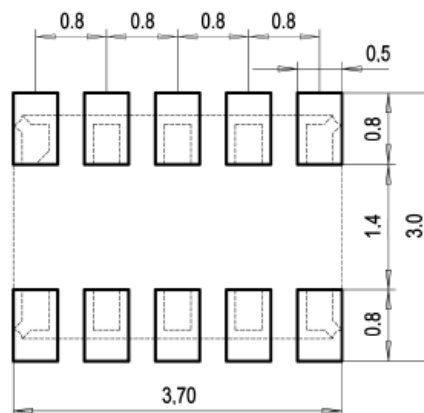

Dimensions: mm

PIN DESCRIPTIONS:

Pin No.	Pin Name	Function
1	CLKOE	CLKOUT enable/disable pin; enable is active HIGH; tie to GND when not using CLKOUT
2	V _{DD}	Positive supply voltage
3	CLKOUT	Clock Output pin; push-pull
4	SCL	Serial Clock Input pin; requires pull-up resistor
5	SDA	Serial Data Input-Output pin; open-drain; requires pull-up resistor
6	$\overline{\text{INT}}$	Interrupt Output pin; open-drain; active LOW
7	V _{SS}	Ground
8	N.C.	Not Connected
9	N.C.	Not Connected
10	N.C.	Not Connected

Real Time Clock Module with I²C Bus

AB-RTCMC-32.768kHz-B5GA-S3



RoHS/RoHS II compliant

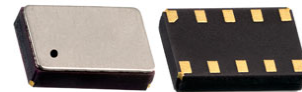

3.7 x 2.5 x 0.9 mm

BLOCK DIAGRAM:

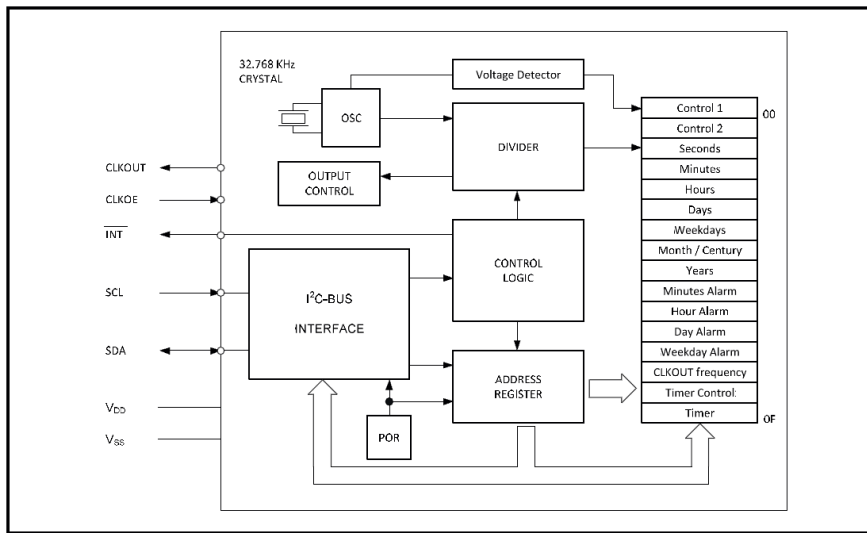

RECOMMENDED REFLOW PROFILE:

Maximum Reflow Conditions in accordance with IPC/JEDEC J-STD-020C "Pb-free"

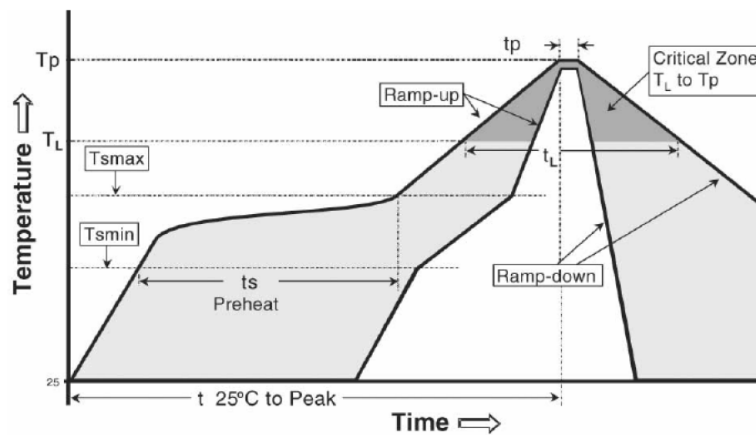

Temperature	Conditions	Units
Average Ramp-up Rate (T_{Smax} to T_p)	3°C/second max	°C/s
Ramp Down Rate (T_{cool})	6°C/second max	°C/s
Time 25°C to Peak Temperature ($T_{to-peak}$)	8 minutes max	m
Preheat		
Temperature Min (T_{Smin})	150	°C
Temperature Max (T_{Smax})	200	°C
Time T_{Smin} to T_{Smax} (t_s)	60 ~ 180	sec
Time Above Liquidus		
Temperature Liquidus (T_L)	217	°C
Time above Liquidus (t_L)	60 ~ 150	sec
Peak Temperature		
Peak Temperature (T_p)	260	°C
Time within 5°C of Peak Temperature (t_p)	20 ~ 40	sec

Real Time Clock Module with I²C Bus

AB-RTCMC-32.768kHz-B5GA-S3



RoHS/RoHS II compliant

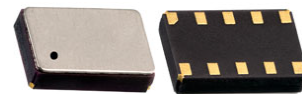

3.7 x 2.5 x 0.9 mm

TAPE & REEL:

T = 1000pcs/reel

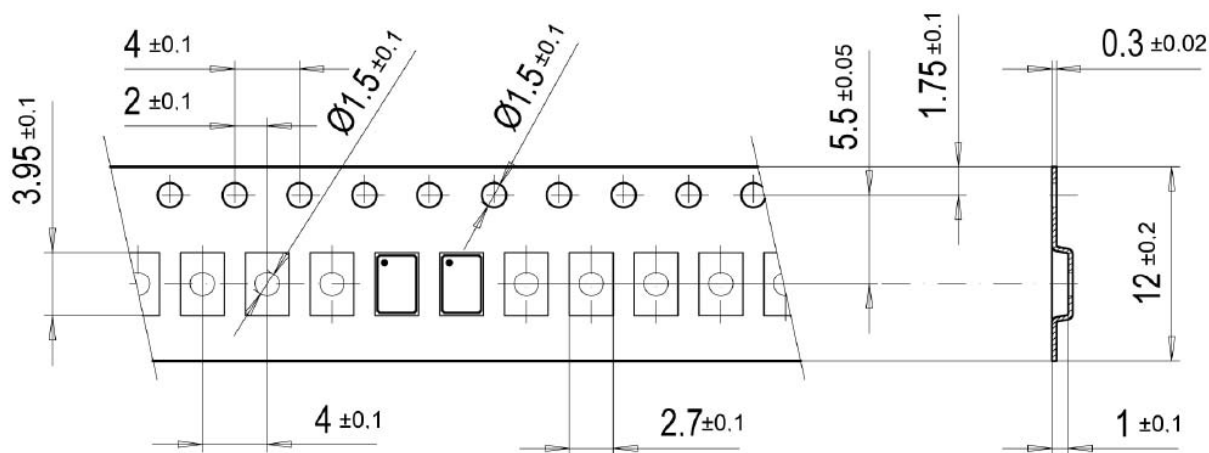

 User Direction of Feed

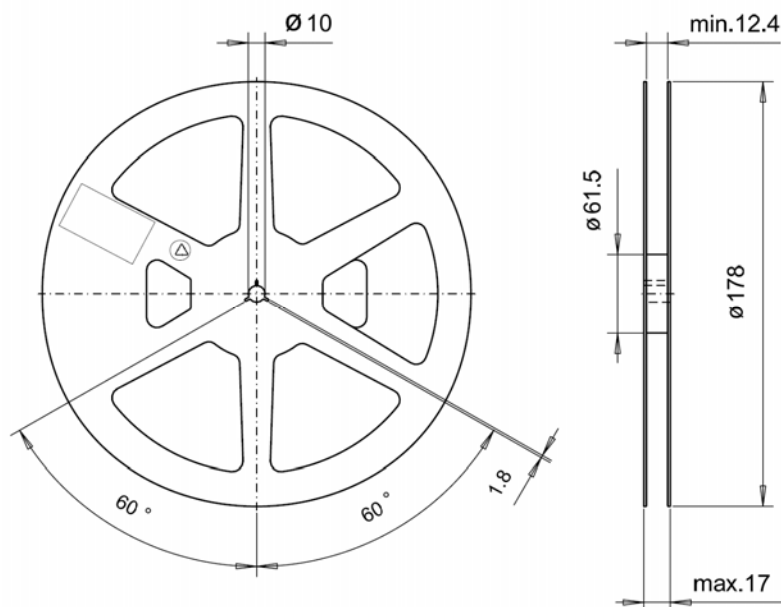

Dimension: mm

ATTENTION: Abracon LLC's products are COTS – Commercial-Off-The-Shelf products; suitable for Commercial, Industrial and, where designated, Automotive Applications. Abracon's products are not specifically designed for Military, Aviation, Aerospace, Life-dependent Medical applications or any application requiring high reliability where component failure could result in loss of life and/or property. For applications requiring high reliability and/or presenting an extreme operating environment, written consent and authorization from Abracon LLC is required. Please contact Abracon LLC for more information.



5101 Hidden Creek Ln Spicewood TX 78669
Phone: 512-371-6159 | Fax: 512-351-8858
For terms and conditions of sales, please visit:
www.abracon.com

REVISED: 11.28.2018

ABRACON IS
ISO9001-2015
CERTIFIED

Mouser Electronics

Authorized Distributor

Click to View Pricing, Inventory, Delivery & Lifecycle Information:

[ABRACON:](#)

[AB-RTCMC-32.768kHz-B5GA-S3-T](#)