

# General Specifications

## Electrical Capacity (Resistive Load)

<b>Switching Rating:</b>	100mA @ 5V DC
<b>Nonswitching Rating:</b>	100mA @ 50V DC

## Other Ratings

<b>Contact Resistance:</b>	80 milliohms maximum for circuit; 30 milliohms maximum for contact point
<b>Insulation Resistance:</b>	1,000 megohms minimum @ 250V DC
<b>Dielectric Strength:</b>	250V AC minimum for 1 minute minimum
<b>Mechanical Life:</b>	20,000 detent operations minimum
<b>Electrical Life:</b>	20,000 detent operations minimum
	Note: A detent operation is one actuator position operation or stepping. 20,000 detent operations = 1,250 cycles for hexadecimal devices or 2,000 cycles for decimal devices. A cycle is one 360° rotation.
<b>Nominal Operating Torque:</b>	.061 kgf/cm (.846 oz/in)
<b>Contact Timing:</b>	Nonshorting (break-before-make)

## Materials & Finishes

<b>Actuator:</b>	Glass fiber reinforced polyamide
<b>Housing:</b>	Glass fiber reinforced polyamide (UL94V-0)
<b>O-ring:</b>	Nitrile butadiene rubber
<b>Base:</b>	Glass fiber reinforced polyamide (UL94V-0)
<b>Movable Contact:</b>	Beryllium copper with gold plating
<b>Stationary Contacts:</b>	Brass with gold plating
<b>Terminals:</b>	Brass with gold plating

## Environmental Data

<b>Operating Temperature Range:</b>	-25°C through +85°C (-13°F through +185°F)
<b>Humidity:</b>	90 ~ 95% humidity for 100 hours @ 40°C (104°F)
<b>Vibration:</b>	10 ~ 55Hz with peak-to-peak amplitude of 1.5mm traversing the frequency range & returning in 1 minute; 3 right angled directions for 2 hours
<b>Shock:</b>	50G (490m/s <sup>2</sup> ) acceleration (tested in 6 right angled directions, with 5 shocks in each direction)

## Processing

<b>Soldering:</b>	Reflow Soldering: See Profile B in Supplement section. Note: During Reflow Soldering process, set the switch to the following position: ND3FR10, ND3FR16, ND3KR10, ND3KR16: 0 position; ND3FC10, ND3KC10: 7 position; ND3FC16, ND3KC16: F position. Manual Soldering: See Profile B in Supplement section.
<b>Cleaning:</b>	Automated cleaning. See Cleaning Specifications in Supplement section.

## Standards & Certifications

<b>Flammability Standards:</b>	UL94V-0 rated housing & base The ND3 Series rotaries have not been tested for UL recognition or CSA certification. These switches are designed for use in a low-voltage, low-current, logic-level circuit. When used as intended in a logic-level circuit, the results do not produce hazardous energy.
--------------------------------	--

# Distinctive Characteristics

Sealed construction prevents contact contamination and allows vapor phase and IR reflow soldering. Sealed design accomplished with seals between the actuator and housing and between housing and base.

Highly visible legends and choice of screwdriver or shaft actuation to provide trouble-free code setting.

Detent mechanism designed for crisp, positive action for accurate switch setting.

Bifurcated, spring loaded contacts give unmatched logic-level reliability.

Heat tolerant resin used for body meets UL flammability rating of 94V-0 and maintains switch reliability through vapor phase and infrared convection reflow soldering.

Gull-winged terminals ensure mechanical stability during soldering and simplified solder joint inspection.

.100" (2.54mm) terminal grid spacing between pin centers, plus 3-by-3 terminal arrangement for pad layout pattern equivalent to industry standard.

Epoxy sealed terminals lock out flux, solvents, and other contaminants.

Packaging in tape-reel or partitioned tray. Tape-reel packaging meets EIA-481-D Standard.

Coplanarity: all considered surfaces must lie between two parallel planes that are a maximum distance apart of .0059" (0.15mm). (Additional coplanarity details in Terms and Acronyms in the Supplement section.)

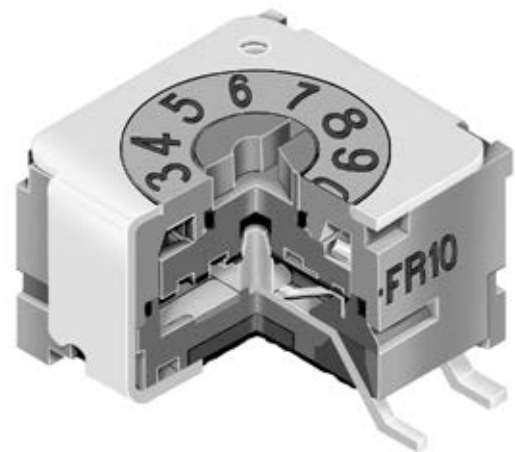

Actual Size

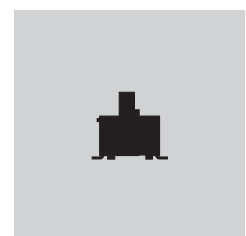

### TYPICAL SWITCH ORDERING EXAMPLE

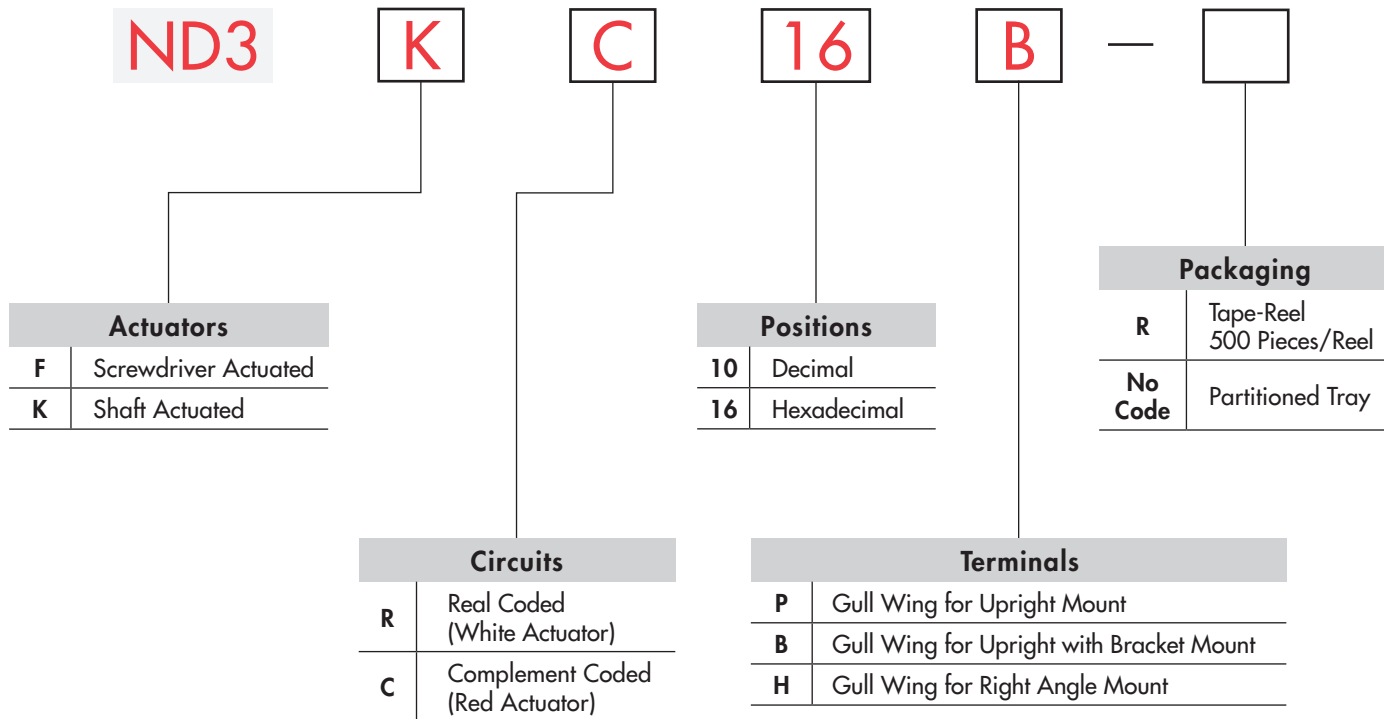

### DESCRIPTION FOR TYPICAL ORDERING EXAMPLE

**ND3KC16B**



### ACTUATION

**F** Screwdriver Actuated

Actuator colors:  
White for real coded  
Red for complement coded

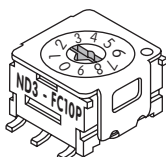

**K** Shaft Actuated

Actuator colors:  
White for real coded  
Red for complement coded

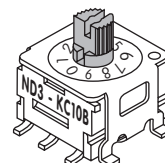

Actuators are fully rotational in either direction.

TRUTH TABLES (CIRCUITS & POSITIONS)

Terminal No. (Output)	Actuator Position ● = ON	10 Decimal									16 Hexadecimal																
		0	1	2	3	4	5	6	7	8	9	0	1	2	3	4	5	6	7	8	9	A	B	C	D	E	F
<b>R</b> Real Coded Model Numbers: ND3FR, ND3KR	1		●		●		●		●		●		●		●		●		●		●		●		●		●
	2			●	●			●	●					●	●					●	●					●	●
	4					●	●	●	●						●	●	●	●						●	●	●	●
	8									●	●								●	●	●	●					
<b>C</b> Complement Coded Model Numbers: ND3FC, ND3KC	1	●		●				●		●		●		●		●		●		●		●		●		●	
	2	●	●			●	●			●	●			●	●					●	●				●	●	
	4	●	●	●	●					●	●	●	●							●	●	●	●				
	8	●	●	●	●	●	●	●			●	●	●	●	●	●	●	●									

TYPICAL SWITCH DIMENSIONS

Screwdriver Actuated • Upright

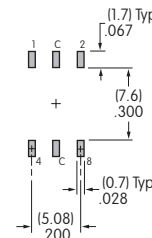
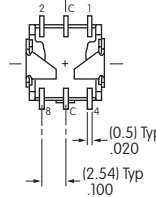
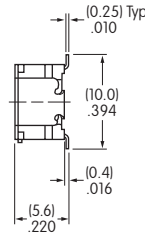
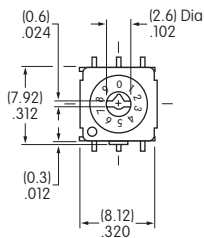

Terminal numbers are not on switch.

ND3FR10P

Shaft Actuated • Upright

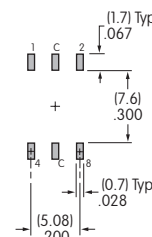
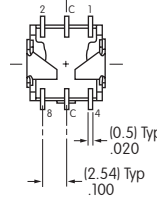
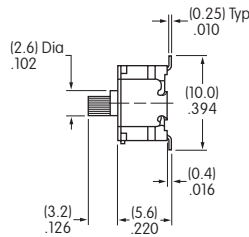
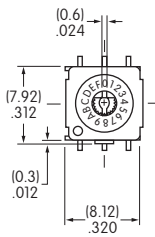

Terminal numbers are not on switch.

ND3KC16P

Screwdriver Actuated • Upright with Bracket

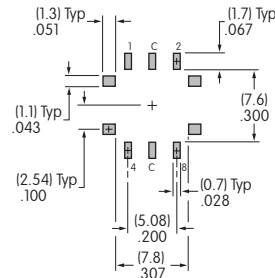
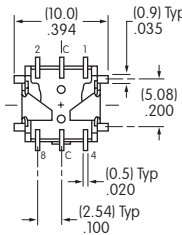
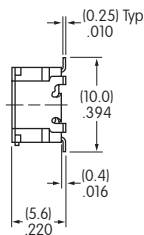
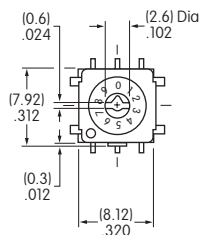

Terminal numbers are not on switch.

ND3FR10B

## TYPICAL SWITCH DIMENSIONS

### Shaft Actuated • Upright with Bracket

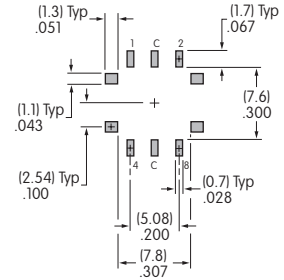
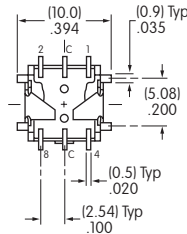
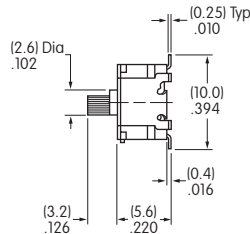
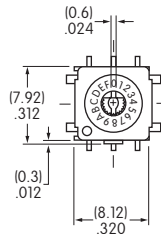

**ND3KC16B**

Terminal numbers are not on switch.

### Screwdriver Actuated • Right Angle

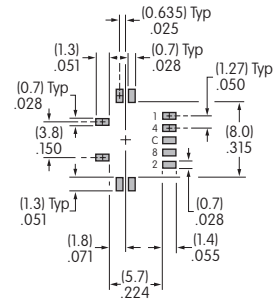
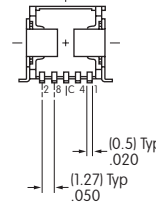
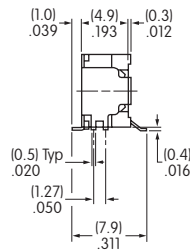
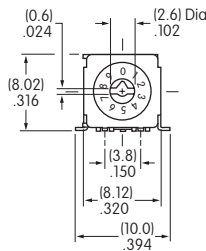

**ND3FC10H**

Terminal numbers are not on switch.

### Shaft Actuated • Right Angle

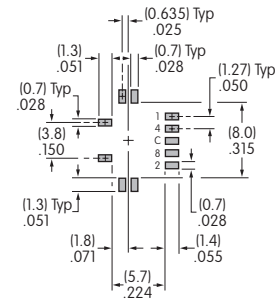
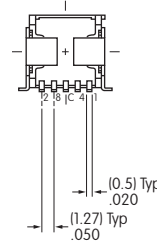
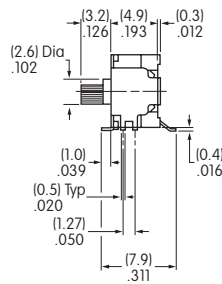
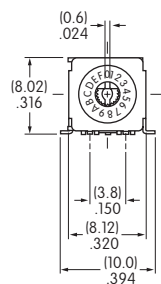

**ND3KR16H**

Terminal numbers are not on switch.

PACKAGING

**R** Tape-Reel Packaging for Upright & Right Angle

Switches must be ordered in 500-piece increments when tape-reel packaging is selected.

This packaging meets EIA-481-D Standard for "16mm and 24mm Embossed Carrier Taping of Surface Mount Components for Automatic Handling."

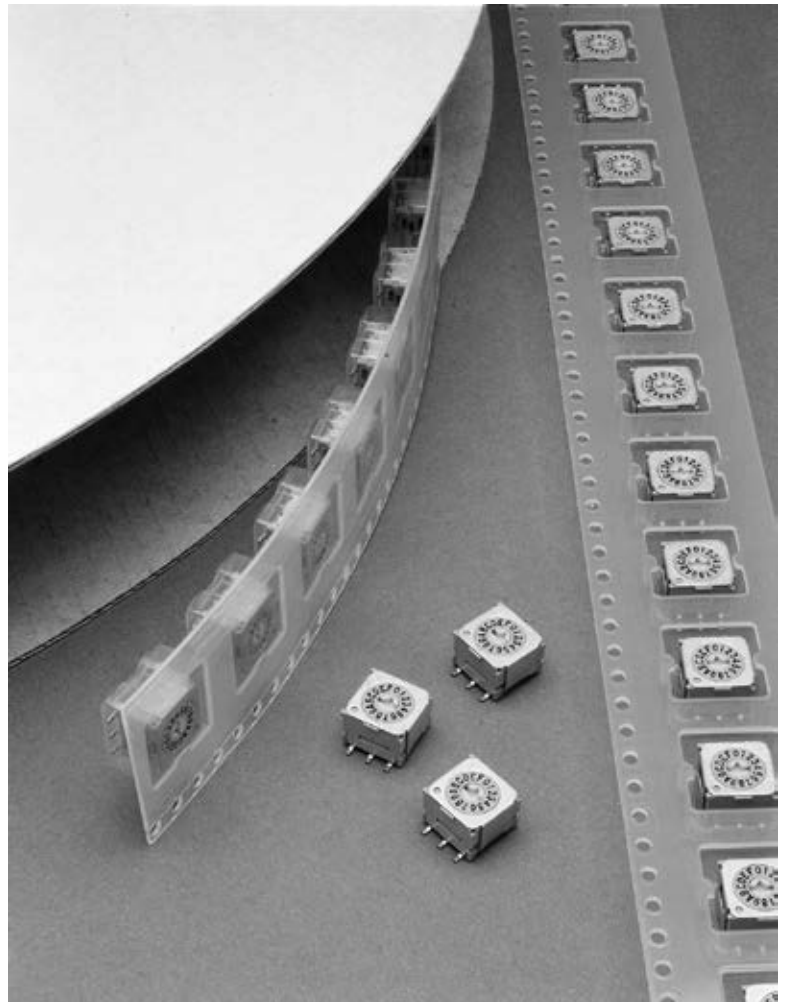

**No Code** Partitioned Tray for Upright & Right Angle Any Quantity

If the ND3 is ordered in less than 500-piece increments, the switches are packaged in a partitioned tray. No code is required.

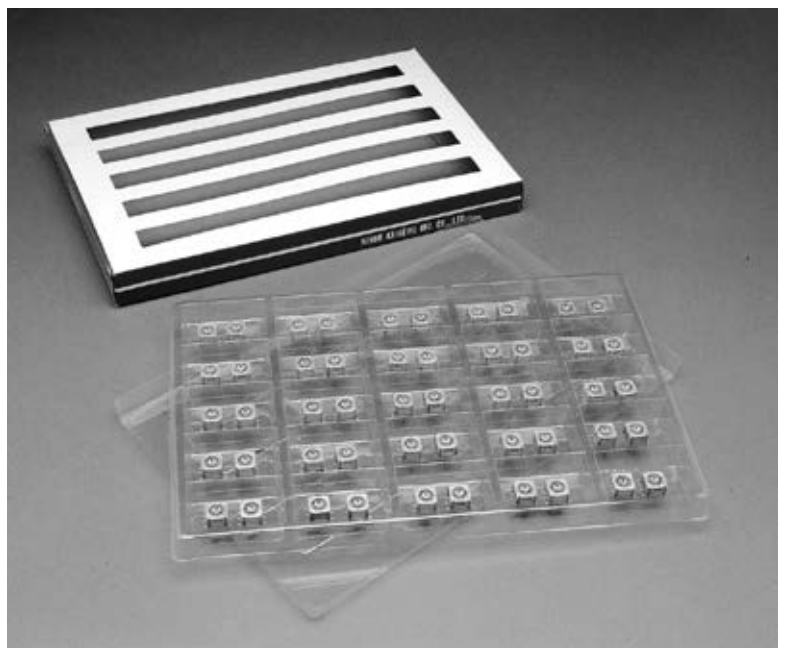

Toggles

Rockers

Pushbuttons

Illuminated PB

Programmable

Keylocks

**G** Rotaries

Slides

Tactiles

Tilt

Touch

Indicators

Accessories

Supplement

## PACKAGING (CONTINUED)

### For Upright & Upright with Bracket (Codes P & B with F Actuator)

Each tape-reel of 550 pockets contains 500 switches  
 Minimum Leader Length: 9.05" (230mm) Minimum Trailer Length: 6.30" (160mm)

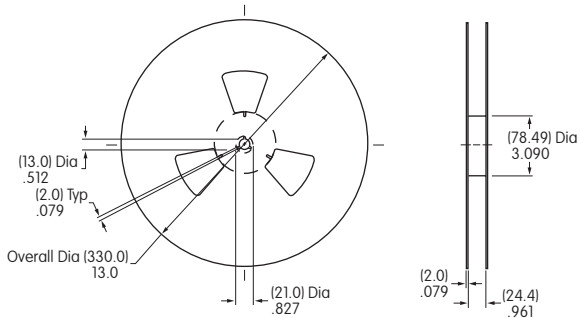

Reel Dimensions

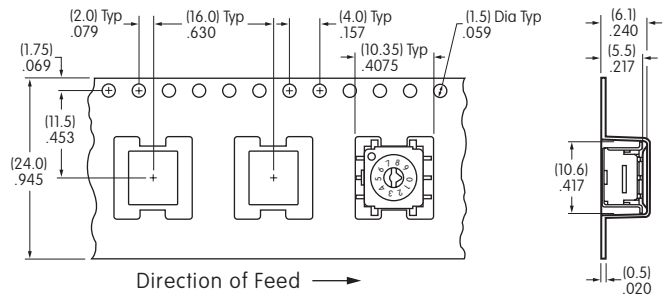

Tape Dimensions

### For Upright & Upright with Bracket (Codes P & B with K Actuator)

Each tape-reel of 530 pockets contains 500 switches  
 Minimum Leader Length: 9.05" (230mm) Minimum Trailer Length: 6.30" (160mm)

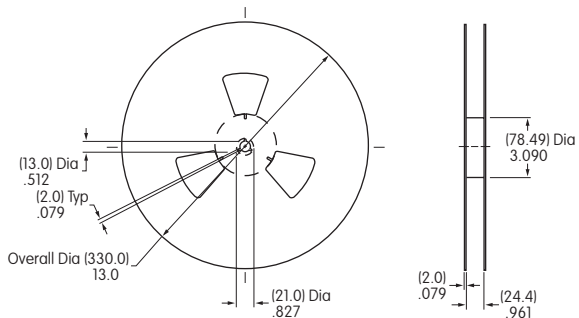

Reel Dimensions

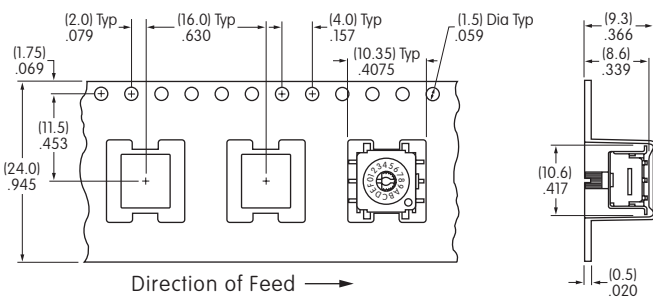

Tape Dimensions

### For Right Angle (Code H with F or K Actuator)

Each tape-reel of 550 pockets contains 500 switches  
 Minimum Leader Length: 9.05" (230mm) Minimum Trailer Length: 6.30" (160mm)

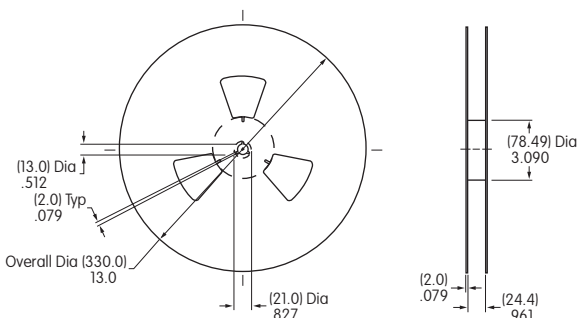

Reel Dimensions

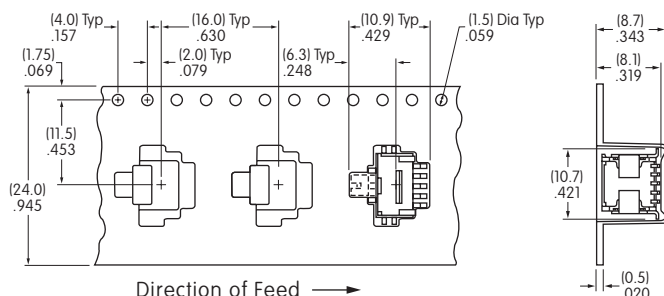

Tape Dimensions

# Mouser Electronics

Authorized Distributor

Click to View Pricing, Inventory, Delivery & Lifecycle Information:

## [NKK Switches:](#)

[ND3FR16P-R](#) [ND3KR16H-R](#) [ND3KR10B](#) [ND3KC10H](#) [ND3KR16H](#) [ND3KC16H](#) [ND3KC16H-R](#) [ND3FC16P-R](#)  
[ND3FC16P](#) [ND3FC10P-R](#) [ND3FR10H](#) [ND3FR16B-R](#) [ND3FC10H-R](#) [ND3KR10P](#) [ND3FR10P-R](#) [ND3FR16P](#)  
[ND3FC16H-R](#) [ND3FC10P](#) [ND3FR16B](#) [ND3FR16H-R](#) [ND3FC10H](#) [ND3FR10H-R](#) [ND3FR10P](#) [ND3FR16H](#)  
[ND3FC16H](#) [ND3FR10B](#) [ND3KR10H](#) [ND3FR10B-R](#) [ND3FC16B](#) [ND3KC16B-R](#) [ND3KR10H-R](#) [ND3KC10P](#)  
[ND3KR16P](#) [ND3KC16P](#) [ND3KC16B](#) [ND3KR16B](#) [ND3KC10B](#) [ND3FC10B](#) [ND3KR16P-R](#)