

General Specifications

Electrical Capacity (Resistive Load)

Power Level (silver):	6A @ 125V AC or 3A @ 250V AC; 4A @ 30V DC (On-On circuit) & 3A @ 30V DC (all other circuits)
Logic Level (gold):	0.4VA maximum @ 28V AC/DC maximum (Applicable Range 0.1mA ~ 0.1A @ 20mV ~ 28V)
Logic/Power Level: (gold over silver)	Combines silver & gold ratings

Note: Find additional explanation of dual rating & operating range in Supplement section.

Other Ratings

Contact Resistance:	10 milliohms maximum for silver; 20 milliohms maximum for gold
Insulation Resistance:	1,000 megohms minimum @ 500V DC
Dielectric Strength:	1,000V AC minimum between contacts for 1 minute minimum; 1,500V AC minimum between contacts & case for 1 minute minimum
Mechanical Life:	100,000 operations minimum
Electrical Life:	25,000 operations minimum for silver; 50,000 operations minimum for gold
Contact Timing:	Nonshorting (break-before-make)
Angle of Throw:	26°

Materials & Finishes

Toggle/Lever:	Brass with nickel plating
Support Bracket:	Brass with tin plating
Bushing/Housing:	Glass fiber reinforced polyamide (UL94V-0)
Sealing Ring:	Nitrile butadiene rubber
Base:	Glass fiber reinforced polyamide (UL94V-0)
Movable Contacts:	Silver alloy with silver plating (code W); copper or phosphor bronze with gold plating (code G); or silver alloy with gold plating (code A)
Stationary Contacts:	Silver alloy with silver plating (code W); copper or brass with gold plating (code G); or silver alloy with gold plating (code A)
Terminals:	Copper or brass with silver or gold plating

Environmental Data

Operating Temp Range:	-30°C through +85°C (-22°F through +185°F)
Humidity:	90 ~ 95% humidity for 96 hours @ 40°C (104°F)
Vibration:	10 ~ 55Hz with peak-to-peak amplitude of 1.5mm traversing the frequency range & returning in 1 minute; 3 right angled directions for 2 hours
Shock:	50G (490m/s ²) acceleration (tested in 6 right angled directions, with 5 shocks in each direction)

PCB Processing

Soldering:	Wave Soldering Recommended: See Profile B in Supplement section.
Cleaning:	Automated cleaning. See Cleaning specifications in Supplement section.

Standards & Certifications

Flammability Standards:	UL94V-0 rated bushing/housing & base
UL:	File No. E44145 - Recognized only when ordered with marking on switch. Add "/U" or "/CUL" before first dash in part number to order UL recognized switch. All models recognized at 6A @ 125V AC, 3A @ 250V AC, & 4A @ 30V DC or 0.4A @ 28V DC.
CSA:	File No. 023535_0_000 - Certified only when ordered with marking on switch. Add "/C" to end of part number to order CSA certified switch. All models certified at 6A @ 125V AC, 3A @ 250V AC, & 4A @ 30V DC.

Distinctive Characteristics

Antijamming actuator design protects against mechanism damage from downward force on the toggle.

Single unit construction of the bushing and top of the housing gives protection from cleaning fluids or other liquids.

O-ring surrounding actuator at top of bushing interior prevents liquids from reaching switch mechanism.

Ultrasonic welding of upper and lower housing seals out contaminants and allows automated soldering and cleaning.

Terminals are epoxy sealed to prevent entry of flux, solvents, and other contaminants.

Bracketed models have crimped legs to ensure secure PC mounting and prevent dislodging during automated soldering.

Logic level and power capabilities are available to suit varying applications.

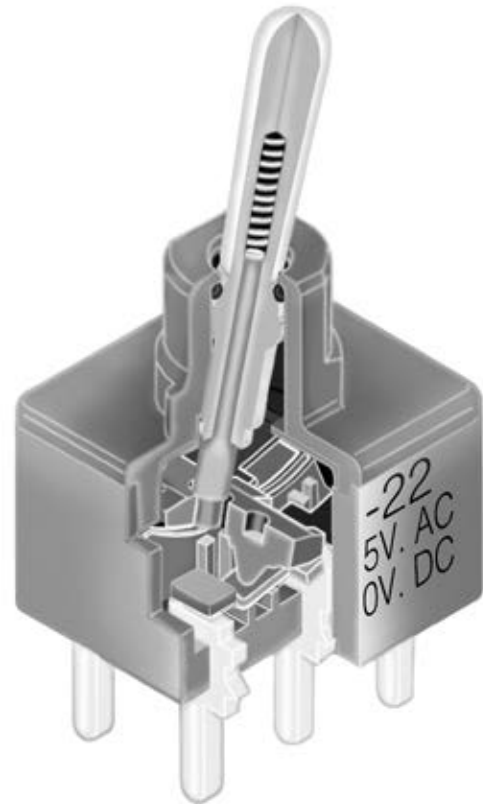

Actual Size

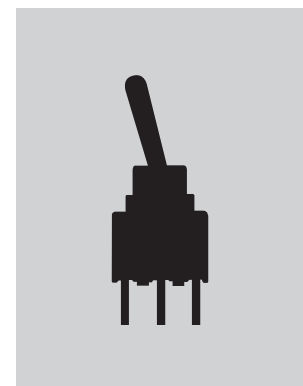

A
Toggles

Rockers

Pushbuttons

Illuminated PB

Programmable

Keylocks

Rotaries

Slides

Tactiles

Tilt

Touch

Indicators

Accessories

Supplement

TYPICAL SWITCH ORDERING EXAMPLE

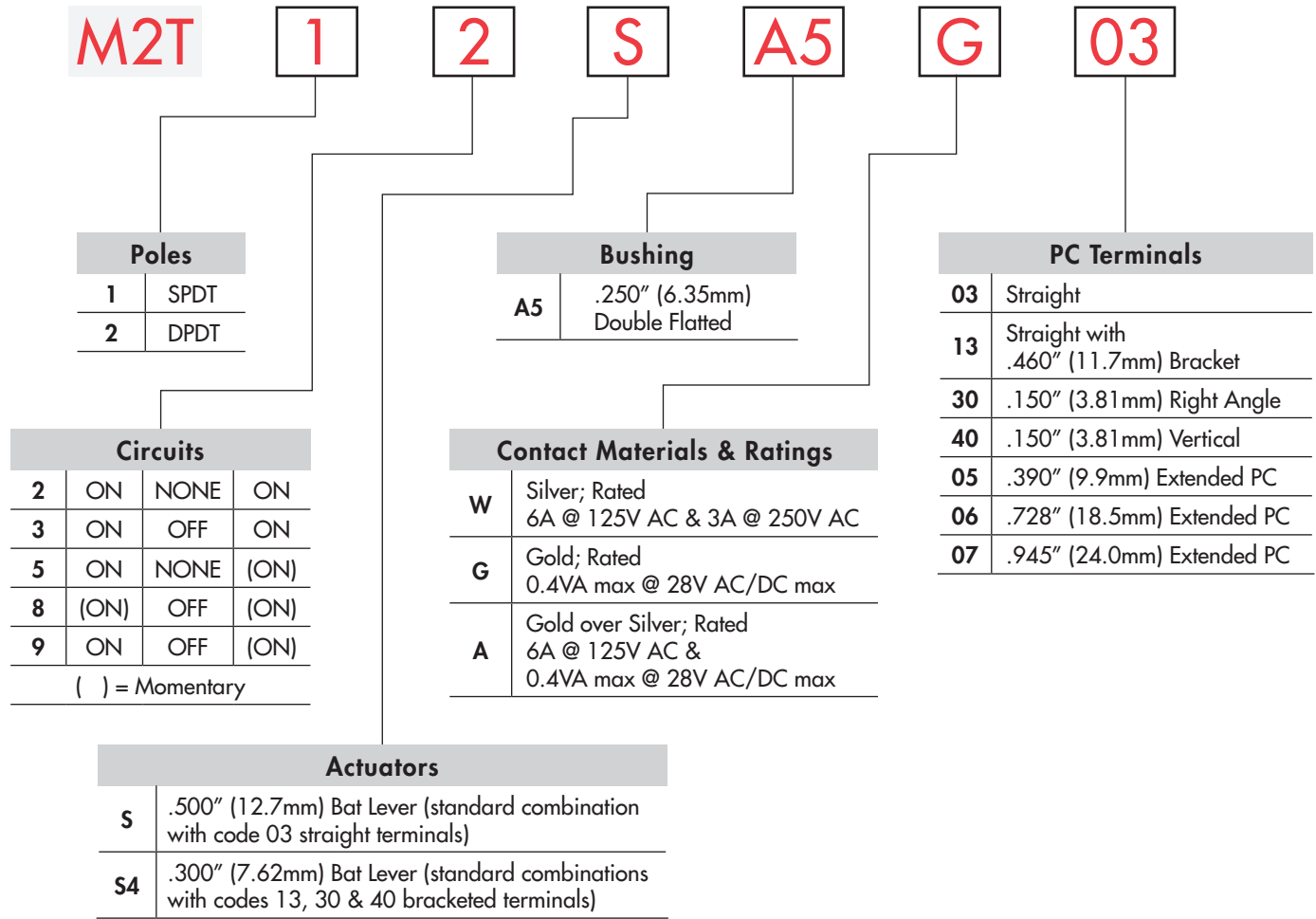

IMPORTANT:



Switches are supplied without UL, cULus & CSA marking unless specified. **UL, cULus & CSA recognized only when ordered with marking on the switch.** Specific models, ratings & ordering instructions are noted on the General Specifications page.

DESCRIPTION FOR TYPICAL ORDERING EXAMPLE

M2T12SA5G03

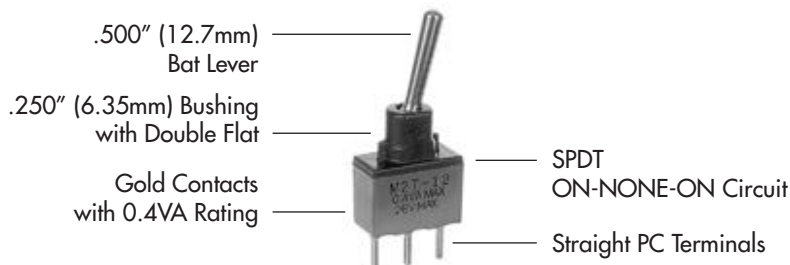

POLES & CIRCUITS

Pole	Model	Toggle Position () = Momentary			Connected Terminals			Throw & Schematics
		Down	Center	Up	Down	Center	Up	
								Note: Terminal numbers are not actually on the switch.
SP	M2T12 M2T13 M2T15 M2T18 M2T19	ON ON ON (ON) ON	NONE OFF NONE OFF OFF	ON ON (ON) (ON) (ON)	2-3	OPEN	2-1	SPDT
DP	M2T22 M2T23 M2T25 M2T28 M2T29	ON ON ON (ON) ON	NONE OFF NONE OFF OFF	ON ON (ON) (ON) (ON)	2-3 5-6	OPEN	2-1 5-4	DPDT

ACTUATORS

S .500" (12.7mm)
Bat Lever

Material:
Nickel over Brass

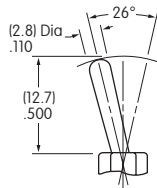

Standard Combinations: S Bat Lever with straight terminals (code 03) with silver or gold contacts.

S4 .300" (7.62mm)
Bat Lever

Material:
Nickel over Brass

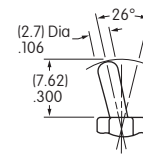

Standard Combinations: S4 Bat Lever with bracketed terminals (codes 13, 30, 40) with silver or gold contacts.

BUSHING

A5 .250" (6.35mm) Double Flatted

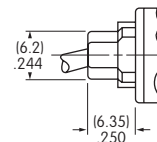
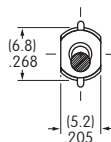

CONTACT MATERIALS & RATINGS

W Silver over Silver Power Level 6A @ 125V AC & 3A @ 250V AC

G Gold over Brass or Copper Logic Level 0.4VA maximum @ 28V AC/DC maximum
Complete explanation of operating range in Supplement section.

A Gold over Silver Power Level or Logic Level 6A @ 125V AC or 0.4VA maximum @ 28V AC/DC maximum

Note: This dual rated option is suitable when two or more identical switches are used in logic and in power circuits within the same application. See Supplement section for complete explanation of dual rating and operating range.

PC TERMINALS

03 Straight

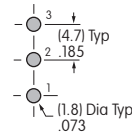
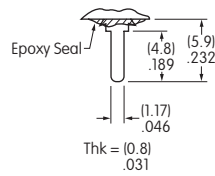

Single Pole

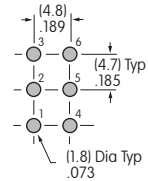

Double Pole

13 Straight with .460" (11.7mm) Bracket

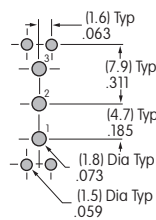
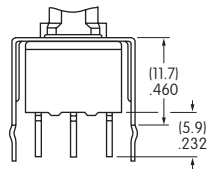

Single Pole

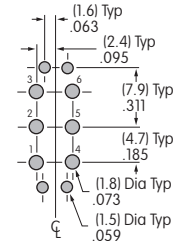

Double Pole

30 .150" (3.81mm) Right Angle

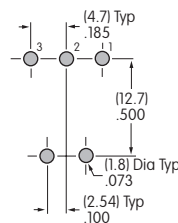
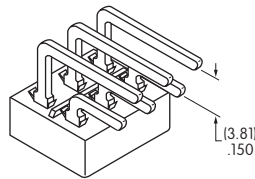

Single Pole

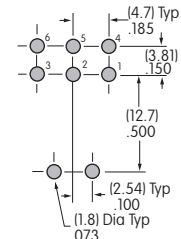

Double Pole

40 .150" (3.81mm) Vertical

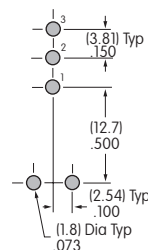
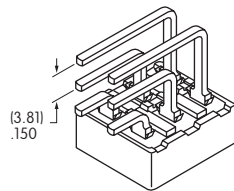

Single Pole

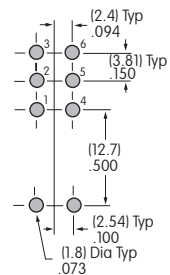

Double Pole

05 .390" (9.9mm) Extended PC

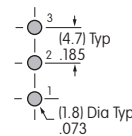
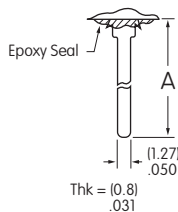

Single Pole

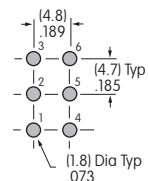

Double Pole

06 .728" (18.5mm) Extended PC

07 .945" (24.0mm) Extended PC

Dimension A = terminal lengths as shown beside the terminal codes at the left.

TYPICAL SWITCH DIMENSIONS

Single Pole

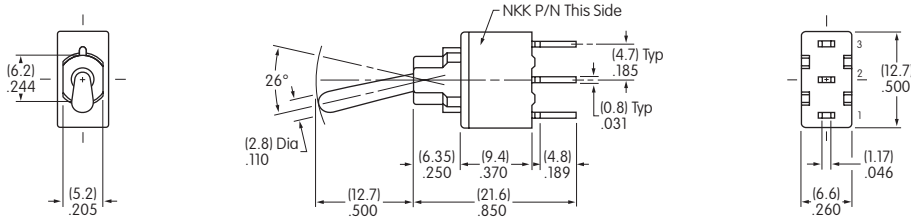

Actuator in Down Position

Straight PC



M2T12SA5G03

Double Pole

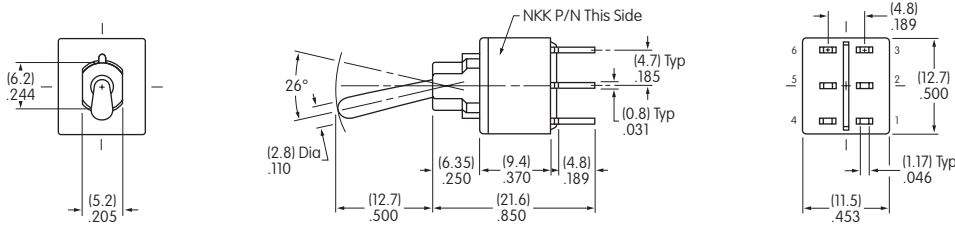

Actuator in Down Position

Straight PC



M2T22SA5G03

Single & Double Pole

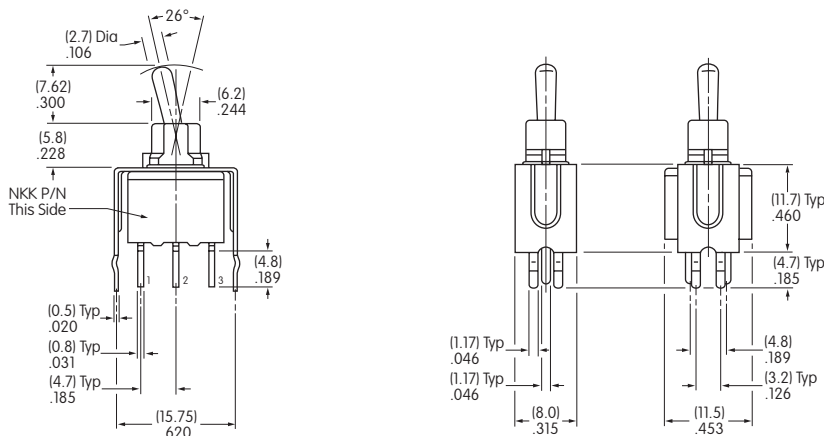

Actuator in Down Position

Straight PC • Bracket



M2T12S4A5G13

TYPICAL SWITCH DIMENSIONS

Right Angle PC

Single Pole

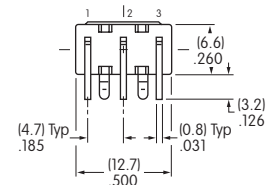
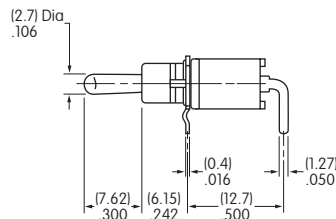
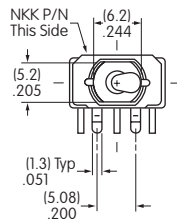

M2T12S4A5G30

Actuator in Down Position

Right Angle PC

Double Pole

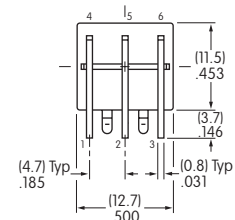
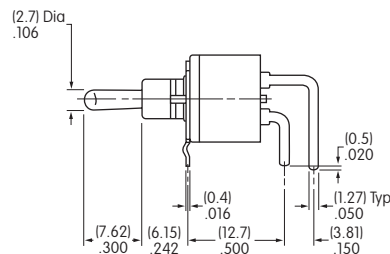
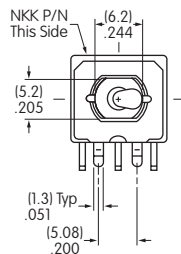

M2T22S4A5G30

Actuator in Down Position

Vertical PC

Single Pole

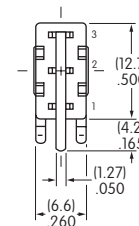
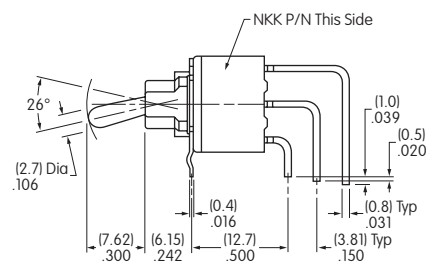
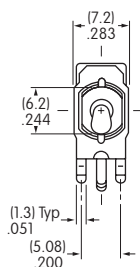

M2T12S4A5G40

Actuator in Down Position

Rockers

Pushbuttons

Illuminated PB

Programmable

Keylocks

Rotaries

Slides

Tactiles

Tilt

Touch

Indicators

Accessories

Supplement

TYPICAL SWITCH DIMENSIONS

Double Pole

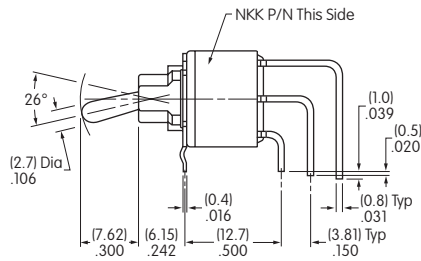
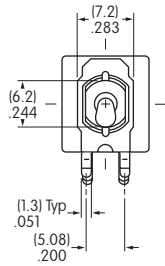

Actuator in Down Position

Vertical PC

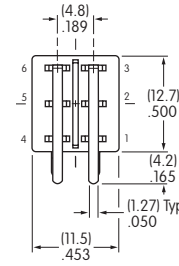

M2T22S4A5G40

HANDLING PRECAUTION

When an application employs M2T model with silver contacts, 5 to 6A @ 125V AC, and the switch will be actuated 100 or more times per day, note these instructions:

Peel off the film seal on the switch body situated over the part number after cleaning.

A
Toggles

Rockers

Pushbuttons

Illuminated PB

Programmable

Keylocks

Rotaries

Slides

Tactiles

Tilt

Touch

Indicators

Accessories

Supplement

Mouser Electronics

Authorized Distributor

Click to View Pricing, Inventory, Delivery & Lifecycle Information:

[NKK Switches:](#)

[M2T13S4A5G40](#) [M2T13S4A5G30](#) [M2T22SA5A03](#) [M2T18SA5G03](#) [M2T12SA5G03](#) [M2T13SA5G03](#) [M2T15SA5G03](#)
[M2T22SA5G03](#) [M2T12SA5W03](#) [M2T13SA5W03](#) [M2T22SA5W03](#) [M2T12SA5A03/UC](#) [M2T13SA5W03/U](#)
[M2T13SA5W03/UC](#) [M2T12SA5G03/U](#) [M2T18SA5A03/UC](#) [M2T25SA5G03](#) [M2T25SA5G30](#) [M2T23SA5W03](#)
[M2T18SA5W03](#) [M2T28SA5W03](#) [M2T19SA5W03](#) [M2T12S4A5W03](#) [M2T13S4A5W03](#) [M2T28SA5G03](#)
[M2T29SA5G03](#) [M2T12S4A5G03](#) [M2T15S4A5G03](#) [M2T12S4A5A03](#) [M2T22S4A5A03](#) [M2T13SA5W13](#)
[M2T28SA5A13](#) [M2T15SA5G30](#) [M2T15S4A5G30](#) [M2T22SA5A30](#) [M2T12S4A5A30](#) [M2T22S4A5A30](#) [M2T18SA5A03](#)
[M2T13SA5W05](#) [M2T13SA5W03/CUL](#) [M2T18SA5G30](#) [M2T15SA5W03/UC](#) [M2T25SA5W03](#) [M2T22SA5A13](#)
[M2T18S4A5G30](#) [M2T18SA5A13](#) [M2T12S4A5W13](#) [M2T22S4A5W30](#) [M2T28S4A5G13](#) [M2T18SA5G40](#)
[M2T22S4A5W13](#) [M2T23S4A5G40](#) [M2T15S4A5G13](#) [M2T12SA5W13](#) [M2T12S4A5G40](#) [M2T12SA5G30](#)
[M2T12S4A5G13](#) [M2T12SA5A13](#) [M2T29SA5W03](#) [M2T12S4A5W30](#) [M2T15SA5W03](#) [M2T12S4A5G40/UC](#)
[M2T29S4A5G30](#) [M2T12SA5G40](#) [M2T23S4A5G30](#) [M2T28SA5A13/UC](#) [M2T19S4A5G40](#) [M2T13SA5G13](#)
[M2T22S4A5G30](#) [M2T12S4A5W40](#) [M2T23S4A5W30](#) [M2T12S4A5G30](#) [M2T23SA5G30](#) [M2T22S4A5G40](#)
[M2T12SA5G13](#) [M2T13SA5G40](#) [M2T18S4A5G40](#) [M2T19SA5G03](#) [M2T22S4A5G13](#) [M2T25S4A5G13](#)
[M2T22SA5A13/CUL](#) [M2T29S4A5G40](#) [M2T19SA5G30](#) [M2T15SA5G13](#) [M2T13SA5W40](#) [M2T23S4A5W40](#)
[M2T15SA5A03](#) [M2T13S4A5A03](#) [M2T29S4A5W13](#) [M2T13S4A5W30](#) [M2T22SA5W13](#) [M2T18SA5W13](#)
[M2T12S4A5W40/U](#) [M2T18SA5A13/CUL](#) [M2T28SA5A13/CUL](#) [M2T12S4A5W40/CUL](#) [M2T22S4A5W13/CUL](#)
[M2T13SA5A13](#) [M2T12S4A5G40/CUL](#) [M2T18S4A5W13](#)