

# General Specifications

## Electrical Capacity (Resistive Load)

<b>Power Level (silver):</b>	3A @ 125V AC for silver contacts
<b>Logic Level (gold):</b>	0.4VA maximum @ 28V AC/DC maximum for gold contacts (Applicable Range 0.1mA ~ 0.1A @ 20mV ~ 28V) Note: Find additional explanation of operating range in Supplement section.

## Other Ratings

<b>Contact Resistance:</b>	10 milliohms maximum for silver; 20 milliohms maximum for gold
<b>Insulation Resistance:</b>	1,000 megohms minimum @ 500V DC
<b>Dielectric Strength:</b>	1,000V AC minimum between contacts for 1 minute minimum; 1,500V AC minimum between contacts and case for 1 minute minimum
<b>Mechanical Life:</b>	100,000 operations minimum
<b>Electrical Life:</b>	25,000 operations minimum for silver; 50,000 operations minimum for gold
<b>Nominal Operating Force:</b>	Single Pole: 1.75N for Momentary and 2.49N for Alternate Action Double Pole: 2.30N for Momentary and 3.05N for Alternate Action
<b>Travel:</b>	Momentary: Pretravel .047" (1.2mm); Overtravel .016" (0.4mm); Total Travel .063" (1.6mm) Alternate: Pretravel .071" (1.8mm); Overtravel .016" (0.4mm); Total Travel .087" (2.2mm)

## Materials & Finishes

<b>Plunger:</b>	Brass with nickel plating
<b>Bushing:</b>	Brass with nickel plating
<b>Frame:</b>	Stainless steel
<b>Case:</b>	Melamine phenolic resin (UL94V-0)
<b>Movable Contacts:</b>	Copper with silver or gold plating
<b>Stationary Contacts:</b>	Silver & copper with silver or gold plating
<b>Terminals:</b>	Copper with silver or gold plating

## Environmental Data

<b>Operating Temp Range:</b>	-10°C through +70°C (+14°F through +158°F)
<b>Humidity:</b>	90 ~ 95% humidity for 96 hours @ 40°C (104°F)
<b>Vibration:</b>	10 ~ 55Hz with peak-to-peak amplitude of 1.5mm traversing the frequency range & returning in 1 minute; 3 right angled directions for 2 hours
<b>Shock:</b>	50G (490m/s <sup>2</sup> ) acceleration (tested in 6 right angled directions, with 5 shocks in each direction)

## Installation

<b>Mounting Torque:</b>	1.47Nm (13.0 lb•in) for double nut; 0.68Nm (6.0 lb•in) for single nut
<b>Cap Installation Force:</b>	78.5N (17.65 lbf) maximum downward force on actuator
<b>Soldering Time &amp; Temp:</b>	Wave Solder (Straight PC): See Profile B in Supplement section. Manual Soldering: See Profile B in Supplement section.
<b>Cleaning:</b>	These devices are not process sealed. Hand clean locally using alcohol based solution.

## Standards & Certifications

<b>Flammability Standards:</b>	UL94V-0 case
<b>UL:</b>	<b>File No. E44145 - Recognized only when ordered with marking on switch.</b> Add "/U" or "/CUL" before first dash in part number to order UL recognized switch. All single and double pole models recognized at 3A @ 125V AC.
<b>CSA:</b>	<b>File No. 023535_0_000 - Certified only when ordered with marking on switch.</b> Add "/C" before first dash in part number to order CSA certified switch. Single pole solder lug and PC models certified at 3A @ 125V AC; double pole PC models certified at 3A @ 125V AC.

# Distinctive Characteristics

Power and logic level capabilities available to suit varying applications.

Bushing and snap-in mount versions available; snap-in models offer many style and color choices to enhance front panel appearance.

Light touch actuation.

High torque bushing prevents rotation and separation from metal frame during installation.

Stainless steel frame resists corrosion.

Case of heat resistant resin meets UL 94V-0 flammability rating.

Higher insulating barriers protect against crossover in double pole devices.

1,500V dielectric strength between contacts and case is accomplished by clinching the frame away from the terminals.

Epoxy sealed terminals prevent entry of solder flux and other contaminants.

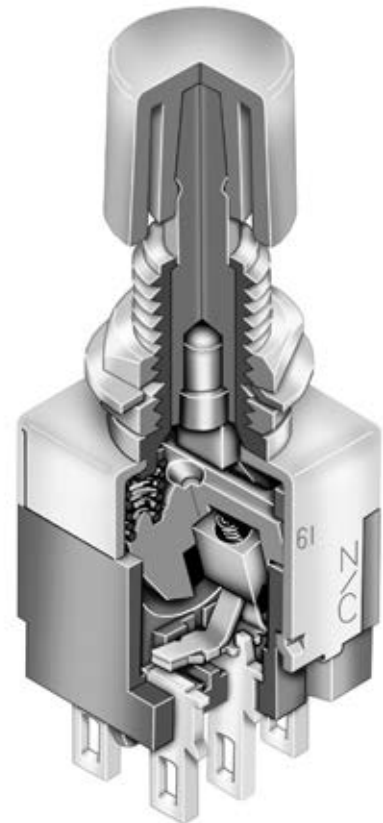

Actual Size

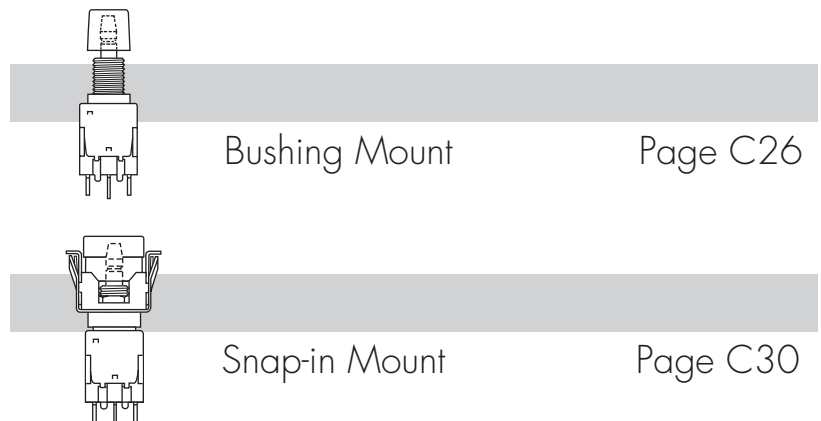
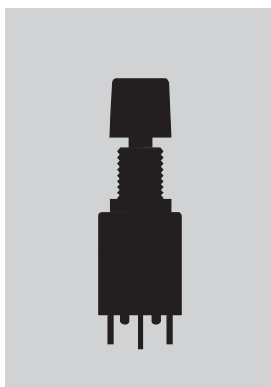

Supplement  
Accessories  
Indicators  
Touch  
Tilt  
Tactiles  
Slides  
Rotaries  
Keylocks  
Programmable  
Illuminated PB  
Pushbuttons  
Rockers  
Toggles

### TYPICAL SWITCH ORDERING EXAMPLE

**EB20**

**65**

**B**

**F**

#### Poles & Circuits

<b>11</b>	SPDT	ON	(ON)
<b>65</b>	SPDT	ON	ON
<b>61</b>	DPDT	ON	(ON)
<b>85</b>	DPDT	ON	ON

( ) = Momentary

#### Caps

<b>B</b>	.315" (8.0mm) Dia.
<b>C</b>	.394" (10.0mm) Dia.

#### Contacts, Ratings, & Terminals

<b>No Code</b>	Silver Contacts; Solder Lug Terminals 3A @ 125V AC
<b>G</b>	Gold Contacts; Solder Lug Terminals 0.4VA max @ 28V AC/DC max
<b>P</b>	Silver Contacts; Straight PC Terminals; 3A @ 125V AC
<b>PG</b>	Gold Contacts; Straight PC Terminals 0.4VA max @ 28V AC/DC max

#### Colors

<b>A</b>	Black
<b>B</b>	White
<b>C</b>	Red
<b>E</b>	Yellow
<b>F</b>	Green
<b>G</b>	Blue
<b>H</b>	Gray

#### IMPORTANT:





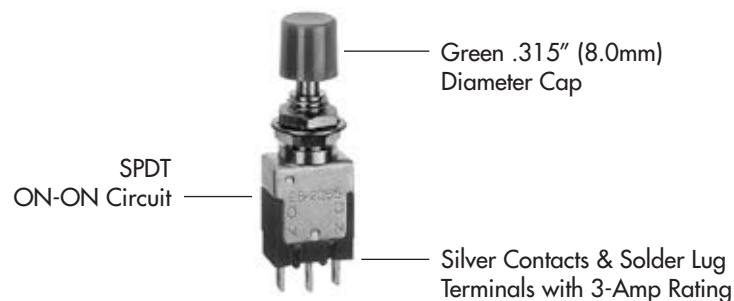

Switches are supplied without UL, cULus & CSA marking unless specified.  
**UL, cULus & CSA recognized only when ordered with marking on the switch.**  
 Specific models, ratings, & ordering instructions are noted on the General Specifications page.

#### DESCRIPTION FOR TYPICAL ORDERING EXAMPLE

**EB2065-BF**

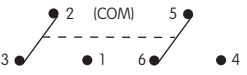

## POLES & CIRCUITS

Pole	Model	Plunger Position ( ) = Momentary		Connected Terminals		Throw & Switch Schematics
		Normal  Keyway	Down 	Normal  Keyway	Down 	
SP	EB2011 EB2065	ON ON	(ON) ON	2-3	2-1	SPDT 
DP	EB2061 EB2085	ON ON	(ON) ON	2-3 5-6	2-1 5-4	DPDT 

## CONTACT MATERIALS, RATINGS, & TERMINALS



**Solder Lug  
Silver Contacts**

**Power Level**

**3A @ 125V AC**



**Solder Lug  
Gold Contacts**

**Logic Level**

**0.4VA max @ 28V AC/DC max**

Complete explanation of operating range in Supplement section.

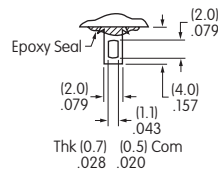

**Straight PC  
Silver Contacts**

**Power Level**

**3A @ 125V AC**



**Straight PC  
Gold Contacts**

**Logic Level**

**0.4VA max @ 28V AC/DC max**

Complete explanation of operating range in Supplement section.

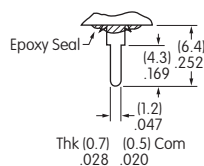

### PCB Footprints

Single Pole

Double Pole

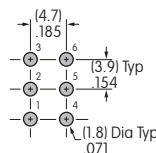
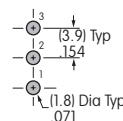

Toggles  
Rockers  
Pushbuttons  
Illuminated PB  
Programmable  
Keylocks  
Rotaries  
Slides  
Tactiles  
Tilt  
Touch  
Indicators  
Accessories  
Supplement

## CAPS & COLORS

**B** AT443  
.315" (8.0mm) Diameter Snap-on Cap

**C** AT442  
.394" (10.0mm) Diameter Snap-on Cap

Cap Colors Available:

- |                 |                |
|-----------------|----------------|
| <b>A</b> Black  | <b>F</b> Green |
| <b>B</b> White  | <b>G</b> Blue  |
| <b>C</b> Red    | <b>H</b> Gray  |
| <b>E</b> Yellow |                |

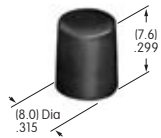

Cap Colors Available:

- |                 |                |
|-----------------|----------------|
| <b>A</b> Black  | <b>F</b> Green |
| <b>B</b> White  | <b>G</b> Blue  |
| <b>C</b> Red    | <b>H</b> Gray  |
| <b>E</b> Yellow |                |

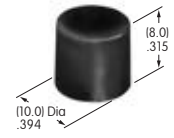

Cap Material: Polycarbonate Finish: Glossy

Cap Material: Polycarbonate Finish: Glossy

### Plunger Extension

Due to a difference in plunger lengths on the momentary and alternate action models, cap distance from top of bushing varies.

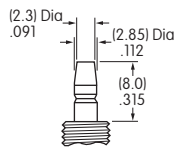

Momentary Plunger Length

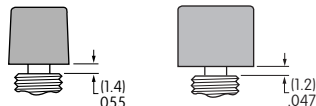

Momentary Cap Location

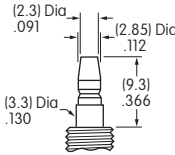

Alternate Plunger Length

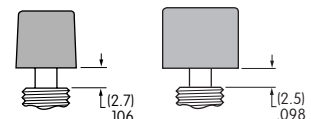

Alternate Cap Location

## TYPICAL SWITCH DIMENSIONS

### Solder Lug

### Single Pole



EB2011-BA

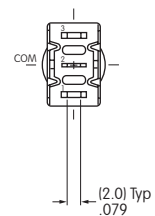
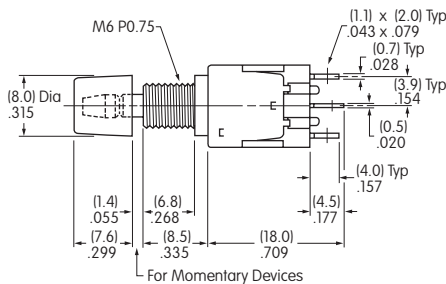
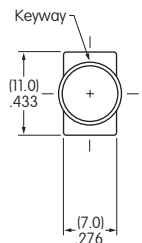

### Solder Lug

### Double Pole



EB2061-BA

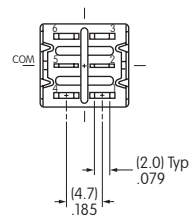
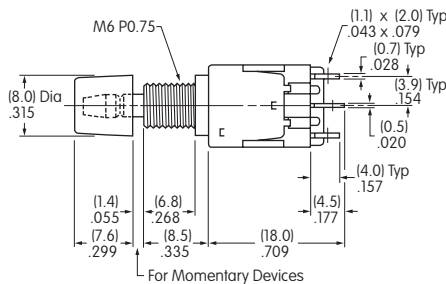
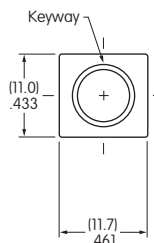

## HARDWARE

### Installation/Assembly

- 2 AT513M Metric Hexagon Nuts
- 1 AT509 Internal Tooth Lockwasher

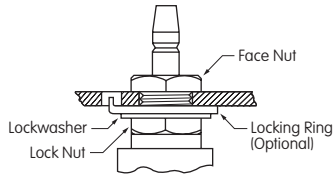

Optional Hardware:  
AT507M Metric Locking Ring

Note: Cap must be snapped on after the switch is mounted into the panel.

### Standard Hardware

#### AT513M Metric Hexagon Nut

Material:  
Brass with  
Nickel Plating

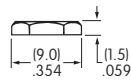
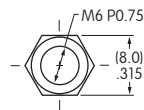

#### AT509 Lockwasher

Material:  
Steel with  
Zinc/Chromate

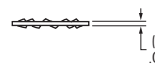
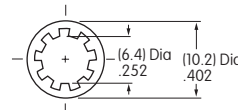

### Optional Hardware

#### AT507M Metric Locking Ring

Material:  
Steel with  
Zinc/Chromate

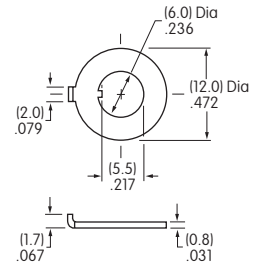

## PANEL CUTOUTS & THICKNESSES

### Metric Bushing

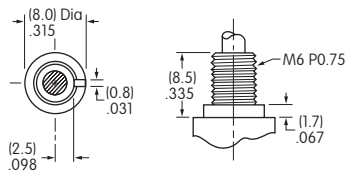

### With Standard Hardware

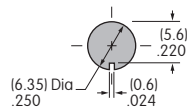

Maximum Effective  
Panel Thickness:  
.118" (3.0mm)

### With Standard Hardware & Optional Locking Ring

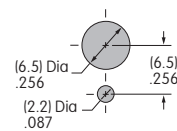

Maximum Effective  
Panel Thickness:  
.055" (1.4mm)

### Without Bottom Hex Nut

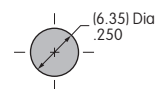

Maximum Effective  
Panel Thickness:  
.185" (4.7mm)

See Accessories & Hardware section for optional Conical Nuts:  
AT512M used with cap AT443 and AT512CM used with cap AT442.

EB20

11

B

J23

#### Poles & Circuits

11	SPDT	ON	(ON)
65	SPDT	ON	ON
61	DPDT	ON	(ON)
85	DPDT	ON	ON

( ) = Momentary

#### Contacts, Ratings, & Terminals

<b>No Code</b>	Silver Contacts; Solder Lug Terminals 3A @ 125V AC
<b>G</b>	Gold Contacts; Solder Lug Terminals 0.4VA max @ 28V AC/DC max
<b>P</b>	Silver Contacts; Straight PC Terminals; 3A @ 125V AC
<b>PG</b>	Gold Contacts; Straight PC Terminals 0.4VA max @ 28V AC/DC max

#### Cap Colors

<b>A</b>	Black
<b>B</b>	White
<b>C</b>	Red
<b>E</b>	Yellow
<b>F</b>	Green
<b>G</b>	Blue
<b>H</b>	Gray

#### Cap Extensions & Bezel Types

Low Rise		High Rise		Description
Momentary	Alternate	Momentary	Alternate	
J20	J30	J40	J50	Without Bezel
J21	J31	J41	J51	Bezel without LED
J22	J32	J42	J52	Bezel with 1 Round LED
J23	J33	J43	J53	Bezel with 2 Round LEDs
J24	J34	J44	J54	Bezel with 2 Rectangular LEDs

#### IMPORTANT:

Switches are supplied without UL, cULus & CSA marking unless specified.

**UL, cULus & CSA recognized only when ordered with marking on the switch.**

Specific models, ratings, & ordering instructions are noted on the General Specifications page.



#### DESCRIPTION FOR TYPICAL ORDERING EXAMPLE WITHOUT BEZEL

**EB2011-A-J40**

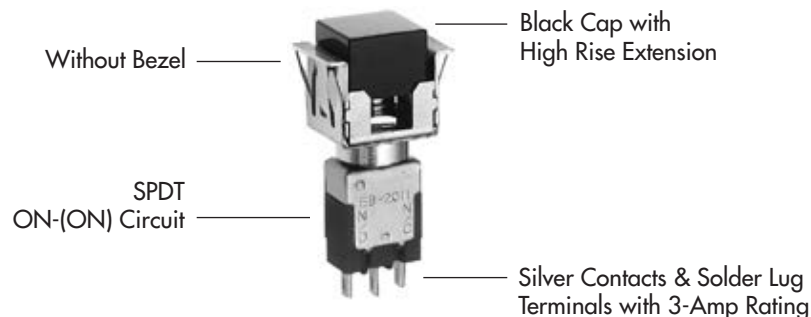

ORDERING EXAMPLES

<b>A</b>				<b>C F</b>			
<b>Bezel Colors</b>				<b>Led Colors</b>			
<b>Bezel without LEDs</b>							
<b>A</b>	Black	<b>F</b>	Green				
<b>B</b>	White	<b>G</b>	Blue				
<b>C</b>	Red	<b>H</b>	Gray				
<b>E</b>	Yellow						
<b>Bezel with 1 Round LED</b>				<b>1 LED</b>			
<b>A</b>	Black			<b>C</b>	Red		
				<b>F</b>	Green		
<b>Bezel with 2 Round or Rectangular LEDs</b>				<b>2 LEDs</b>			
				<b>Top LED</b>		<b>Bottom LED</b>	
<b>A</b>	Black			<b>C</b>	Red	<b>C</b>	Red
				<b>E</b>	Yellow	<b>E</b>	Yellow
				<b>F</b>	Green	<b>F</b>	Green

DESCRIPTION FOR TYPICAL ORDERING EXAMPLE WITH BEZEL

**EB2011-B-J23ACF**

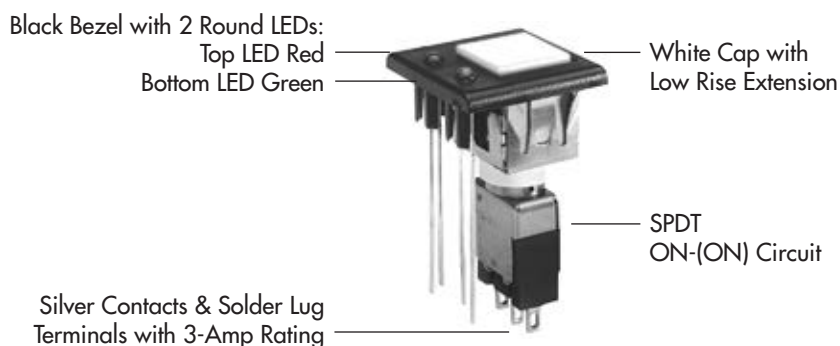



Toggles

Rockers

Pushbuttons

Illuminated PB

Programmable

Keylocks

Rotaries

Slides

Tactiles

Tilt

Touch

Indicators

Accessories

Supplement

## POLES & CIRCUITS

		Plunger Position ( ) = Momentary		Connected Terminals		Throw & Switch Schematics
Pole	Model	Normal 	Down 	Normal 	Down 	
SP	EB2011 EB2065	ON ON	(ON) ON	2-3	2-1	SPDT 
DP	EB2061 EB2085	ON ON	(ON) ON	2-3 5-6	2-1 5-4	DPDT 

Note: Terminal numbers are not actually on the switch.

## CONTACT MATERIALS, RATINGS, & TERMINALS



Solder Lug  
Silver Contacts

Power Level

3A @ 125V AC



Solder Lug  
Gold Contacts

Logic Level

0.4VA maximum @ 28V AC/DC maximum

Complete explanation of operating range in Supplement section.

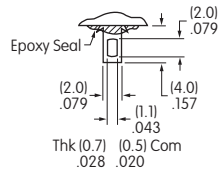

Straight PC  
Silver Contacts

Power Level

3A @ 125V AC



Straight PC  
Gold Contacts

Logic Level

0.4VA maximum @ 28V AC/DC maximum

Complete explanation of operating range in Supplement section.

### PCB Footprints

Single Pole

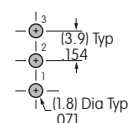

Double Pole

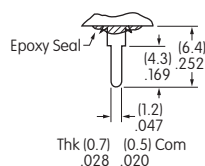
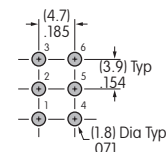

## CAP COLORS

Factory Assembled on the Switch:  
 Square snap-on cap AT465, snap-in moulder  
 AT529, and optional bezels which follow.

- |                |                |               |                 |
|----------------|----------------|---------------|-----------------|
| <b>A</b> Black | <b>B</b> White | <b>C</b> Red  | <b>E</b> Yellow |
| <b>F</b> Green | <b>G</b> Blue  | <b>H</b> Gray |                 |

## CAP EXTENSIONS & BEZEL TYPES

Cap Extension without Bezel

**J20**

Low Rise Momentary

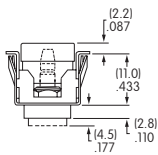

**J30**

Low Rise Alternate

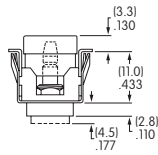

**J40**

High Rise Momentary

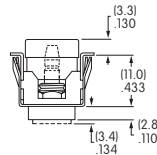

**J50**

High Rise Alternate

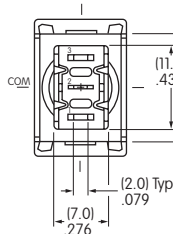
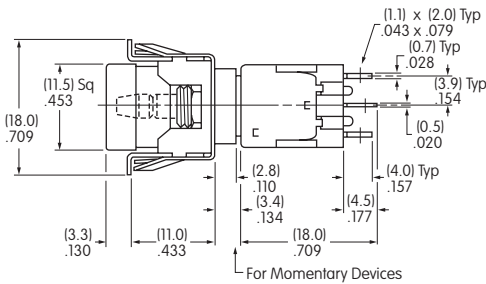
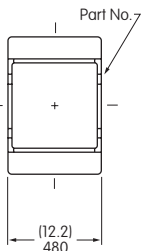
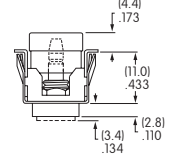

Maximum Panel Thickness  
 .039" ~ .157" (1.0mm ~ 4.0mm)  
 Cutout applies to SP & DP



High Rise

Single Pole

**EB2011-A-J40**

Cap Extension with Bezel

**J21**

Low Rise Momentary

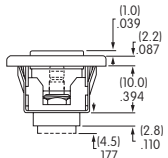

**J31**

Low Rise Alternate

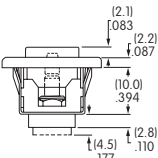

**J41**

High Rise Momentary

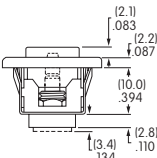

**J51**

High Rise Alternate

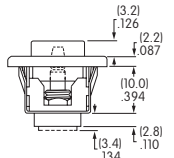

AT207 Bezel without LED

- |                 |                |                            |
|-----------------|----------------|----------------------------|
| <b>A</b> Black  | <b>F</b> Green | Material:<br>Polycarbonate |
| <b>B</b> White  | <b>G</b> Blue  |                            |
| <b>C</b> Red    | <b>H</b> Gray  | Finish:<br>Glossy          |
| <b>E</b> Yellow |                |                            |

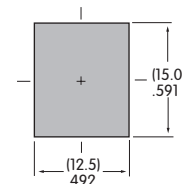
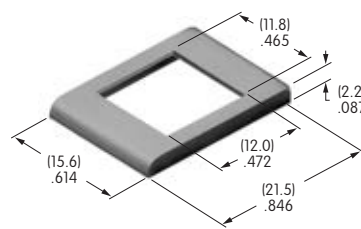

Maximum Panel Thickness  
 .039" ~ .126" (1.0mm ~ 3.2mm)  
 Cutout applies to SP & DP

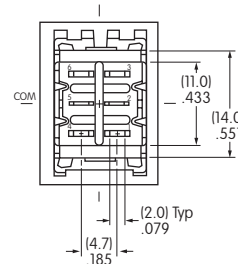
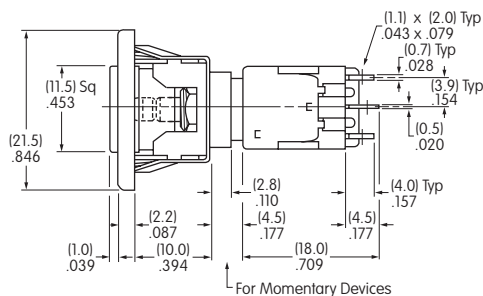
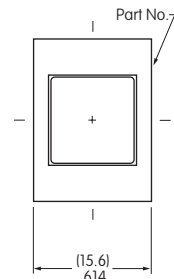

Low Rise

Double Pole

**EB2061-B-J21A**

## CAP EXTENSIONS & BEZEL TYPES

**Cap Extension with Bezel**

**J22**

Low Rise Momentary

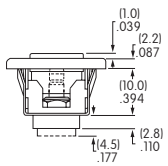

**J32**

Low Rise Alternate

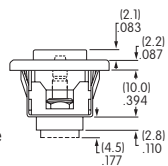

**J42**

High Rise Momentary

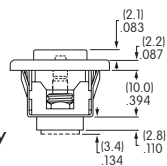

**J52**

High Rise Alternate

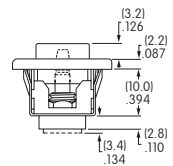

**AT208 Bezel with 1 Round LED (AT070 LED)**

**A** Black

Material: Polycarbonate  
Finish: Glossy

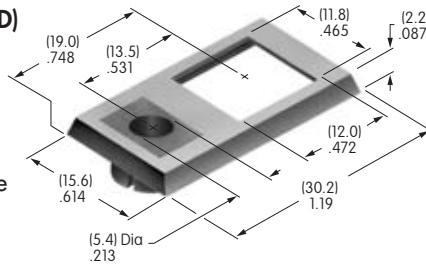

Maximum Panel Thickness  
.039" ~ .126"  
(1.0mm ~ 3.2mm)  
Cutout applies to SP & DP

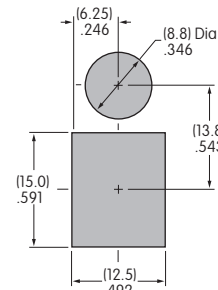

LED colors and specifications on next to last page of this EB section.

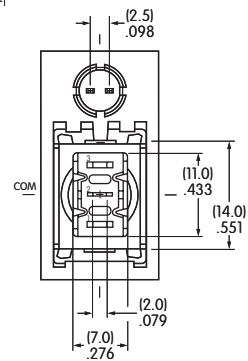
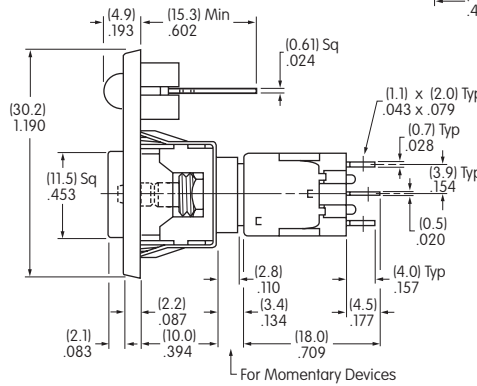
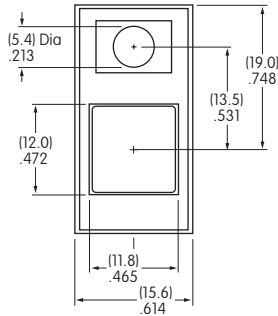

**EB2011-B-J42AC**

High Rise

Single Pole

**Cap Extension with Bezel**

**J23**

Low Rise Momentary

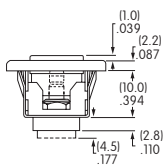

**J33**

Low Rise Alternate

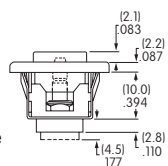

**J43**

High Rise Momentary

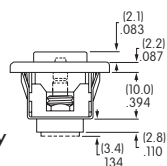

**J53**

High Rise Alternate

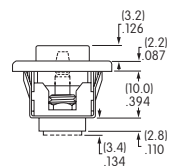

**AT212 Bezel with 2 Round LEDs (AT617 LEDs)**

**A** Black

Material: Polycarbonate  
Finish: Glossy

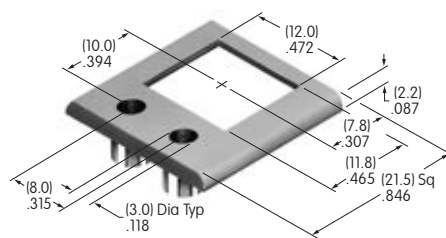

Maximum Panel Thickness  
.039" ~ .126" (1.0mm ~ 3.2mm)  
Cutout applies to SP & DP

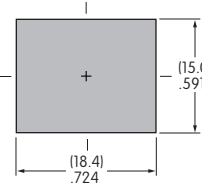

LED colors and specifications on next to last page of this EB section.

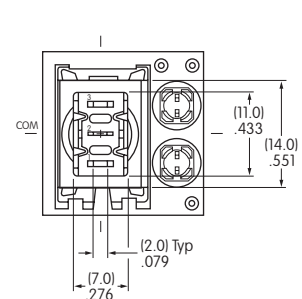
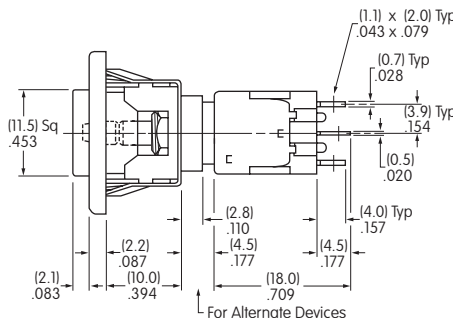
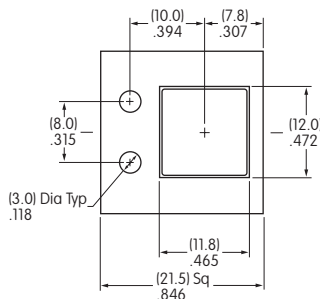

**EB2065-B-J33ACF**

Low Rise

Single Pole

## CAP EXTENSIONS & BEZEL TYPES

Cap Extension with Bezel

**J24**

Low Rise Momentary

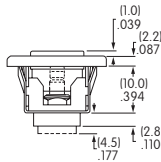

**J34**

Low Rise Alternate

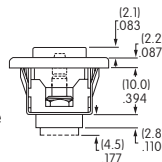

**J44**

High Rise Momentary

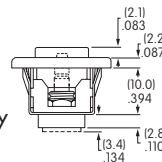

**J54**

High Rise Alternate

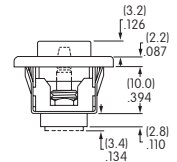

AT213 Bezel with 2 Rectangular LEDs (AT618 LEDs)

**A**

Black

Material: Polycarbonate  
Finish: Glossy

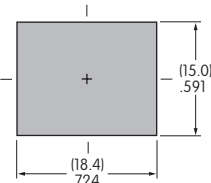
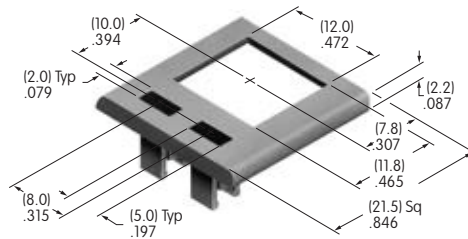

Maximum Panel Thickness  
.039" ~ .126" (1.0mm ~ 3.2mm)  
Cutout applies to SP & DP

LED colors and specifications on next page of this EB section.

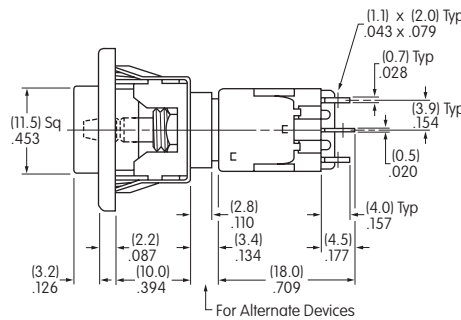
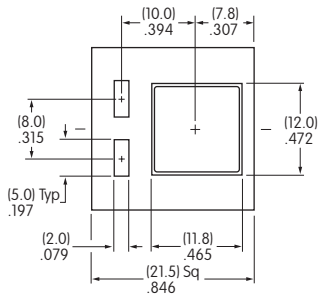

High Rise

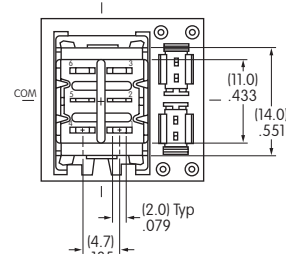

Double Pole



**EB2085-B-J54ACF**

### LED COLORS & SPECIFICATIONS

#### Bezel Orientation on Switch

**AT070 LED**  
For Bezel AT208  
with 1 LED

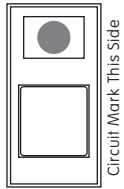

**AT617 LED**  
For Bezel AT212  
with 2 Round LEDs

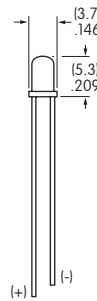
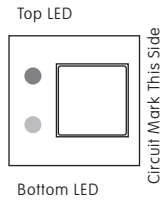

**AT618 LED**  
For Bezel AT213  
with 2 Rectangular LEDs

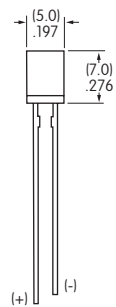
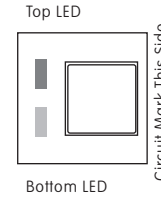

Note: Lead lengths may differ from manufacturing lot to lot. The longer lead is the anode (+).

		AT070		AT617			AT618		
		<b>C</b>	<b>F</b>	<b>C</b>	<b>E</b>	<b>F</b>	<b>C</b>	<b>E</b>	<b>F</b>
	Color	Red	Green	Red	Yellow	Green	Red	Yellow	Green
Maximum Forward Current	$I_{FM}$	25mA	30mA	30mA	30mA	30mA	25mA	30mA	25mA
Typical Forward Current	$I_F$	20mA	20mA	20mA	20mA	20mA	20mA	20mA	20mA
Forward Voltage	$V_F$	2.8V	2.1V	2.1V	2.1V	2.2V	2.25V	2.1V	2.2V
Maximum Reverse Voltage	$V_{RM}$	4V	5V	5V	5V	5V	5V	5V	5V
Current Reduction Rate Above 25°C	$\Delta I_F$	0.33 mA/°C	0.40 mA/°C	0.40 mA/°C	0.40 mA/°C	0.40 mA/°C	0.33 mA/°C	0.40 mA/°C	0.33 mA/°C
Ambient Temperature Range (when used with a bezel)		-10° ~ +70°C		-15° ~ +70°C			-25° ~ +50°C		

The electrical specifications shown are determined at a basic temperature of 25°C.  
LED circuit is independent of switch operation. LED is colored in OFF state.

If the source voltage is greater than the rated voltage of the LED, a ballast resistor must be connected in series with the lamp.  
The ballast resistor calculation and more lamp detail are shown in the Supplement section.

## LEGENDS

NKK Switches can provide custom legends for caps. Contact factory for more information.

### Suggested Printable Area for Cap

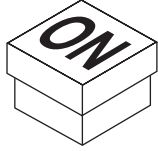

#### Recommended Print Method:

Screen Print or Pad Print

Epoxy based ink is recommended.

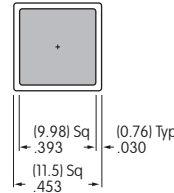

AT465

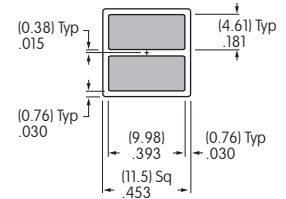

AT465

Shaded areas are printable areas.

Toggles

Rockers

**C** Pushbuttons

Illuminated PB

Programmable

Keylocks

Rotaries

Slides

Tactiles

Tilt

Touch

Indicators

Accessories

Supplement

# Mouser Electronics

Authorized Distributor

Click to View Pricing, Inventory, Delivery & Lifecycle Information:

## NKK Switches:

[EB2011-A-J40](#) [EB2011-B-J23ACF](#) [EB2061-A-J41A](#) [EB2011-B-J21B](#) [EB2011-H-J21H](#) [EB2011G-G-J21A](#) [EB2065P-A-J21A](#) [EB2061G-C-J21A](#) [EB2061P-B-J21A](#) [EB2085G-B-J51A](#) [EB2011P-A-J42AC](#) [EB2065-B-J22AF](#) [EB2011G-A-J23ACF](#) [EB2011G-B-J23AFE](#) [EB2011G-B-J24AFC](#) [EB2011P-A-J43ACF](#) [EB2065-F-J33ACF](#) [EB2065-A-J34ACF](#) [EB2085-B-J33AFF](#) [EB2085-B-J34AFF](#) [EB2085G-B-J33AEF](#) [EB2085G-B-J33AFE](#) [EB2085G-B-J33AFF](#) [EB2061G-B-J21A](#) [EB2065G-A-J32AF](#) [EB2085-A-J52AF](#) [EB2061P-H-J21H](#) [EB2011G-G-J41H](#) [EB2085G-C-J52AC](#) [EB2085G-F-J51F](#) [EB2085G-B-J51C](#) [EB2011G-B-J41B](#) [EB2085G-H-J51B](#) [EB2061-C-J22AF](#) [EB2061G-A-J21A](#) [EB2061-B-J22AF](#) [EB2061G-F-J41A](#) [EB2061P-A-J23ACF](#) [EB2061G-C-J41A](#) [EB2061-C-J23ACC](#) [EB2061-G-J23ACF](#) [EB2061-E-J21E](#) [EB2061-E-J23ACF](#) [EB2061-G-J44ACF](#) [EB2061P-A-J42AC](#) [EB2061-F-J42AF](#) [EB2061-B-J21B](#) [EB2061-A-J22AF](#) [EB2061-C-J42AC](#) [EB2061-B-J33ACF](#) [EB2061-A-J32AF](#) [EB2061G-A-J22AF](#) [EB2061-B-J21A](#) [EB2061P-B-J24ACC](#) [EB2061-G-J21G](#) [EB2011G-A-J24ACF](#) [EB2011P-B-J23ACF](#) [EB2011P-C-J40](#) [EB2011-G-J21A](#) [EB2011-F-J21F](#) [EB2011P-F-J40](#) [EB2011P-F-J22AC](#) [EB2011-C-J21H](#) [EB2011-B-J42AC](#) [EB2011-C-J34AFE](#) [EB2011G-G-J23ACF](#) [EB2011-F-J41A](#) [EB2011G-C-J21A](#) [EB2011-B-J41C](#) [EB2011-G-J21H](#) [EB2011-B-J41A](#) [EB2011G-B-J21A](#) [EB2011P-B-J21B](#) [EB2011-C-J24AFE](#) [EB2011-E-J21A](#) [EB2011P-H-J24AFE](#) [EB2011-C-J21C](#) [EB2011P-B-J20](#) [EB2011P-C-J41A](#) [EB2011-B-J24AFE](#) [EB2011-F-J24AFE](#) [EB2011-B-J24AFF](#) [EB2011-H-J31H](#) [EB2011-F-J22AC](#) [EB2011P-C-J22AC](#) [EB2011-F-J21A](#) [EB2011-F-J42AF](#) [EB2011G-F-J21A](#) [EB2011-C-J42AF](#) [EB2011-H-J24ACC](#) [EB2011-H-J24ACF](#) [EB2011-H-J40](#) [EB2011P-A-J51A](#) [EB2011G-A-J41A](#) [EB2011-B-J22AC](#) [EB2011-E-J42AF](#) [EB2011-B-J24ACF](#) [EB2011-F-J32AF](#) [EB2011P-B-J24ACF](#) [EB2011-G-J21G](#)