

LOW DROPOUT VOLTAGE REGULATOR

■ GENERAL DESCRIPTION

The NJM2830 is a 300mA output low dropout voltage regulator with ON/OFF control.

Advanced Bipolar technology achieves low noise, high ripple rejection and low quiescent current.

2.1V to 15.5V output voltage range, 1 μ F small decoupling capacitor, built-in noise bypass capacitor make the NJM2830 suitable for various applications.

■ PACKAGE OUTLINE

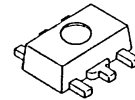

NJM2830U1

■ FEATURES

- Output voltage options available 2.1 ~ 15.5V (0.1V step)
- High Ripple Rejection 75dB typ. (f=1kHz Vo=3V Version)
- Output Noise Voltage Vno=50 μ Vrms typ. (Vo=3V Version)
- Output capacitor with 1.0 μ F ceramic capacitor (Vo \geq 5.6V)
- Output Current Io(max.)=300mA
- High Precision Output Vo \pm 1.0%
- Low Dropout Voltage 0.10V typ. (Io=100mA)
- ON/OFF Control (Active High)
- Internal Thermal Overload Protection
- Internal Over Current Protection
- Bipolar Technology
- Package Outline SOT-89-5

■ PIN CONFIGURATION

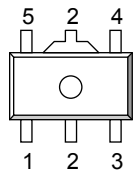

NJM2830U1

1. CONTROL
2. GND
3. N.C.
4. V_{OUT}
5. V_{IN}

■ BLOCK DIAGRAM

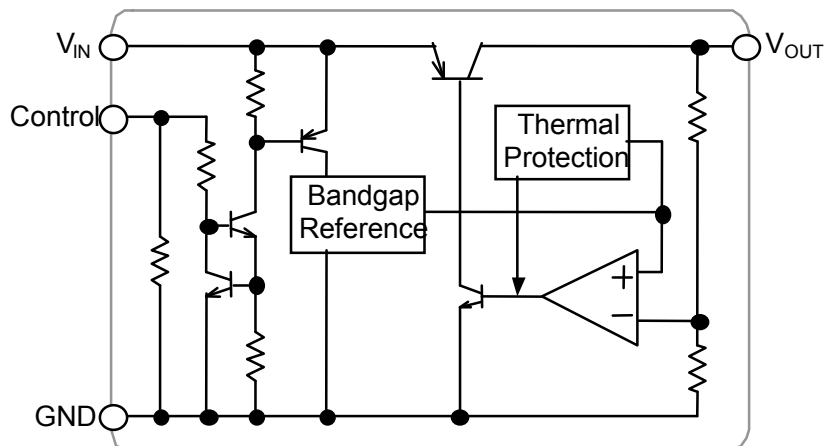

NJM2830

■ OUTPUT VOLTAGE RANK LIST

Device Name	Vout
NJM2830U1-21	2.1V
NJM2830U1-25	2.5V
NJM2830U1-03	3.0V
NJM2830U1-33	3.3V
NJM2830U1-05	5.0V
NJM2830U1-57	5.7V
NJM2830U1-58	5.8V
NJM2830U1-06	6.0V
NJM2830U1-08	8.0V
NJM2830U1-85	8.5V
NJM2830U1-86	8.6V
NJM2830U1-09	9.0V
NJM2830U1-12	12.0V
NJM2830U1-15	15.0V

The WHITE column shows applicable Voltage Rank(s)

■ ABSOLUTE MAXIMUM RATINGS (Ta=25°C)

PARAMETER	SYMBOL	RATINGS	UNIT
Input Voltage	V_{IN}	+20	V
Control Voltage	V_{CONT}	+20	V
Power Dissipation	P_D	625(*1) 960(*2)	mW
Operating Temperature	T_{opr}	-40~+85	°C
Storage Temperature	T_{stg}	-40~+150	°C

(*1): Mounted on glass epoxy board. (76.2 x 114.3 x 1.6mm:based on EIA/JDEC standard size, 2Layers, Cu area 100mm²)

(*2): Mounted on glass epoxy board. (76.2 x 114.3 x 1.6mm:based on EIA/JDEC standard, 4Layers)

(4Layers: Applying 74.2 x 74.2mm inner Cu area and a thermal via hole to a board based on JEDEC standard JESD51-5)

■ INPUT VOLTAGE RANGE

$V_{IN}=+2.3V\sim 18V$ (In case of $V_o < 2.2V$)

■ ELECTRICAL CHARACTERISTICS

($V_{IN}=V_o+1V$, $C_{IN}=0.1\mu F$, $C_o=1.0\mu F$ (4.9V< $V_o\leq 5.5V$: $C_o=2.2\mu F$, 2.9V< $V_o\leq 4.9V$: $C_o=4.7\mu F$, $V_o\leq 2.9V$: $C_o=10\mu F$), $T_a=25^\circ C$)

PARAMETER	SYMBOL	TEST CONDITION	MIN.	TYP.	MAX.	UNIT	
Output Voltage	V_o	$I_o=30mA$	-1.0%	-	+1.0%	V	
Quiescent Current	I_Q	$I_o=0mA$, except I_{cont}	$V_o\leq 5V$ Version	-	130	180	μA
			5V< $V_o\leq 10V$ Version	-	145	195	μA
			10V< $V_o\leq 15V$ Version	-	160	210	μA
Quiescent Current at Control OFF	$I_{Q(OFF)}$	$V_{CONT}=0V$	-	-	100	nA	
Output Current	I_o	$V_o=0.3V$	300	400	-	mA	
Line Regulation	$\Delta V_o/\Delta V_{IN}$	$V_{IN}=V_o+1V \sim V_o+6V$ ($V_o\leq 12V$ Version) $V_{IN}=V_o+1V \sim 18V$ ($V_o>12V$ Version), $I_o=30mA$	-	-	0.10	%/V	
Load Regulation	$\Delta V_o/\Delta I_o$	$I_o=0 \sim 300mA$	-	-	0.009	%/mA	
Dropout Voltage(*1)	ΔV_{I-O}	$I_o=100mA$	-	0.10	0.18	V	
Ripple Rejection	RR	$e_{in}=200mV_{rms}$, $f=1kHz$, $I_o=10mA$, $V_o=3V$ Version	-	75	-	dB	
Average Temperature Coefficient of Output Voltage	$\Delta V_o/\Delta T_a$	$T_a=0 \sim 85^\circ C$, $I_o=10mA$	-	± 50	-	ppm/°C	
Output Noise Voltage	V_{NO}	$f=10Hz \sim 80kHz$, $I_o=10mA$ $V_o=3V$ Version	-	50	-	μV_{rms}	
Control Current	I_{CONT}	$V_{CONT}=1.6V$	-	3	12	μA	
Control Voltage for ON-state	$V_{CONT(ON)}$		1.6	-	-	V	
Control Voltage for OFF-state	$V_{CONT(OFF)}$		-	-	0.6	V	

(*3): The above specification is a common specification for all output voltages.

Therefore, it may be different from the individual specification for a specific output voltage.

NJM2830

TEST CIRCUIT

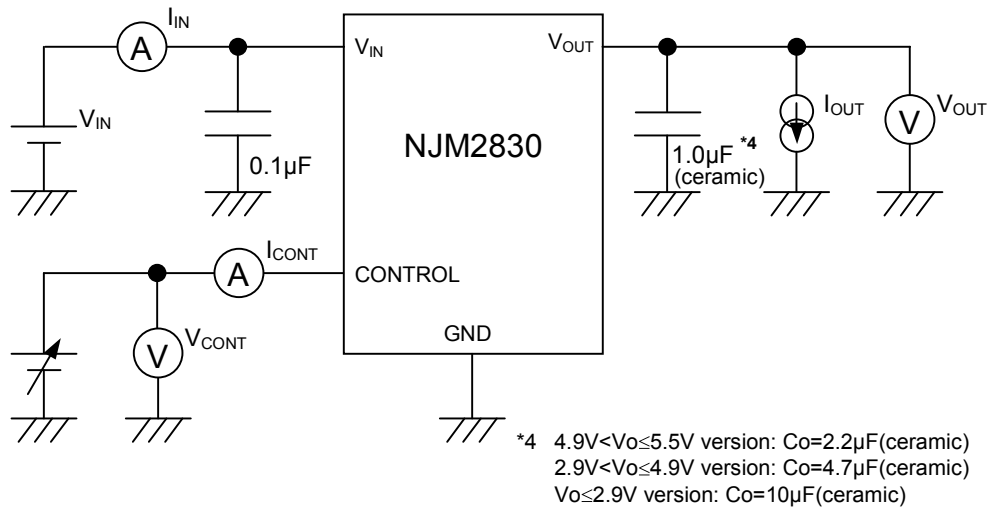

TYPICAL APPLICATIONS

① In the case where ON/OFF Control is not required:

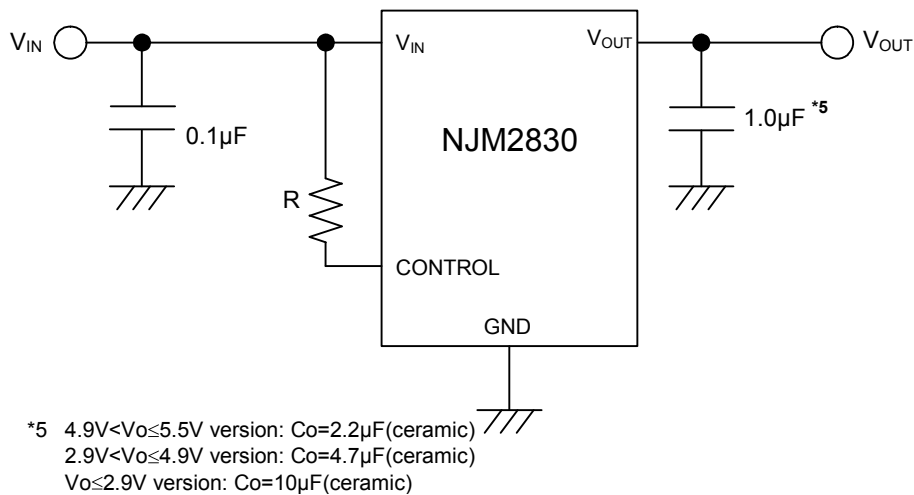

Connect control pin to V_{IN} pin

② In use of ON/OFF CONTROL:

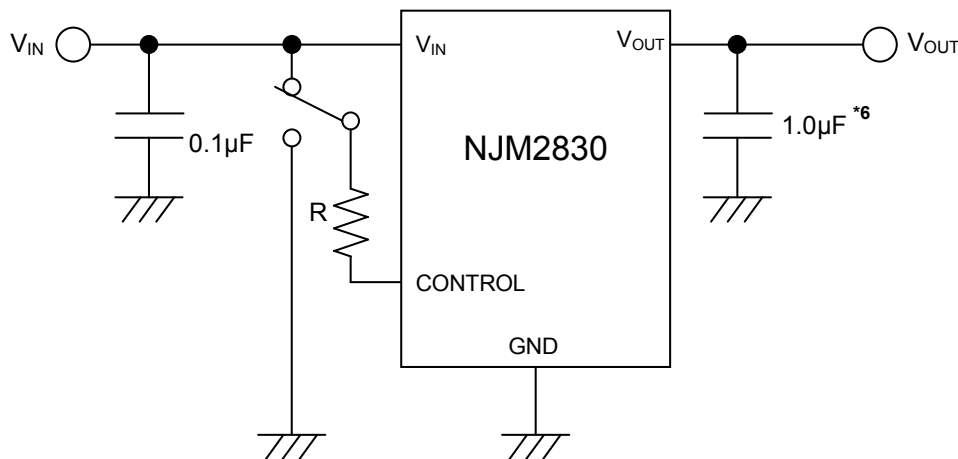

*6 4.9V<V_O≤5.5V version: C_O=2.2µF(ceramic)
 2.9V<V_O≤4.9V version: C_O=4.7µF(ceramic)
 V_O≤2.9V version: C_O=10µF(ceramic)

State of control pin:

- “H” → output is enabled.
- “L” or “open” → output is disabled.

*In the case of using a resistance "R" between V_{IN} and control.

If this resistor is inserted, it can reduce the control current when the control voltage is high. The applied voltage to control terminal should set to consider voltage drop through the resistor "R" and the minimum control voltage for ON-state. The V_{CONT(ON)} and I_{CONT} have temperature dependence as shown in the "Control Current vs. Temperature" and "Control Voltage vs. Temperature" characteristics. Therefore, the resistance "R" should be selected to consider the temperature characteristics.

*Input Capacitor C_{IN}

Input Capacitor C_{IN} is required to prevent oscillation and reduce power supply ripple for applications when high power supply impedance or a long power supply line. Therefore, use the recommended C_{IN} value (refer to conditions of ELECTRIC CHARACTERISTIC) or larger and should connect between GND and V_{IN} as shortest path as possible to avoid the problem.

*Output Capacitor C_O

Output capacitor (C_O) will be required for a phase compensation of the internal error amplifier.

The capacitance and the equivalent series resistance (ESR) influence to stable operation of the regulator. Use of a smaller C_O may cause excess output noise or oscillation of the regulator due to lack of the phase compensation. On the other hand, Use of a larger C_O reduces output noise and ripple output, and also improves output transient response when rapid load change. Therefore, use the recommended C_O value (refer to conditions of ELECTRIC CHARACTERISTIC) or larger and should connect between GND and V_{OUT} as shortest path as possible for stable operation.

The recommended capacitance depends on the output voltage rank. Especially, low voltage regulator requires larger C_O value. In addition, you should consider varied characteristics of capacitor (a frequency characteristic, a temperature characteristic, a DC bias characteristic and so on) and unevenness peculiar to a capacitor supplier enough.

When selecting C_O, recommend that have withstand voltage margin against output voltage and superior temperature characteristic though this product is designed stability works with wide range ESR of capacitor including low ESR products.

NJM2830

■ TYPICAL CHARACTERISTICS

● DC CHARACTERISTICS (3V Version)

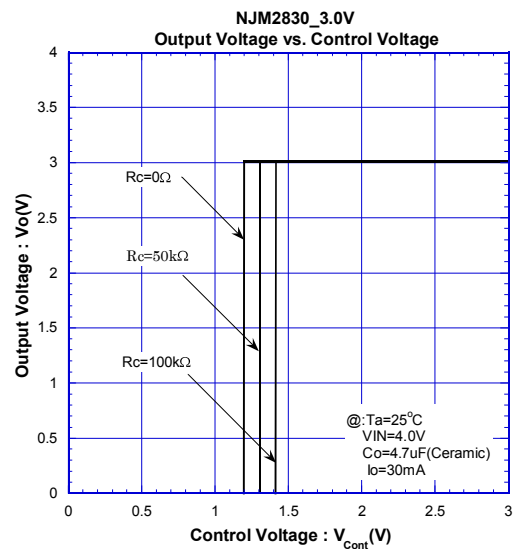
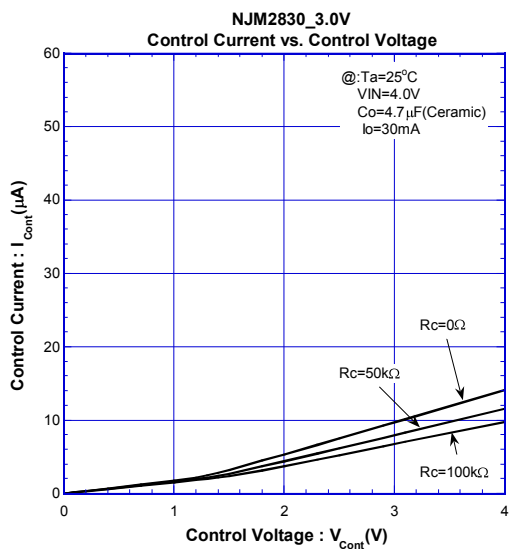
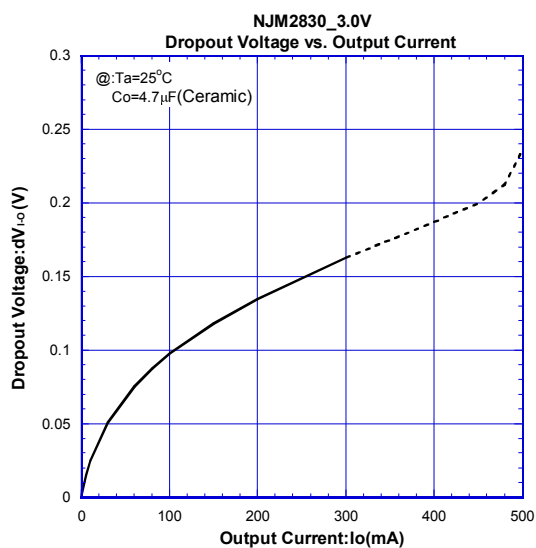
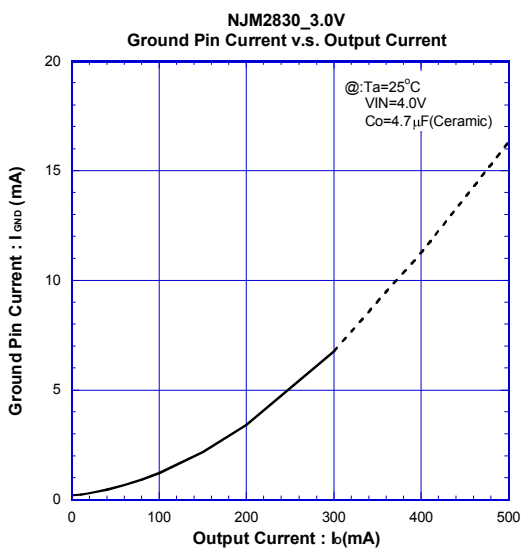
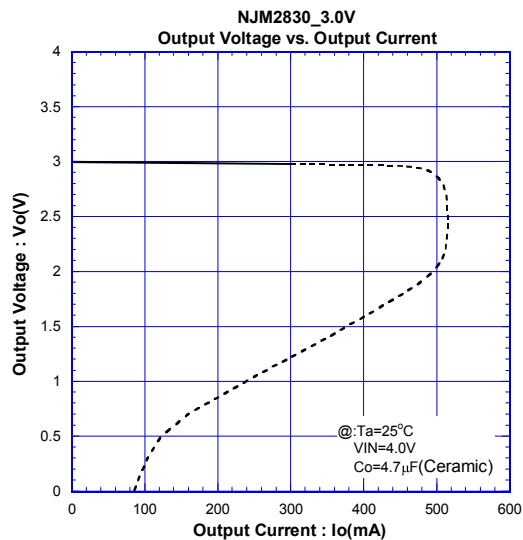
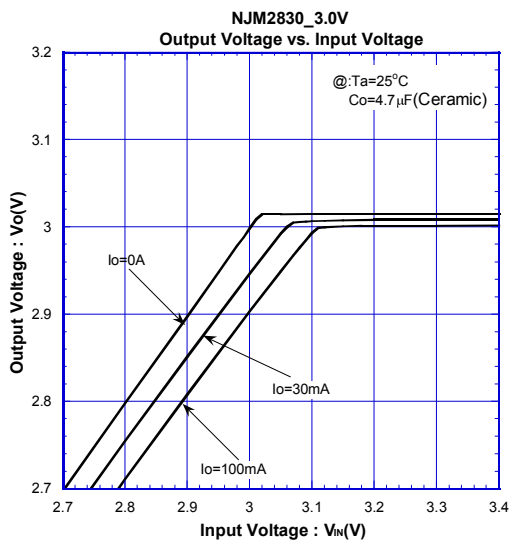

TYPICAL CHARACTERISTICS

DC CHARACTERISTICS (3V Version)

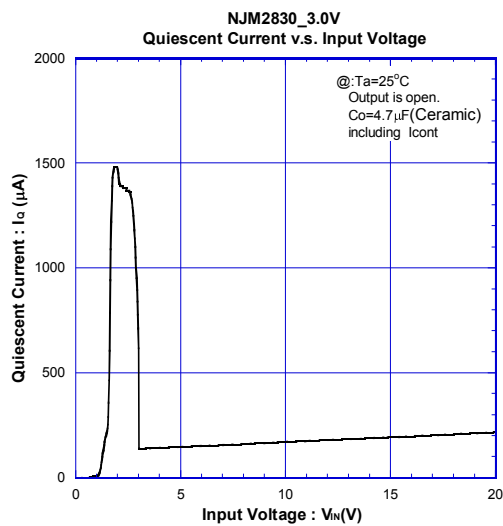
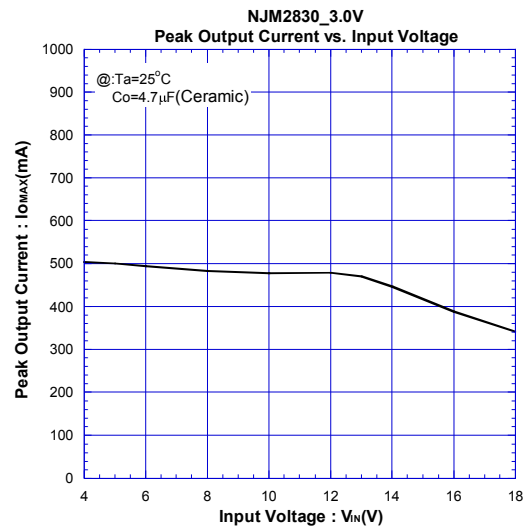
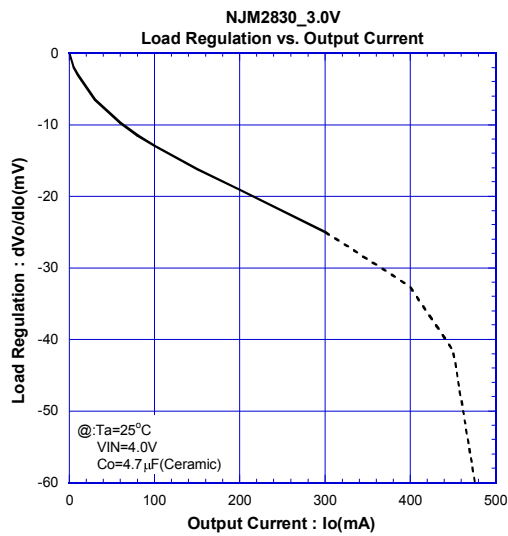

NJM2830

TYPICAL CHARACTERISTICS

AC CHARACTERISTICS (3V Version)

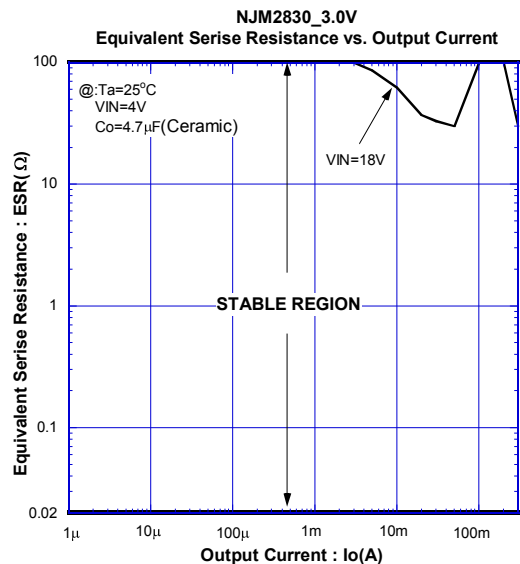
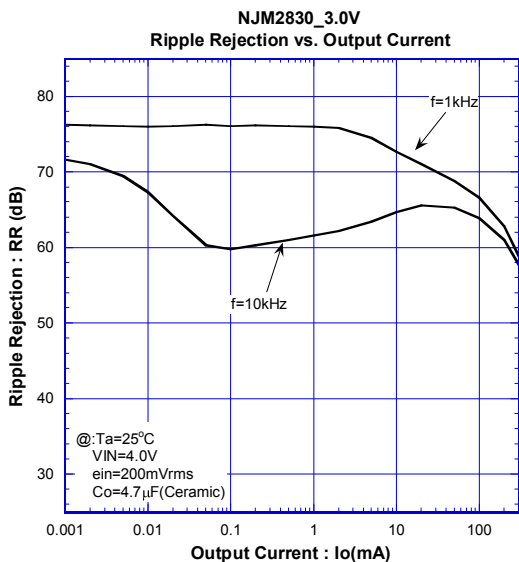
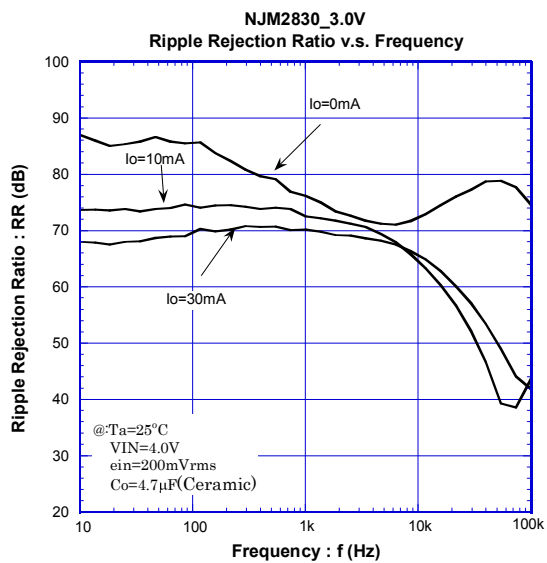
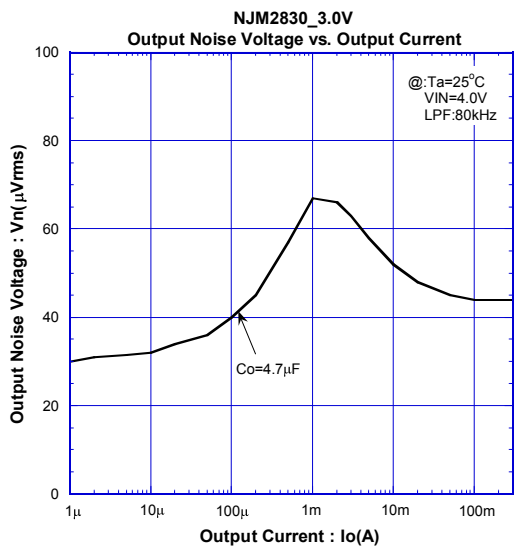

TYPICAL CHARACTERISTICS

● TEMPERATURE CHARACTERISTICS (3V Version)

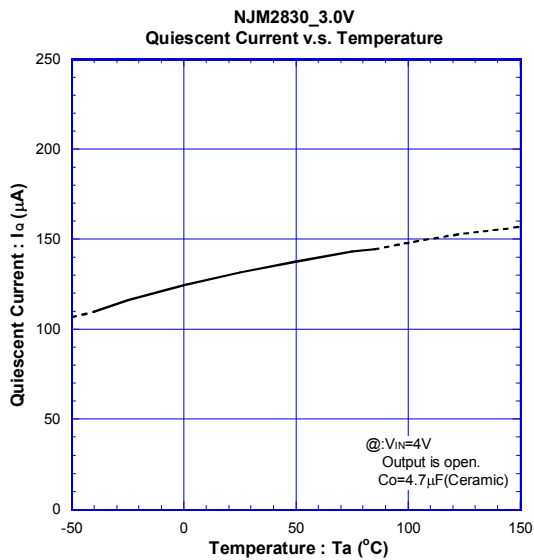
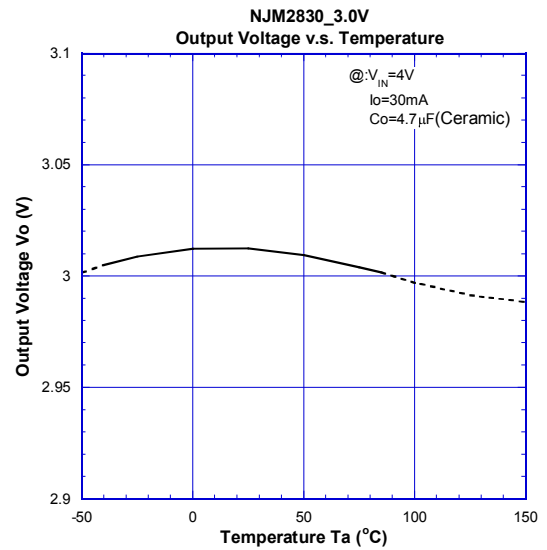
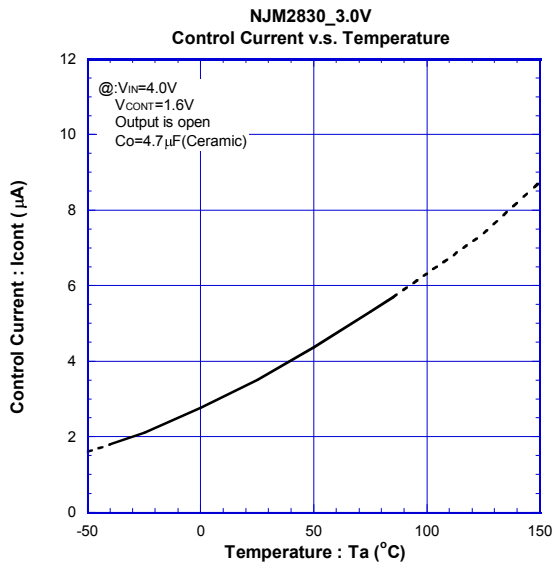
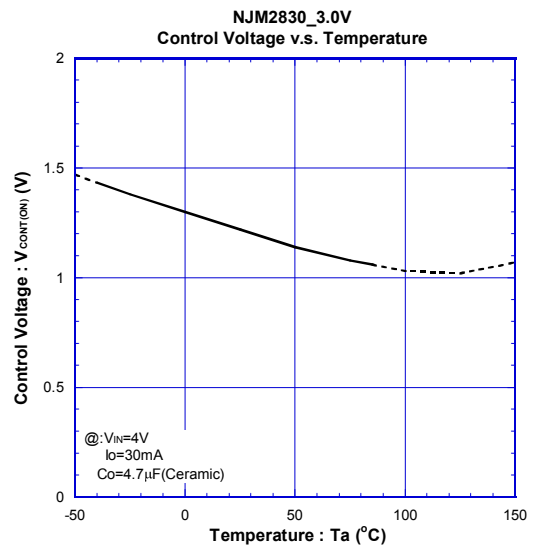
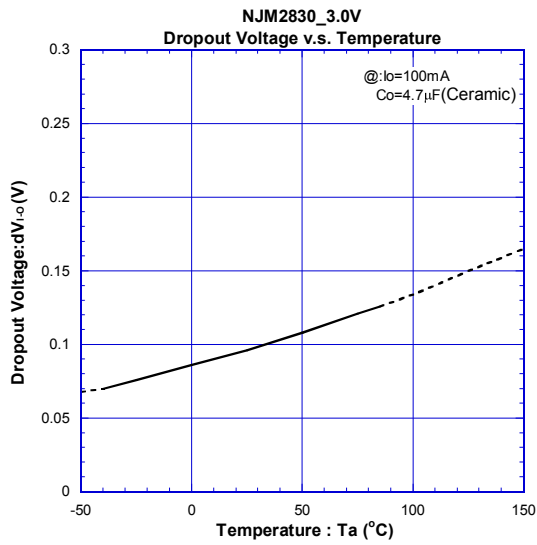

TYPICAL CHARACTERISTICS

TEMPERATURE CHARACTERISTICS (3V Version)

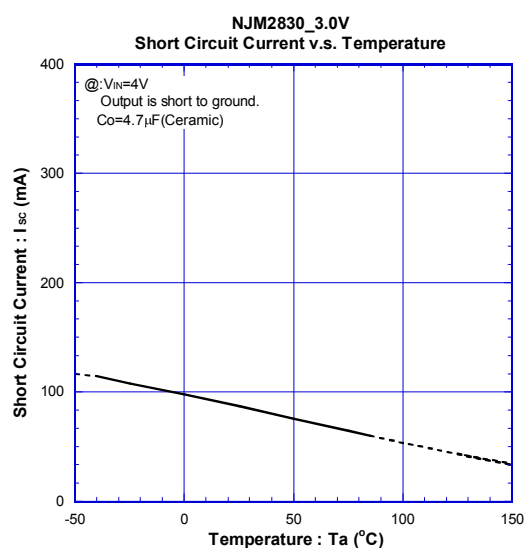
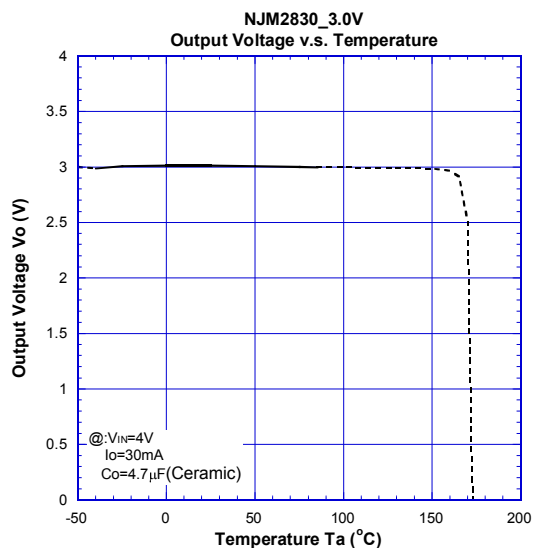
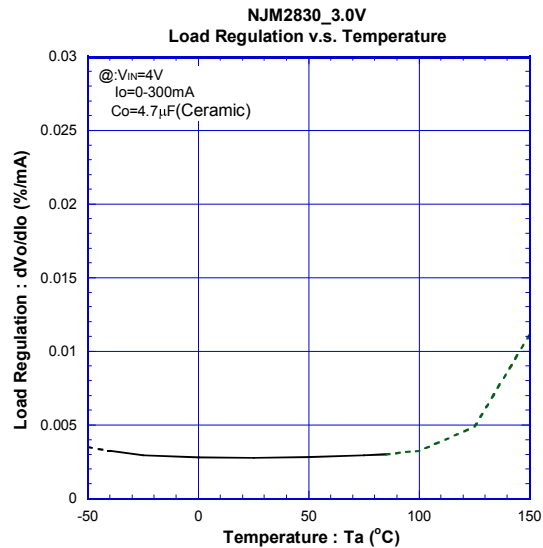
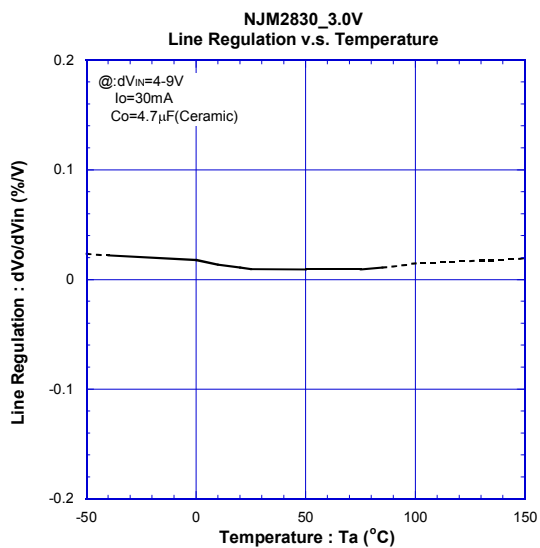

TYPICAL CHARACTERISTICS

● TRANSIENT RESPONSE (3V Version)

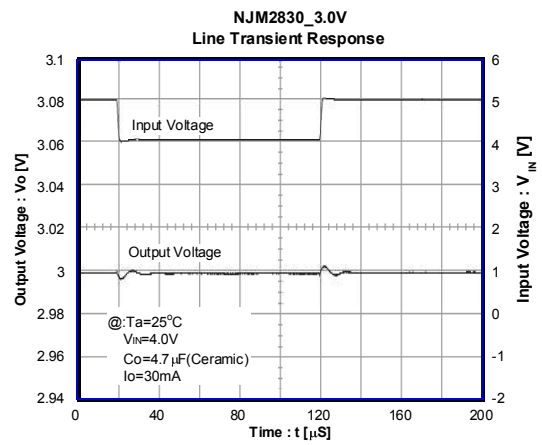
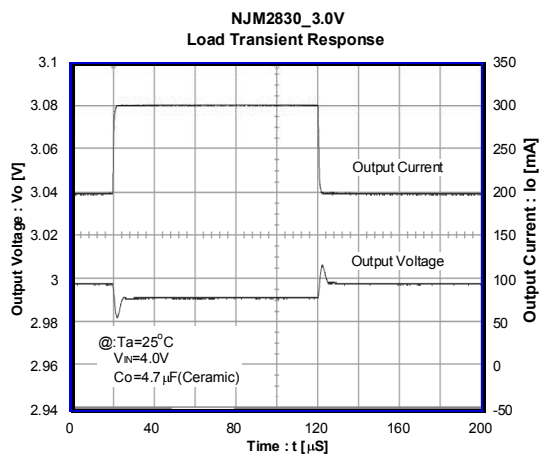
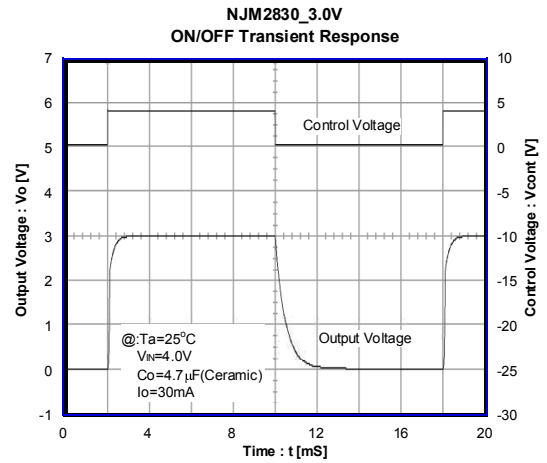
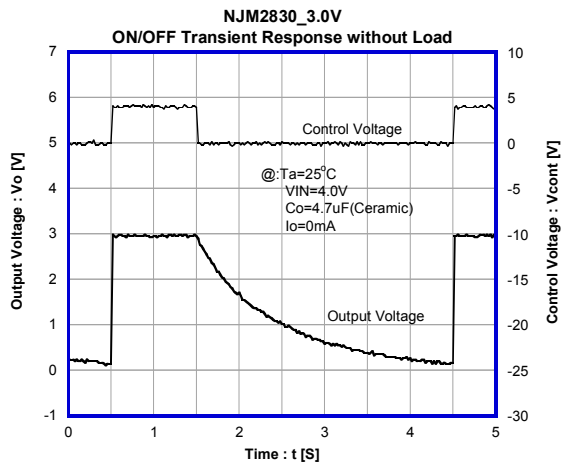

NJM2830

■ TYPICAL CHARACTERISTICS

● DC CHARACTERISTICS (8.5V Version)

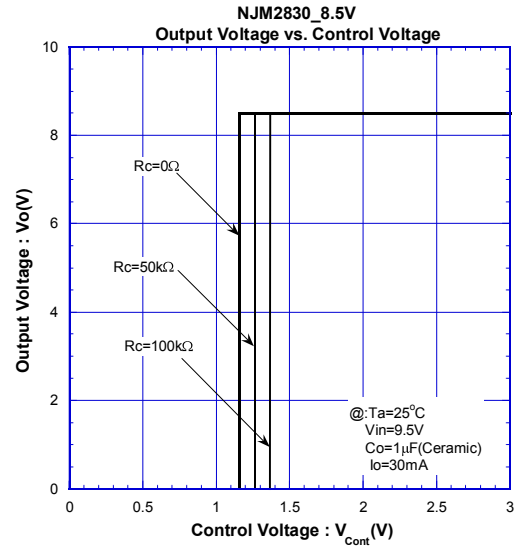
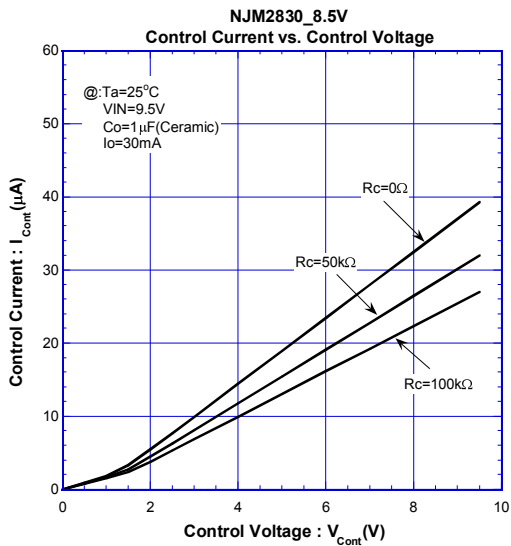
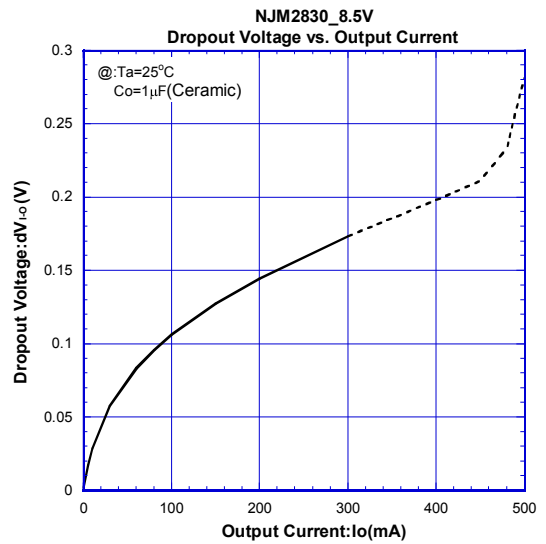
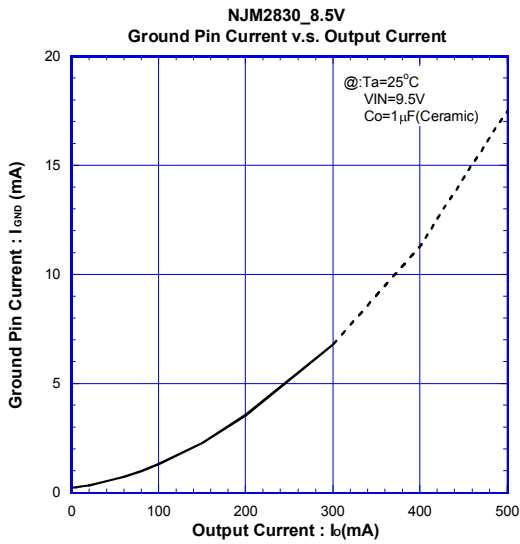
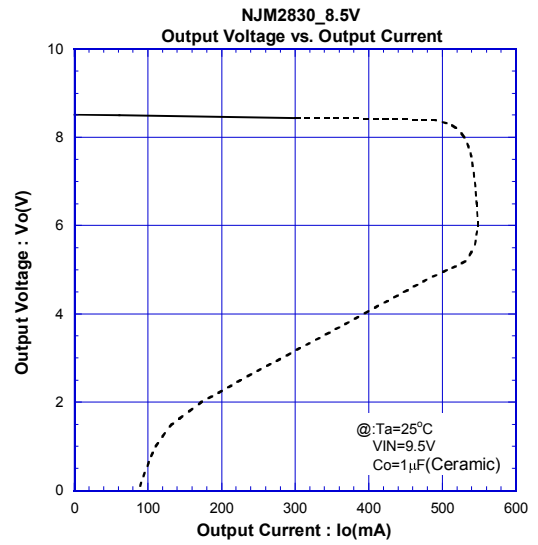
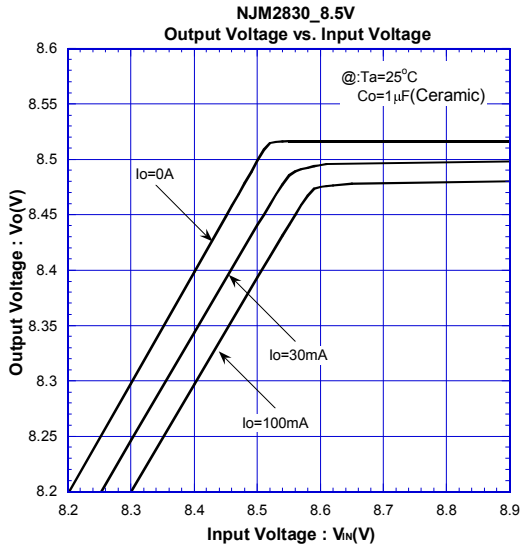

TYPICAL CHARACTERISTICS

DC CHARACTERISTICS (8.5V Version)

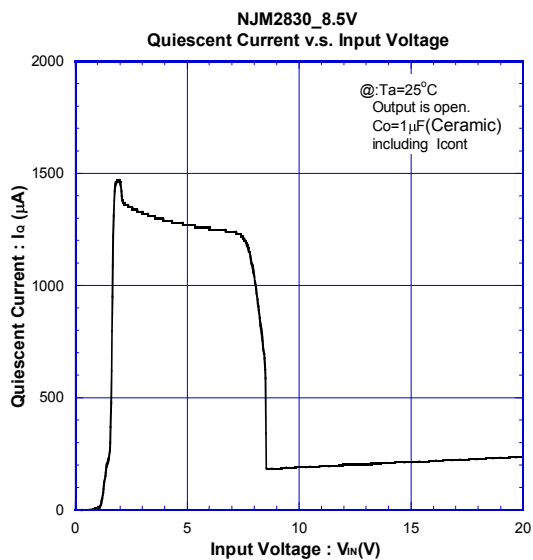
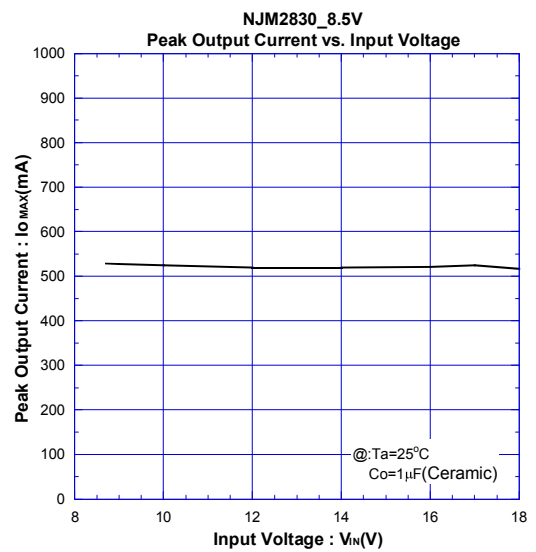
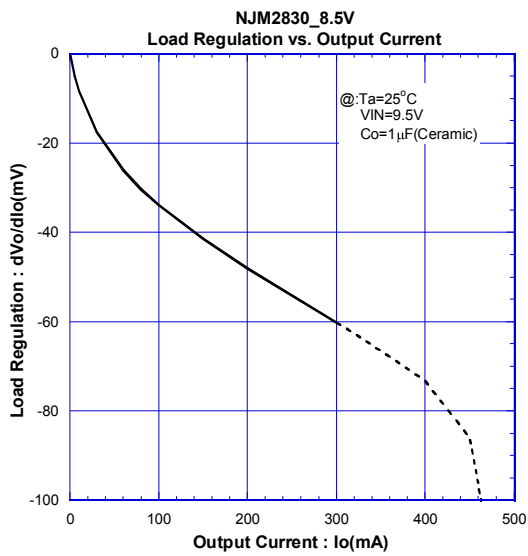

NJM2830

TYPICAL CHARACTERISTICS

AC CHARACTERISTICS (8.5V Version)

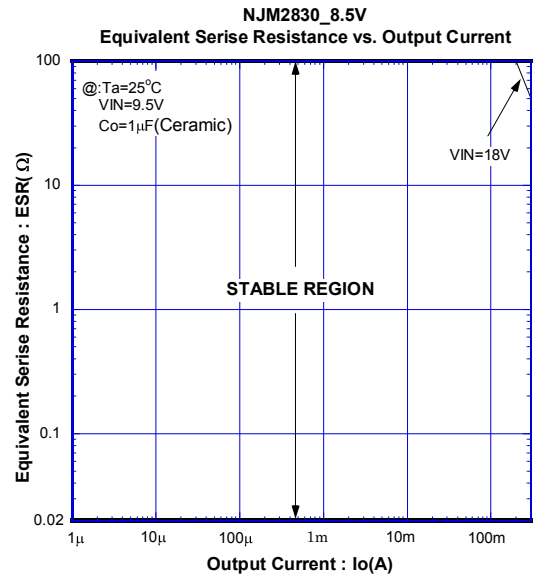
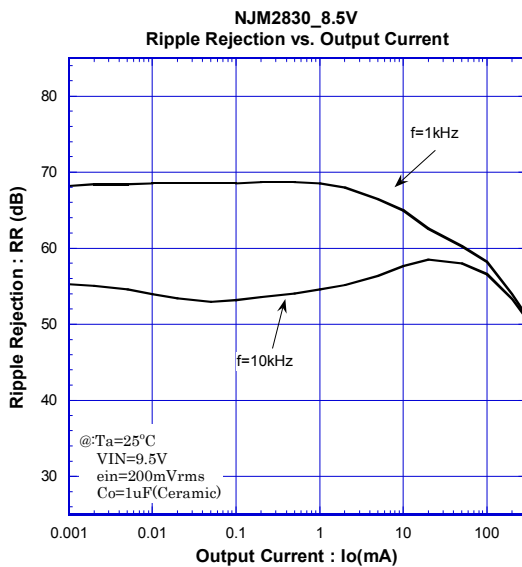
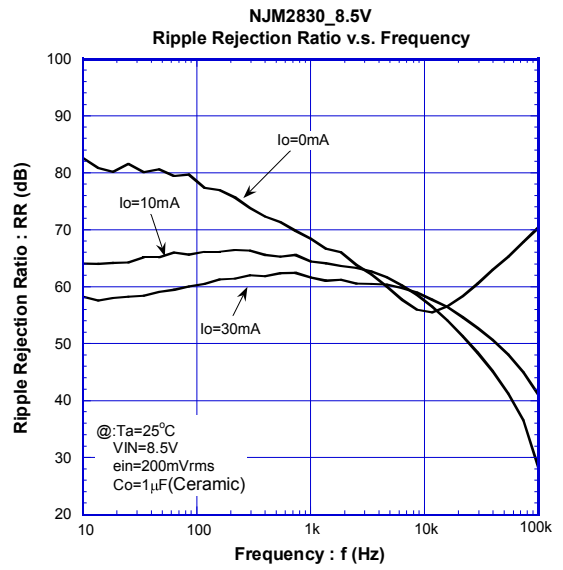
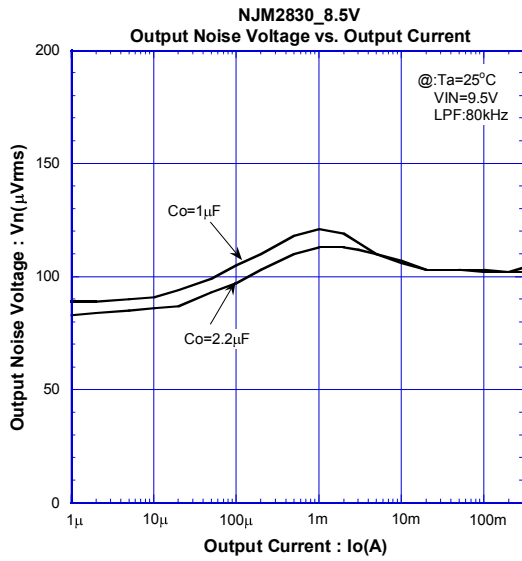

TYPICAL CHARACTERISTICS

TEMPERATURE CHARACTERISTICS (8.5V Version)

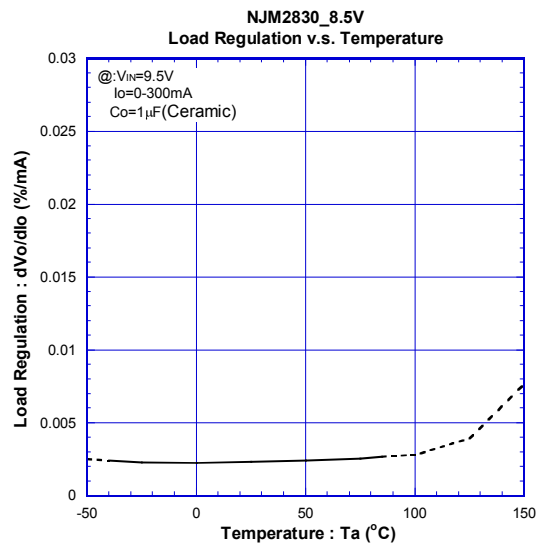
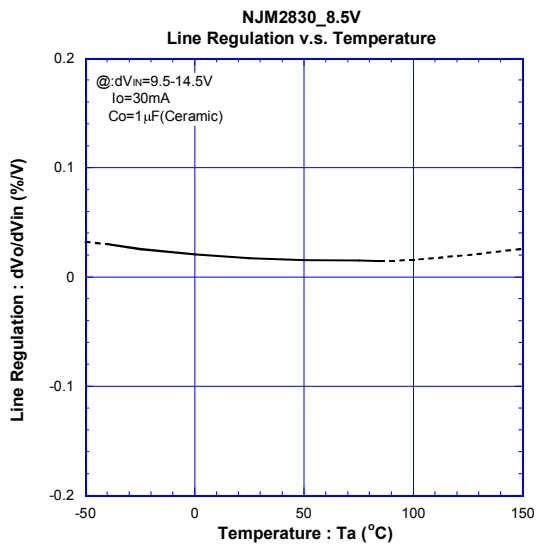
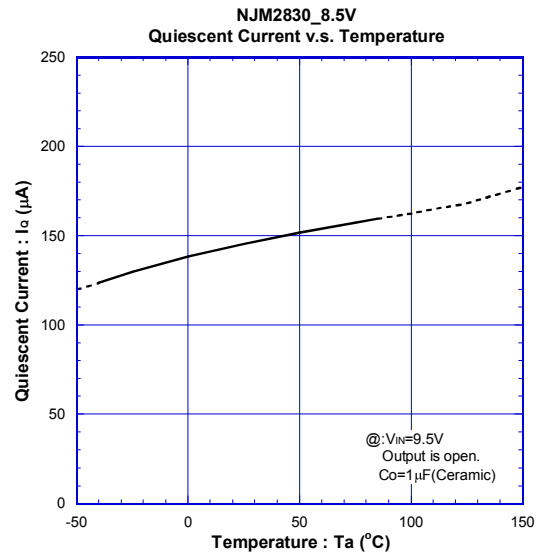
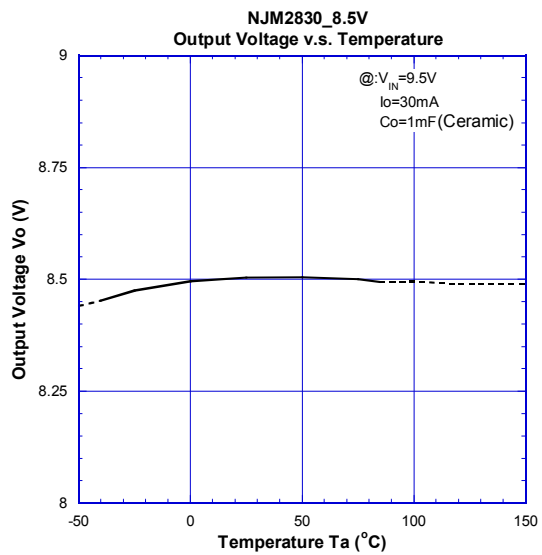
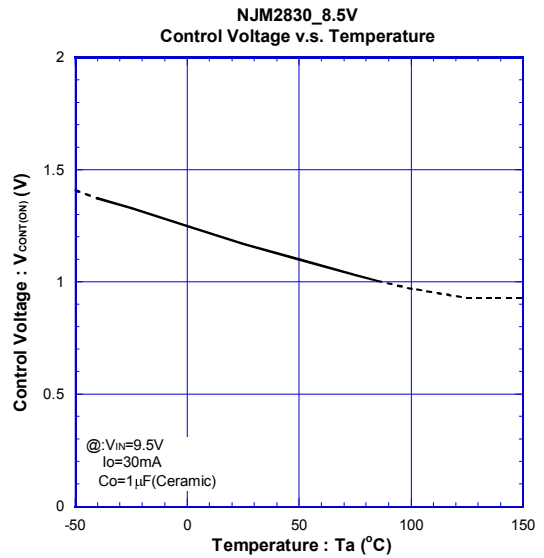
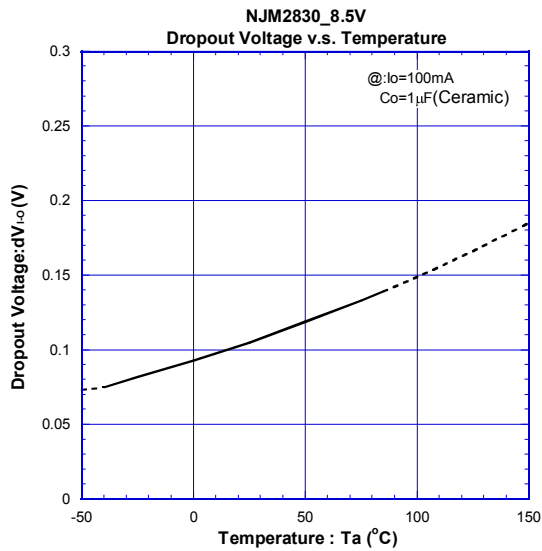

NJM2830

■ TYPICAL CHARACTERISTICS

● TEMPERATURE CHARACTERISTICS (8.5V Version)

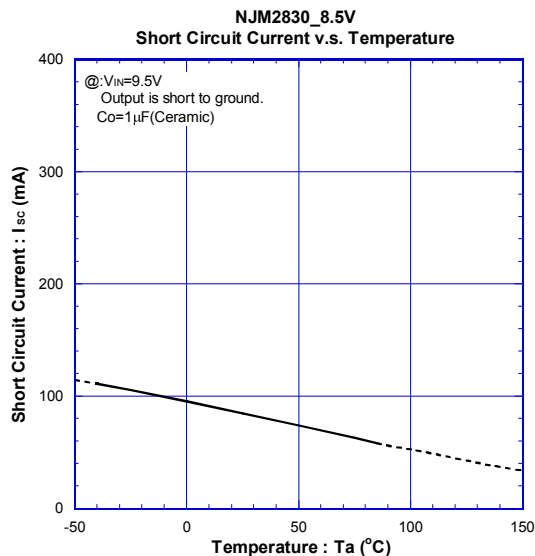
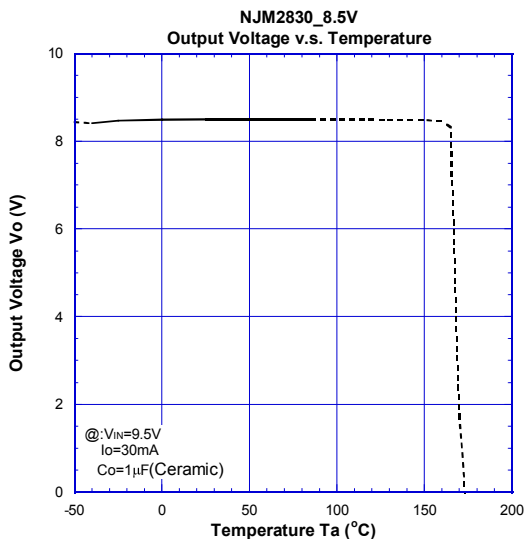

● TRANSIENT RESPONSE (8.5V Version)

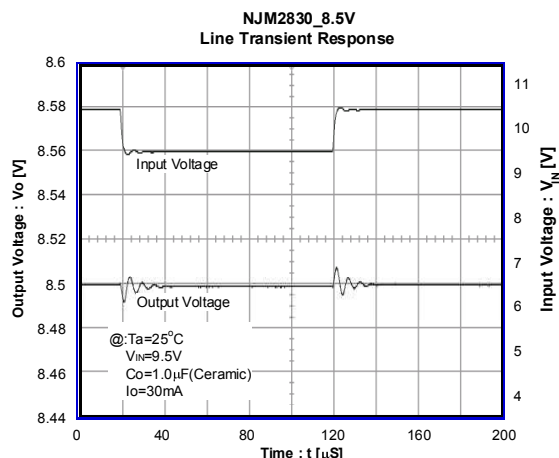
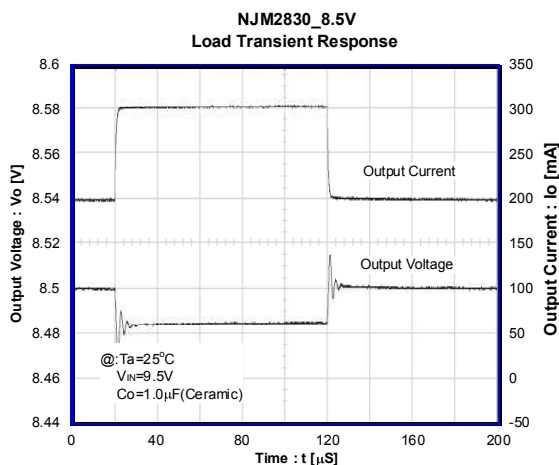
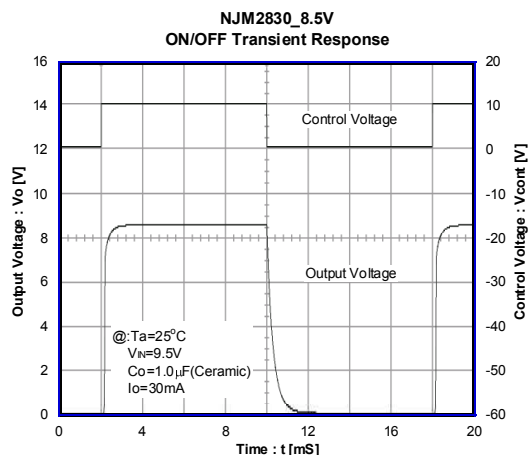
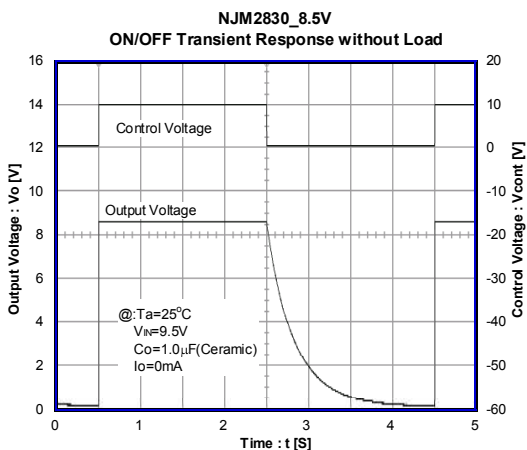

TYPICAL CHARACTERISTICS

DC CHARACTERISTICS (15V Version)

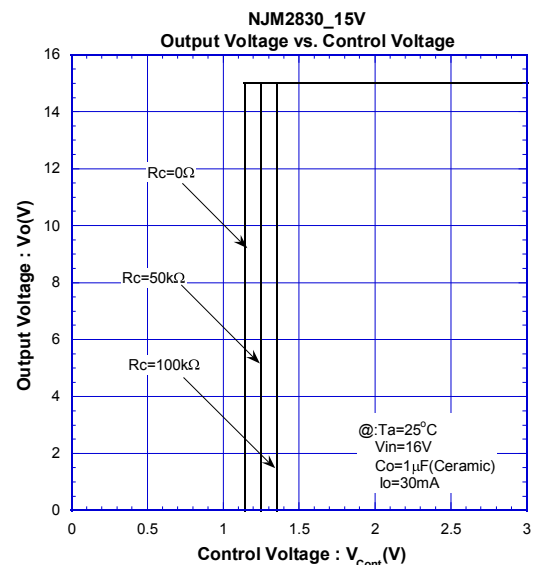
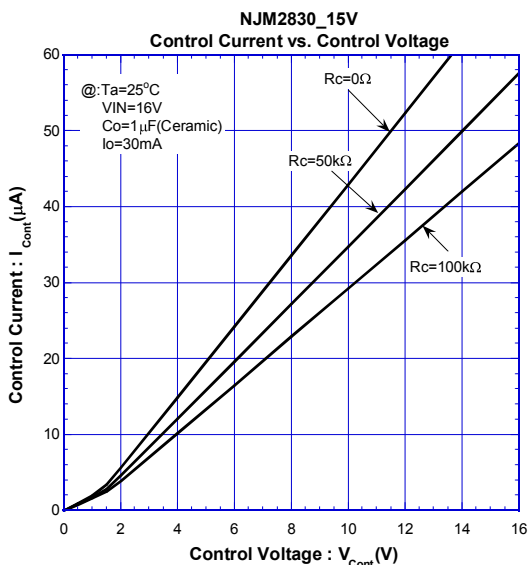
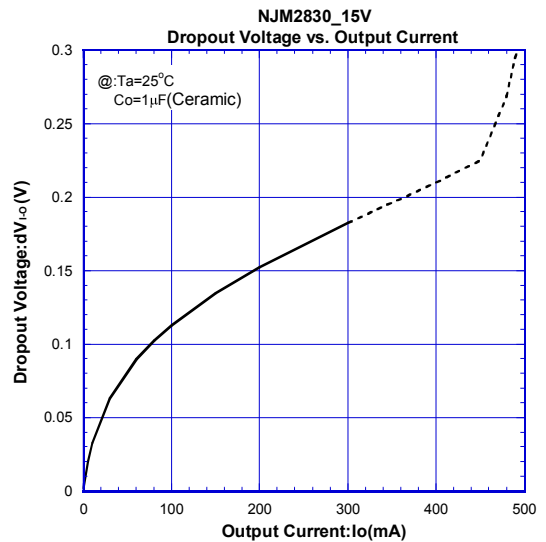
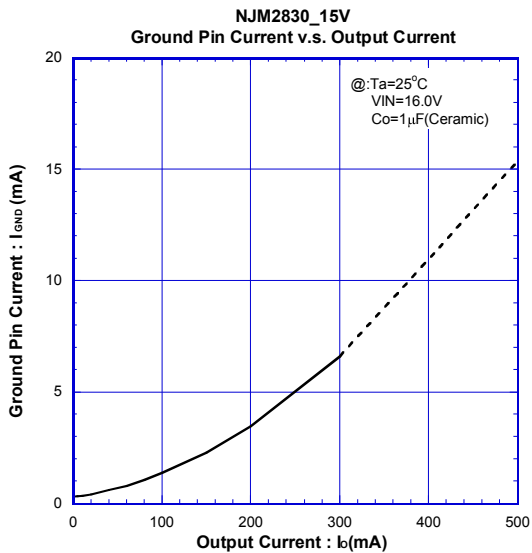
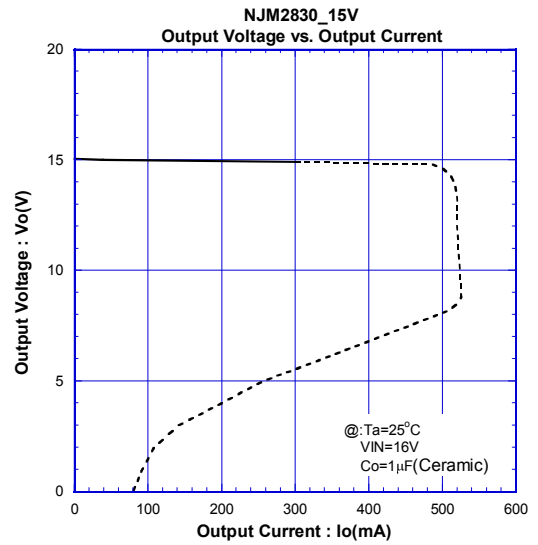
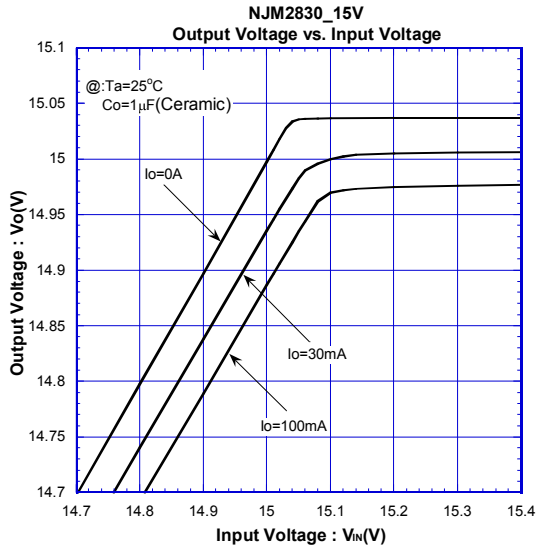

NJM2830

TYPICAL CHARACTERISTICS

DC CHARACTERISTICS (15V Version)

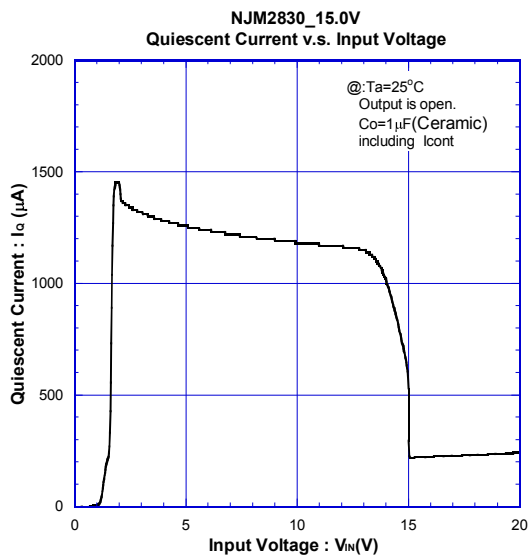
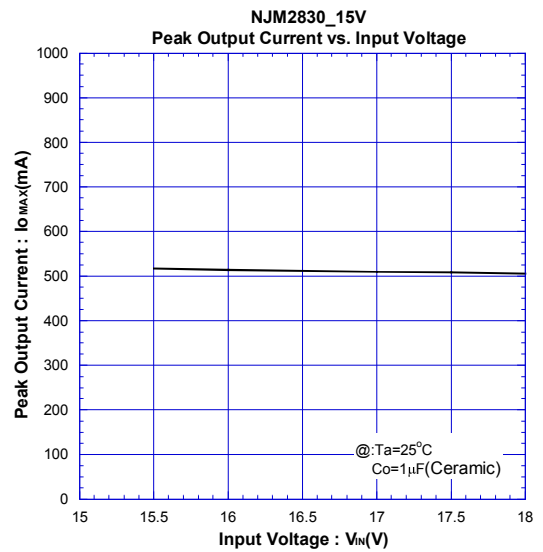
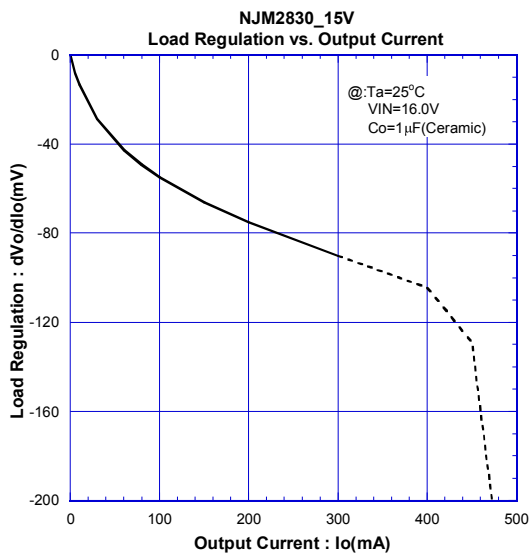

TYPICAL CHARACTERISTICS

AC CHARACTERISTICS (15V Version)

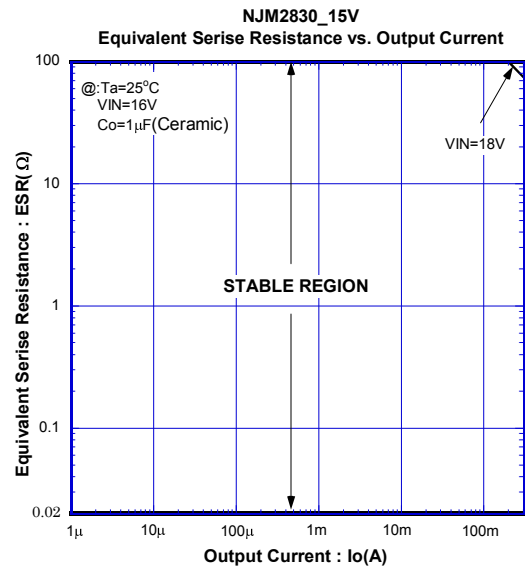
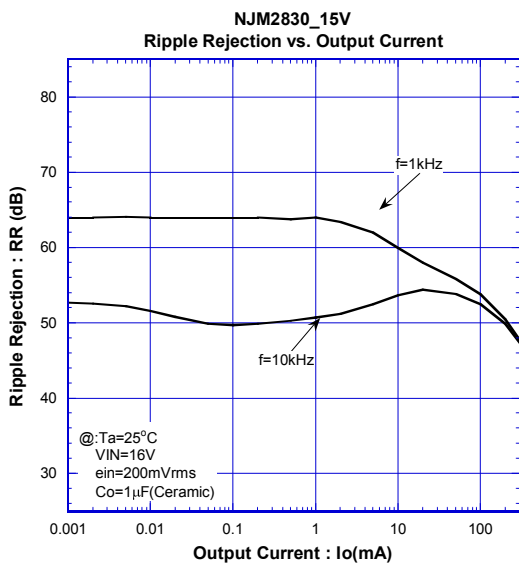
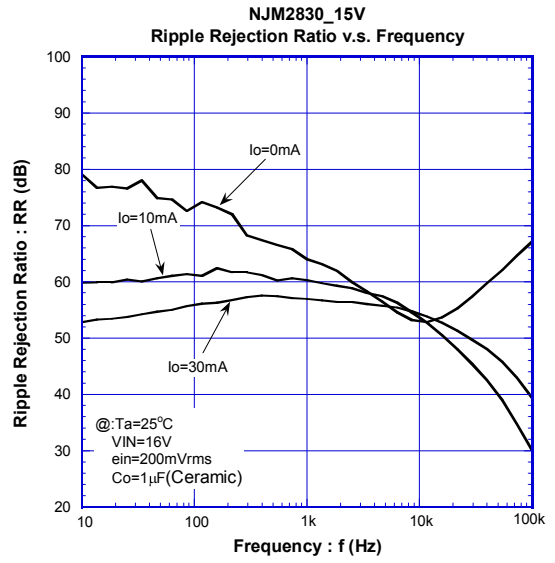
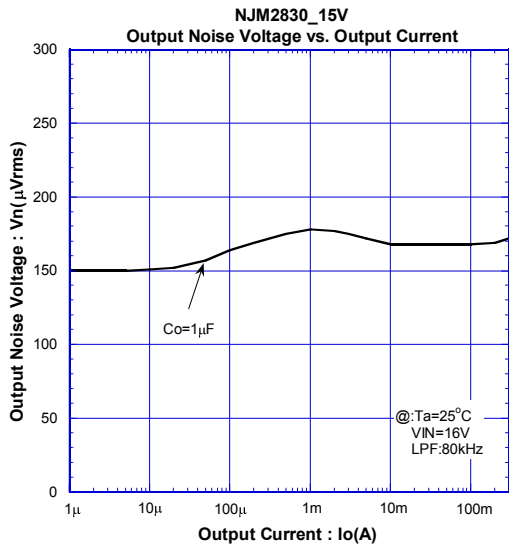

NJM2830

TYPICAL CHARACTERISTICS

TEMPERATURE CHARACTERISTICS (15V Version)

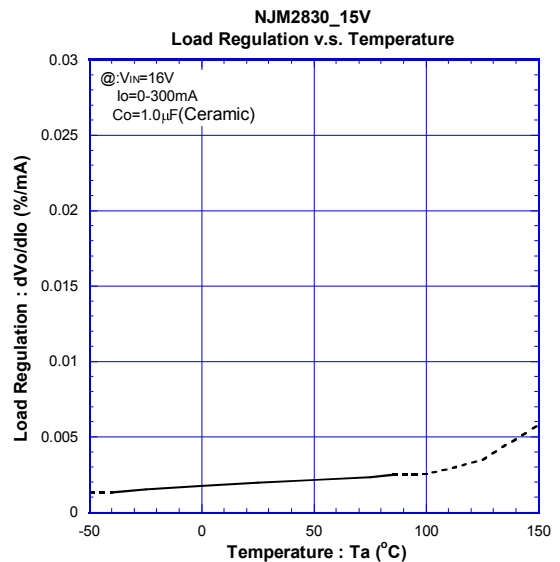
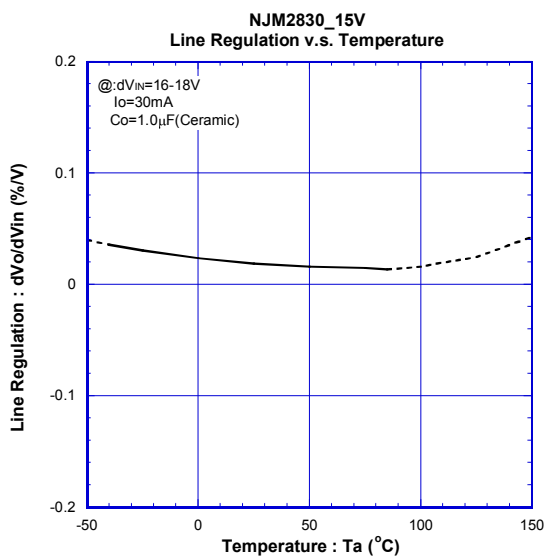
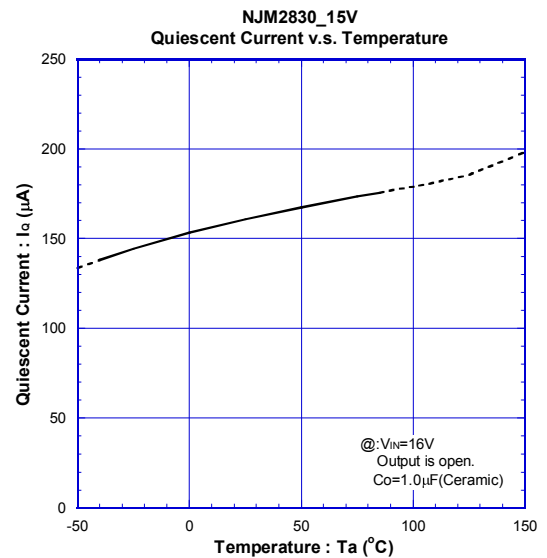
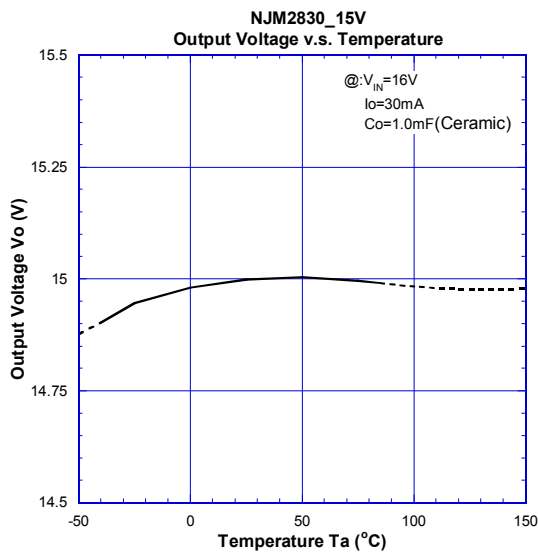
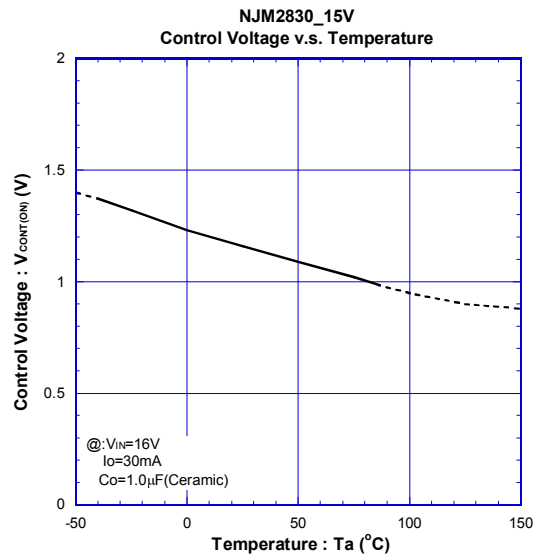
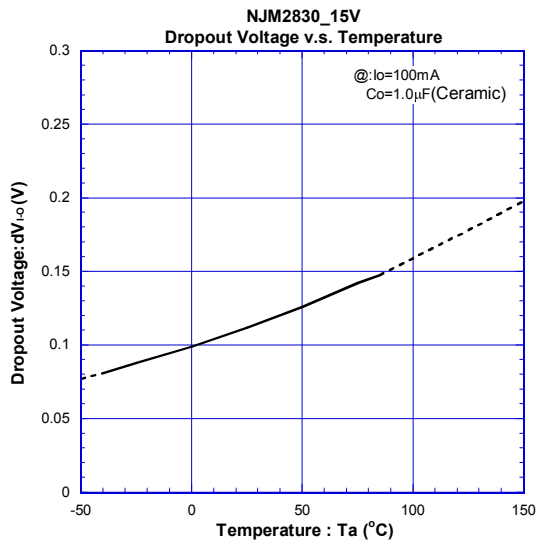

TYPICAL CHARACTERISTICS

TEMPERATURE CHARACTERISTICS (15V Version)

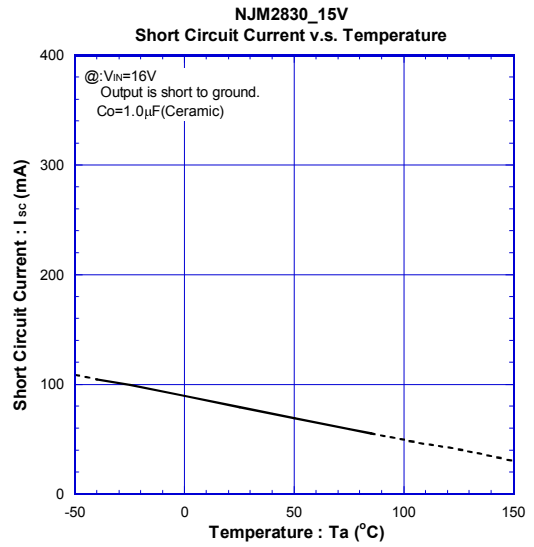
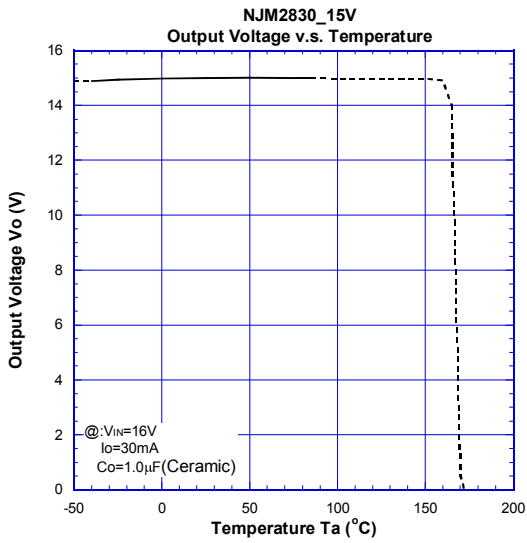

TRANSIENT RESPONSE (15V Version)

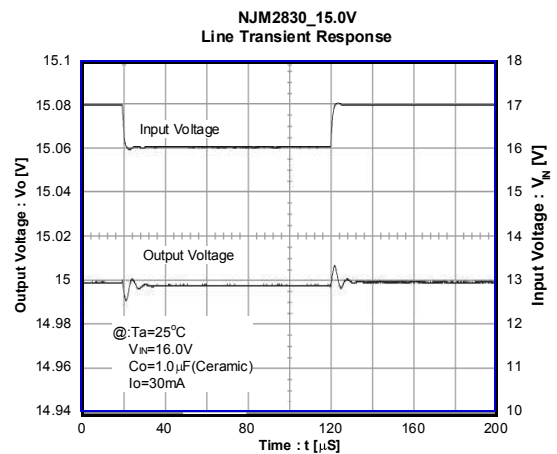
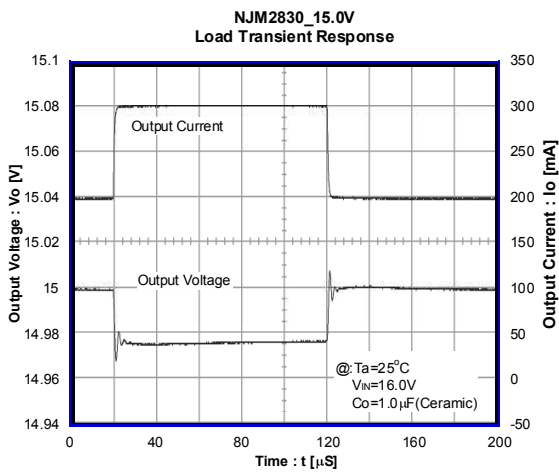
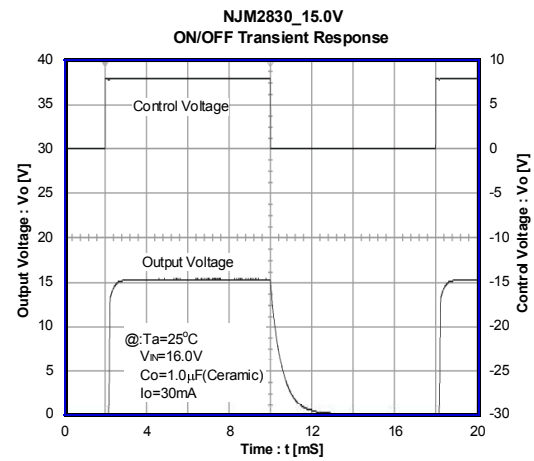
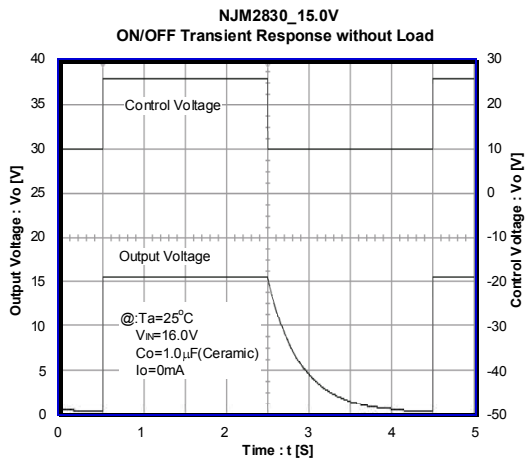

[CAUTION]

The specifications on this databook are only given for information, without any guarantee as regards either mistakes or omissions. The application circuits in this databook are described only to show representative usages of the product and not intended for the guarantee or permission of any right including the industrial rights.

Mouser Electronics

Authorized Distributor

Click to View Pricing, Inventory, Delivery & Lifecycle Information:

[NJR:](#)

[NJM2830U1-TE1](#) [NJM2830U1-05-TE1](#) [NJM2830U1-03-TE1](#) [NJM2830U1-09-TE1](#) [NJM2830U1-12-TE1](#)
[NJM2830U1-33-TE1](#) [NJM2830U1-15-TE1](#) [NJM2830U1-25-TE1](#) [NJM2830U1-06-TE1](#) [NJM2830U1-58-TE1](#)
[NJM2830U1-85-TE1](#) [NJM2830U1-08-TE1](#) [NJM2830U1-21-TE1](#) [NJM2830U1-57-TE1](#) [NJM2830U1-86-TE1](#)